

CHANDRA DYNAMO



TRACK LIGHTING

Track Fixture

The CHANDRA series track lighting fixture is specifically designed for the retail environment. It distinguishes itself with its sleek look, variety of optical options, and a series of accessories to adapt to every possible scenario. The installation of accessories on this product is simply a breeze. This enables fast deployment of fixtures around stores for reconfigurations of products. This product comes at standard 90 CRI, but also caters for lighting experts with a high-GAI (Gamut Area Index) option for an enhanced visual effect on products.

eralux



DATE						
PROJECT NAME						
TYPE						
QTY						
ORDERING CODE	AE-TL-CD12	NF	N30	J1	WH	- DYN

OPERATING & ELECTRICAL

INPUT VOLTAGE	120 V
POWER FACTOR	0.9
DIMMING	Triac dimming
TOTAL HARMONIC DISTORTION (THD)	<20%

PERFORMANCE

LUMENS PER WATT	~111 LPW at 80CRI 2000 lumens at 3000K
POWER CONSUMPTION	18W
DISTRIBUTION	Narrow flood (15 deg)

MECHANICAL & HOUSING

HOUSING	Aluminum die cast
LENS	Highly durable polycarbonate and high transmittance lens
FINISH	White
POWER SUPPLY	Factory wired electronic LED driver
LED BOARD	COB

APPLICATION CONDITION

AMBIENT TEMPERATURE RANGE	-10 °C to 35°C
---------------------------	----------------

COMPATIBLE MOUNTING

MOUNTING

Juno
Global
Halo
Lightlier

WARRANTY

SYSTEM WARRANTY – 5 YEARS

Eralux will warrant defective drivers, LEDs and boards for 10 years from the date of purchase. This warranty is valid only if the fixture is installed and used as per installation guides and specifications. If a defect is present, Eralux will send drivers and boards at no fee with a thorough replacement instructions along with instructions on the return of the defective parts back to Eralux.

LUMEN MAINTENANCE – L70 at 50,000 hours

Rated for 85% initial lumen output at 50,000 hours of operation, operated at 25°C ambient temperature; per guidelines published by the Illuminating Engineering Society (IES)

DATE						
PROJECT NAME						
TYPE						
QTY						
ORDERING CODE	AE-TL-CD12	NF	N30	J1	WH	DYN

ORDERING GUIDE

EXAMPLE: AE-TL-CD12NFN30J1WH-DYN

FIXTURE FAMILY	VOLTAGE	DISTRIBUTION	CRI	CCT	ADAPTER	FINISH
AE-TL-CD	12					
AE-TL-CD Chandra Dynamo Series track light	12 120V	NF Narrow Flood light distribution 18 watts: 2000 lumens at 80CRI 3000K	N Normal 80 CRI	30 3000K CCT	J1 Juno mounting system	WH-DYN White powder coat finish BK-DYN Black powder coat finish

PRODUCT DIMENSIONS

AE-TL-CD12XXXXXXXXXX

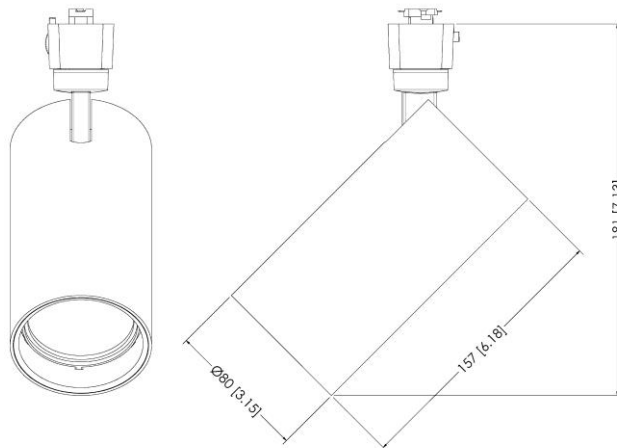

CHANDRA

TRACK LIGHTING

Track Fixture

DATE						
PROJECT NAME						
TYPE						
QTY						
ORDERING CODE	AE-TL-CD12	NF	N30	J1	WH	DYN

LUMEN ESTIMATE

Lumen output varies based on CCT and CRI. An estimate of lumen output of the various CCT/CRI combinations, use correction factors as per table below:

LUMEN ESTIMATE ADJUSTMENT FACTORS			
CCT	3000K	3500K	4000K
PREMIUM (90CRI)	1	1.03	1.06
SUPERIOR (HIGH GAI)	.90	.96	N/A

PHOTOMETRIC DATA

AE-TL-CD12WFP30XXX-DYN

GRID DISTANCES WITH A MOUNTING HEIGHT OF 10' AFG

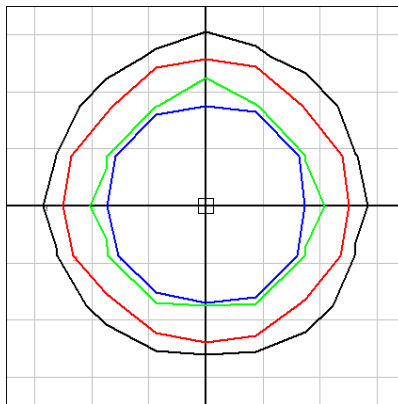

POLAR LUMINOUS INTENSITY GRAPHS

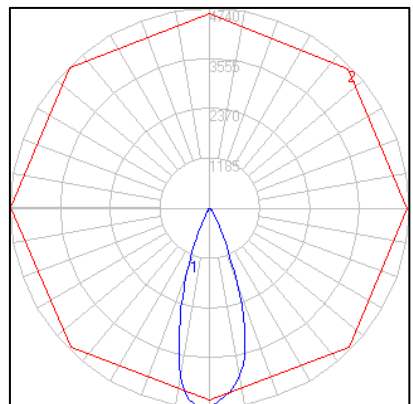

DIMMER COMPATIBILITY LIST

120 V Dimmers

MANUFACTURER	PART NUMBER
 <p>LUTRON</p>	DV-600P
	DVELV-303P
	NTELV-600
	MAELV-600
	DVLV-600P
	SELV-300P
	NFTU-5A
	CTCT-153P
	GL-600H
	S-600P
	PHPM

ACCESSORIES

Ordered separately, field installed



Hexcell Louver
AE-TL-CD-HX



Snoot
AE-TL-CD-SNT-BK
AE-TL-CD-SNT-WH

CHANDRA

TRACK LIGHTING

Track Fixture

DATE						
PROJECT NAME						
TYPE						
QTY						
ORDERING CODE	AE-TL-CD12	NF	N30	J1	WH	DYN

OVERVIEW



MULTIPLE MOUNTING ADAPTERS

Choose from any of the popular track systems such as Juno, Halo, Lightolier, or Global.

PREMIUM DESIGN

Aluminum die-cast materials selected for efficient thermal heat dissipation, enhanced structural rigidity maximizing LED life and driver function.

MULTIPLE OPTIONS

Customize your track head by selecting from a variety of beam angle, CCT, and CRI options allowing you to have a unique fixture that suits your project.

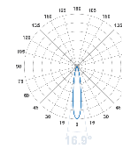
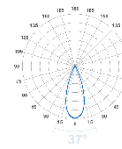
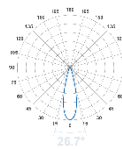

PAINT FINISH

Factory standard in black, white, and silver. Contact for custom paint finishes to enhance your fixture to suit your project space.

EFFICIENT DESIGN

Integrated components allow for small stem and clean aesthetic appearance.



ACCESSORIES

Hexcell louvers, and snoots available to help further customize your track fixtures and provide a specific look and beam distribution that your project space requires.

