

CHRONOS

OUTDOOR PRODUCTS

Sconce



eralux®



IP66



The Chronos Series differentiates itself from other outdoor cylinders through its elegant hourglass design. This wall wash up and down sconce light has IK08 protection and IP66 rated with its powder coating finish.

| | |
|---------------|-------------------------------------|
| DATE | |
| PROJECT NAME | |
| TYPE | |
| QTY | |
| ORDERING CODE | AE-OD-CR-060-8030/40/50 -3030 -CA - |

OPERATING & ELECTRICAL

| | |
|---------------------------------|---------------|
| INPUT VOLTAGE | 100-347Vac |
| POWER FACTOR | 0.9 |
| DIMMING | 0-10V dimming |
| TOTAL HARMONIC DISTORTION (THD) | <20% |

PERFORMANCE

| | |
|-------------------|-------------------------|
| LUMENS PER WATT | ~100 LPW at 80CRI |
| POWER CONSUMPTION | 60W |
| BEAM ANGLE | up & down 15°, 30°, 60° |

MECHANICAL & HOUSING

| | |
|--------------|---|
| HOUSING | Aluminum alloy |
| LENS | Highly durable, polycarbonate and glass lens ensures high efficiency light output for a clean, evenly illuminated surface with minimal glare. |
| FINISH | Black (RAL9017) and Bronze powder coat finish |
| POWER SUPPLY | Factory wired electronic LED driver |
| LED BOARD | COB |

APPLICATION CONDITION

| | |
|---------------------------|--|
| AMBIENT TEMPERATURE RANGE | -30 to 45°C |
| Surge Protection | 2kV line-line, 2kV line-earth 4kV line-line, 5kV line-earth |
| Protection | IP66 IK08 |

COMPATIBLE MOUNTING

| | |
|----------|---------------|
| MOUNTING | Surface Mount |
|----------|---------------|

WARRANTY

SYSTEM WARRANTY – 5 YEARS

Eralux will warrant defective drivers, LEDs and boards for 5 years from the date of purchase. This warranty is valid only if the fixture is installed and used as per installation guides and specifications. If a defect is present, Eralux will send drivers and boards at no fee with a thorough replacement instructions along with instructions on the return of the defective parts back to Eralux.

LUMEN MAINTENANCE – L90 at 40,000 hours

Rated for 85% initial lumen output at 40,000 hours of operation, operated at 25°C ambient temperature; per guidelines published by the Illuminating Engineering Society (IES). (L85 at 50,000 hours)

| | | | |
|---------------|-------------------------|-------|-------|
| DATE | | | |
| PROJECT NAME | | | |
| TYPE | | | |
| QTY | | | |
| ORDERING CODE | AE-OD-CR-060-8030/40/50 | -3030 | -CA - |

ORDERING GUIDE

EXAMPLE: AE-OD-CR-060-8030/40/50-1515-CA-BZ

| FIXTURE FAMILY | POWER | CRI | CCT | BEAM ANGLE | | VOLTAGE | CONTROL | FINISH |
|---|--|---------------|--|-------------------------|---------------------------|-------------------|---------------------------------|----------------------------------|
| AE-OD-CR | -060 | -80 | 30/40/50 | -30 | 30 | -CA | - | - |
| ERALUX CHRONOS outdoor surface mounted sconce fixture | -060 Power switchable: 18W/30W/45W/60W | -80 80 CRI | 30/40/50 3000K/4000K/5000K CCT selectable | 30 30° up beam angle | 30 30° down beam angle | -CA 120 – 347V | -[LEAVE BLANK] 0-10V dimming | -BZ Bronze powder coat finish |
| | | | | | | | -PH Photocell control option | -BK Black powder coat finish |

DIMENSIONS

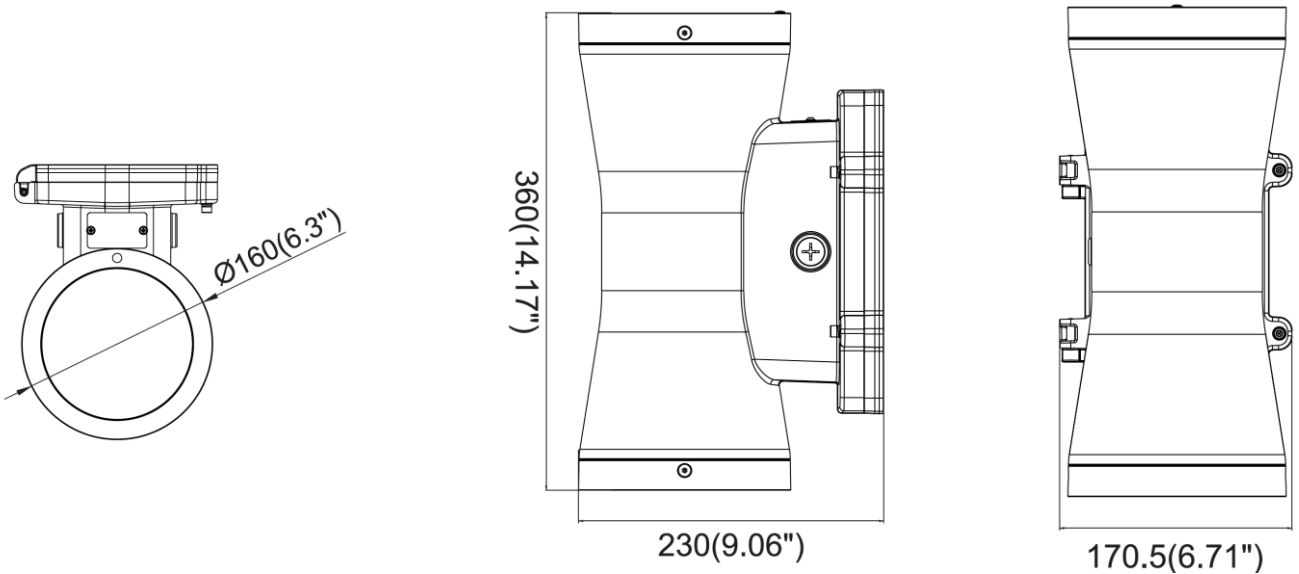

| | | | |
|---------------|-------------------------|-------|-------|
| DATE | | | |
| PROJECT NAME | | | |
| TYPE | | | |
| QTY | | | |
| ORDERING CODE | AE-OD-CR-060-8030/40/50 | -3030 | -CA - |

LUMEN ESTIMATE

Lumen output varies based on CCT and CRI. An estimate of lumen output of the various CCT/CRI combinations, use correction factors as per table below:

| LUMEN ESTIMATE ADJUSTMENT FACTORS | | | | |
|-----------------------------------|-------|-------|-------|-------|
| CCT | 2700K | 3000K | 3500K | 4000K |
| PREMIUM (90CRI) | 0.91 | 1 | 1.02 | 1.03 |

PHOTOMETRIC DATA

GRID DISTANCES WITH A MOUNTING HEIGHT OF 10' AFG

POLAR LUMINOUS INTENSITY GRAPHS

AE-OD-CR-060-30-BZ
AT 20W 4000K

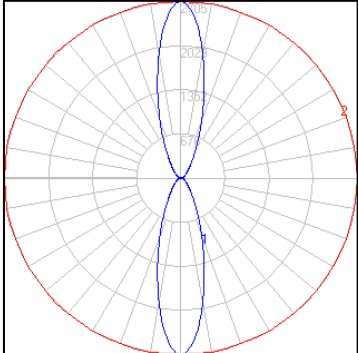
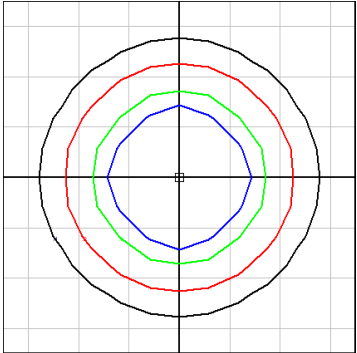

AE-OD-CR-060-30-BZ
AT 40W 4000K

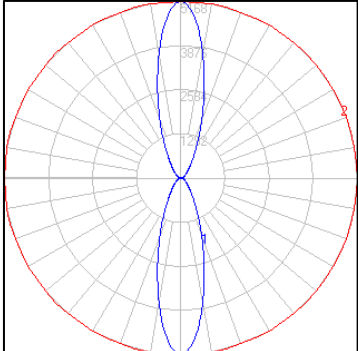
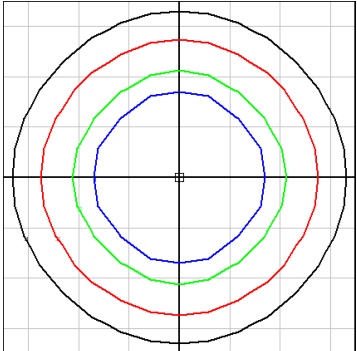

AE-OD-CR-060-30-BZ
AT 60W 4000K

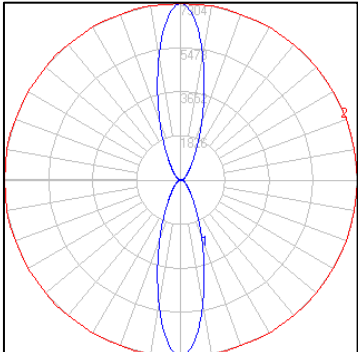
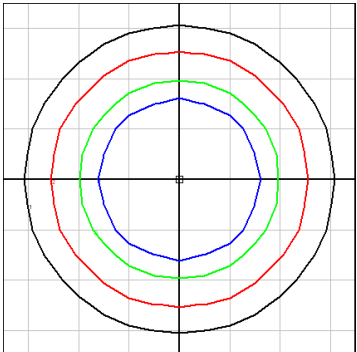

| | | | | |
|---------------|-------------------------|-------|-----|---|
| DATE | | | | |
| PROJECT NAME | | | | |
| TYPE | | | | |
| QTY | | | | |
| ORDERING CODE | AE-OD-CR-060-8030/40/50 | -3030 | -CA | - |

ACCESSORIES

Ordered separately, field installed

EMERGENCY LED DRIVER (BLD-CM20N-480800-8W)

BLD-CM20N-480800-8W

OUTPUT POWER : 8 WATTS



- Easy Wiring
- Certified For CA Title 20
- Constant Power Performance

BLD-CM20N-480800-8W LED Emergency Driver is UL listed for field and factory installation that allows the same LED fixture to be used for both normal and emergency operation. In the event of a power failure, the emergency driver switches to emergency mode and operates the fixture for 90 minutes. The unit contains a battery, charge, and converter circuit in a single enclosure. This module will operate a LED array load at 8W with constant power at a rated output voltage of 25-48 VDC. The constant power design of BLD-CM20N-480800-8W maintains the output wattage to the LED array, providing consistent illumination for the entire emergency runtime. Its slim shape is ideal for use indoor or outdoor LED lighting fixtures, such as linear lights, wall packs or sconces, etc.

DIMENSIONS (inches and mm)

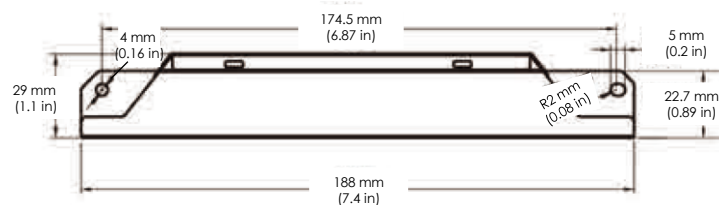
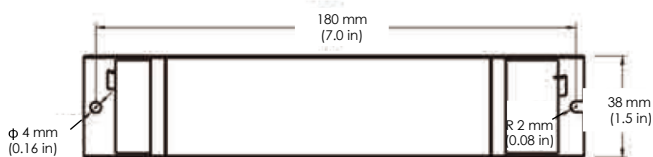

| | | | | |
|---------------|-------------------------|-------|-----|---|
| DATE | | | | |
| PROJECT NAME | | | | |
| TYPE | | | | |
| QTY | | | | |
| ORDERING CODE | AE-OD-CR-060-8030/40/50 | -3030 | -CA | - |

OVERVIEW



MODERN DESIGN

The wall mounted up and down light fixture with an hourglass shape will brighten up spaces elegantly.

SWITCHABLE POWERS AND CCT

Available in 18W, 30W, 45W and 60W power consumptions and 3000K, 4000K and 5000K CCT options to choose from.

INCREDIBLE PROTECTION

To ensure the protection of the fixture, the Chronos is IP66 and IK08 rated.



CRI

80 CRI provides greater rendering allowing for a more natural light look.

