

F2

LINEAR SURFACE MOUNT

Linear Architectural Lighting



The F2 series is the surface mount linear architectural lighting fixture from ERALUX. The F2 Series offers the simplicity of installation for a fast and efficient delivery. It is further enhanced with the access to the led board, drivers and any other components from below. They are available in 4-, 6- and 8-feet lengths. The CCT switchable switch also enables a rapid change of lighting environment.

eralux®



DATE	
PROJECT NAME	
TYPE	
QTY	
ORDERING CODE	AE-SF-F2- 30/40/CCT-

OPERATING & ELECTRICAL

INPUT VOLTAGE	120-277V
POWER FACTOR	0.9
DIMMING	1-10V
TOTAL HARMONIC DISTORTION (THD)	<20%

PERFORMANCE

LUMENS PER FEET	750lm/ft
POWER	23W
	31W
	46W
	61W
BEAM ANGLE	Lambertian

MECHANICAL & HOUSING

HOUSING	Extruded aluminum
LENS	PC lens
FINISH	Nebula White Atomic Black Silver
POWER SUPPLY	Factory wired electronic LED driver
LED BOARD	LED Array

APPLICATION CONDITION

AMBIENT TEMPERATURE RANGE	-20°C to 45°C
---------------------------	---------------

COMPATIBLE MOUNTING

MOUNTING	Surface Mount
----------	---------------

WARRANTY

SYSTEM WARRANTY – 5 YEARS

Eralux will warrant defective drivers, LEDs and boards for 5 years from the date of purchase. This warranty is valid only if the fixture is installed and used as per installation guides and specifications. If a defect is present, Eralux will send drivers and boards at no fee with a thorough replacement instructions along with instructions on the return of the defective parts back to Eralux.

LUMEN MAINTENANCE – L85 at 50,000 hours

Rated for 85% initial lumen output at 50,000 hours of operation, operated at 25°C ambient temperature; per guidelines published by the Illuminating Engineering Society (IES).

DATE				
PROJECT NAME				
TYPE				
QTY				
ORDERING CODE	AE-SF-F2-	-	-30/40/CCT-	

ORDERING GUIDE

EXAMPLE: AE-SF-F2-4-31-30/40/CCT-BK

FIXTURE FAMILY	LENGTH	POWER	CCT	FINISH
AE-SF-F2-		-	-30/40/CCT-	
AE-SF-F2- ERALUX F2 surface mount linear architectural fixture	3 3 Feet	-23 23W-2,300 lumens	-30/40/CCT- CCT Switchable: 3000K/3500K/4000K	BK Atomic Black Finish
	4 4 Feet	-31 31W-3,000 lumens		WH Nebula White Finish
	6 6 Feet	-46 46W-4,500 lumens		SV Silver Finish
	8 8 Feet	-61 61W-6,000 lumens		RALXXXX Custom Colour

FIXTURE FAMILY	SHAPE	CCT	FINISH
AE-SF-F2-		-30/40/CCT-	
AE-SF-F2- ERALUX F2 surface mount linear architectural fixture	L-90L L Shape 31W – 3,000 lumens	-30/40/CCT- CCT Switchable: 3000K/3500K/4000K	BK Atomic Black Finish
	T- T Shape 46W – 4,500 lumens		WH Nebula White Finish
	X- X Shape 61W – 6,000 lumens		RALXXXX Custom Colour

CAUTION: If there are multiple fixtures connected to the same 0-10V dimming line, a 0-10V controller must be considered to enable consistent dimming across the fixtures. Failure to do so will lead to inconsistent dimming and behaviors in the fixtures. Single switch is not recommended for controlling multiple fixtures simultaneously.

PRODUCT DIMENSION

AE-SF-F2-3/4/6/8 FT

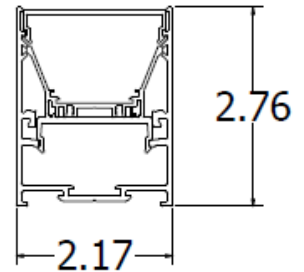
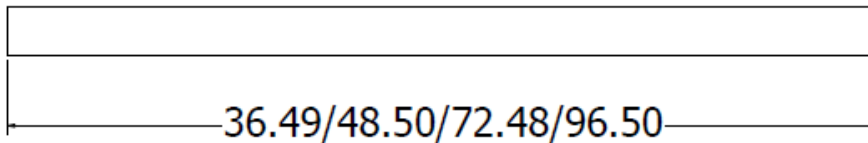

DIMENSIONS IN INCHES

DATE	
PROJECT NAME	
TYPE	
QTY	
ORDERING CODE	AE-SF-F2- 30/35/40/CCT-XX

VARIOUS SHAPES

L SHAPE

AE-SF-F2-L-90L-30/35/40/CCT-XX

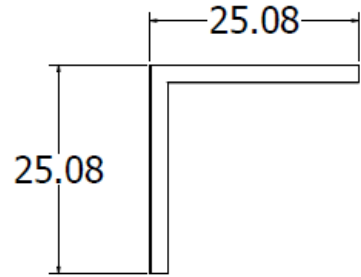
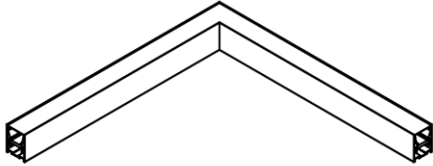

DIMENSIONS IN INCHES

T SHAPE

AE-SF-F2-T-30/35/40/CCT-XX

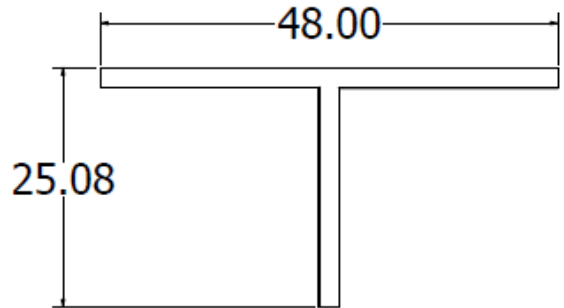
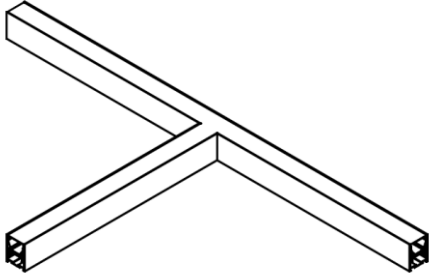

DIMENSIONS IN INCHES

X SHAPE

AE-SF-F2-X-30/35/40/CCT-XX

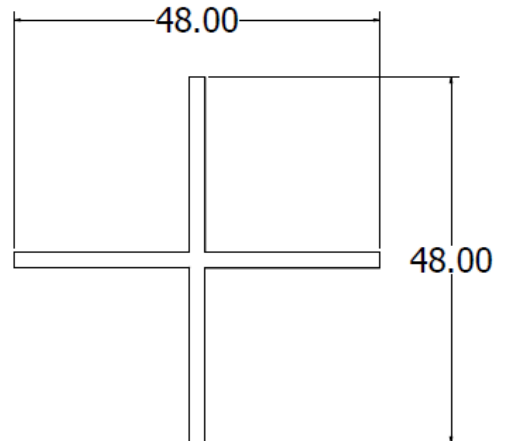
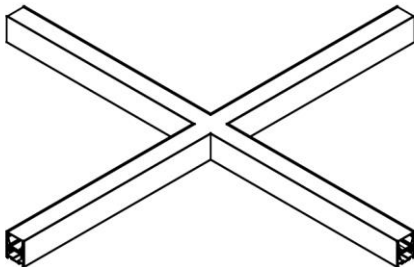

DIMENSIONS IN INCHES

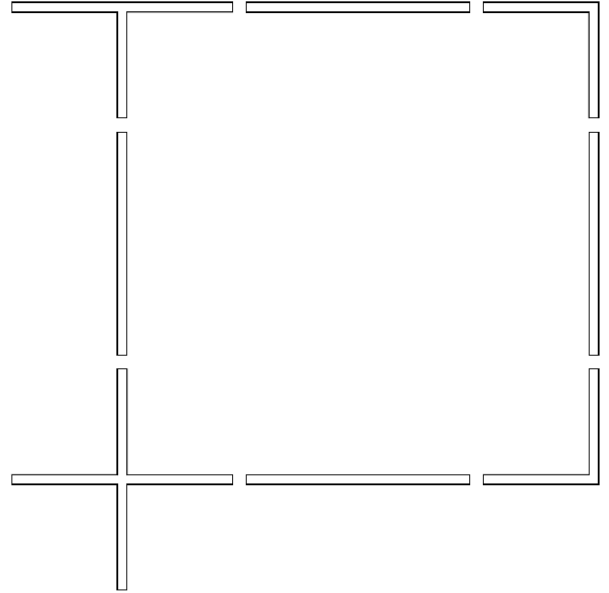
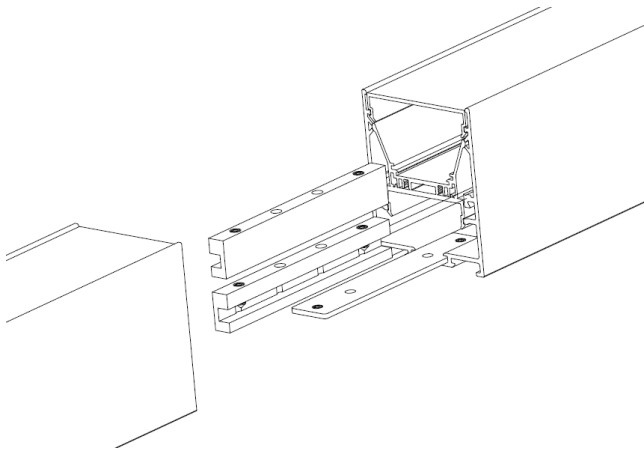

DATE			
PROJECT NAME			
TYPE			
QTY			
ORDERING CODE	AE-SF-F2-		30/40/CCT-

MULTIPLE FIXTURE ASSEMBLY



ACCESSORIES

Ordered separately, field installed

PART NUMBER	DESCRIPTION	PICTURE
AE-SF-F2-LINK-KIT	Linkable mechanical and electrical accessories for continuous mounting	
AE-SF-F2-L-DA	Rubber Diffuser Sucker and F2 Disassembly spanner	



DATE			
PROJECT NAME			
TYPE			
QTY			
ORDERING CODE	AE-SF-F2-		30/40/CCT-

ACCESSORIES (Continued)

Ordered separately, field installed

EMERGENCY LED DRIVER (BLD-YTXXD-XXX)

BLD-YT08D-XXX

OUTPUT POWER : 8 WATTS

BLD-YT15D-XXX

OUTPUT POWER : 15 WATTS



- Easy Wiring
- Certified For CA Title 20
- Constant Power Performance

BLD-YTXXD-XXX LED Emergency Driver is UL listed for field and factory installation that allows the same LED fixture to be used for both normal and emergency operation. In the event of a power failure, the emergency driver switches to emergency mode and operates the fixture for 90 minutes. This module will operate a LED array load at 8W or 15W with constant power at a rated output voltage of 30-60 VDC. The constant power design of BLD-YTXXD-XXX maintains the output wattage to the LED array, providing consistent illumination for the entire emergency runtime. Its slim shape is ideal for use in linear LED lighting fixtures.

DIMENSIONS (inches and mm)

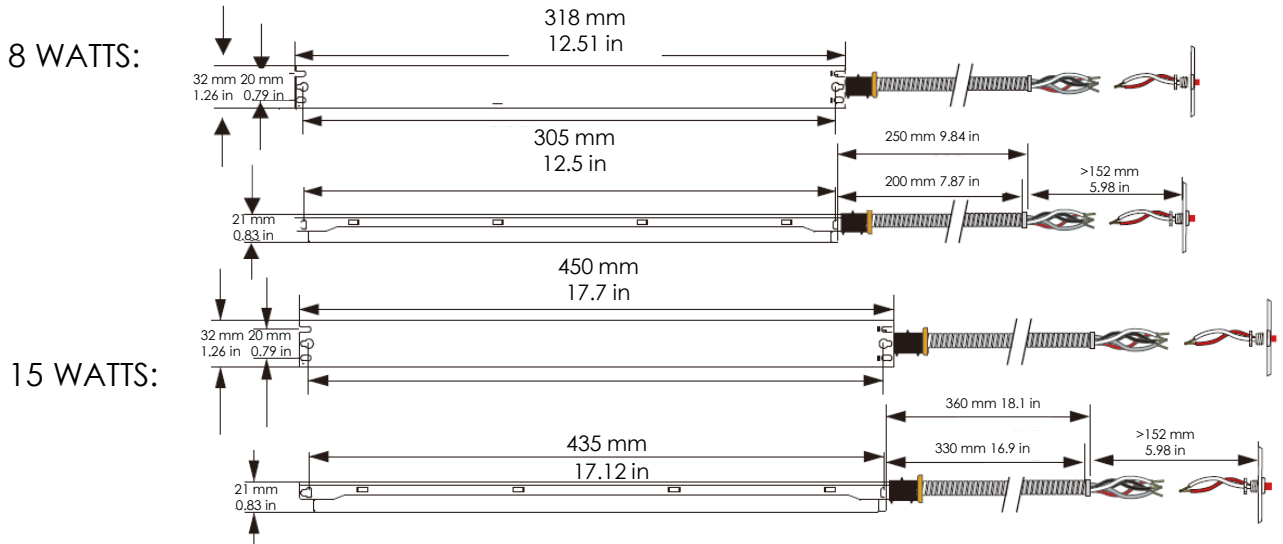

DATE				
PROJECT NAME				
TYPE				
QTY				
ORDERING CODE	AE-SF-F2-			30/40/CCT-

CUSTOMED FINISH EXAMPLES FOR F2 AIR

* Please contact manufacturer for more information and pricing for customized finishes

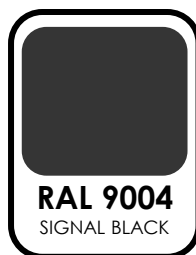
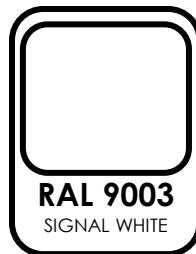
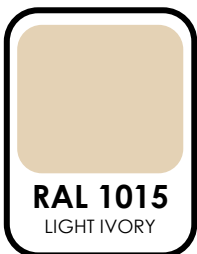
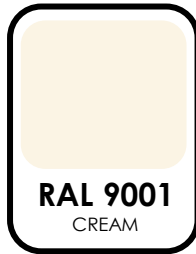

DATE			
PROJECT NAME			
TYPE			
QTY			
ORDERING CODE	AE-SF-F2-		30/40/CCT-

LUMEN ESTIMATE

Lumen output varies based on CCT and CRI. An estimate of lumen output of the various CCT/CRI combinations, use correction factors as per table below:

LUMEN ESTIMATE ADJUSTMENT FACTORS				
CCT	2700K	3000K	3500K	4000K
NORMAL(80CRI)	0.91	0.94	0.97	1

PHOTOMETRIC DATA

AE-SF-F2-4-31-30/35/40-BK
 4 FEET
 31 WATTS

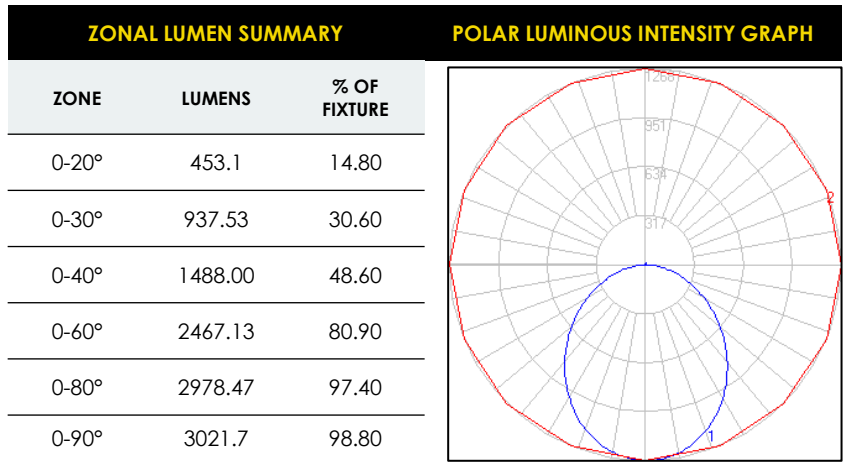

AE-SF-F2-8-61-30/35/40-BK
 8 FEET
 61 WATTS

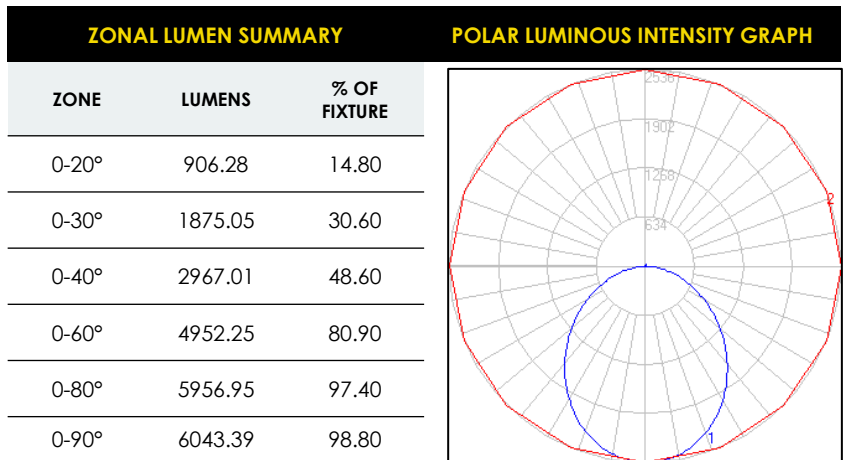

DATE				
PROJECT NAME				
TYPE				
QTY				
ORDERING CODE	AE-SF-F2-			30/40/CCT-

OVERVIEW

COLOR SELECTABLE

CCT switch to change between 3 CCT – 3000K, 3500K and 4000K – variations from warm to cool light on field.

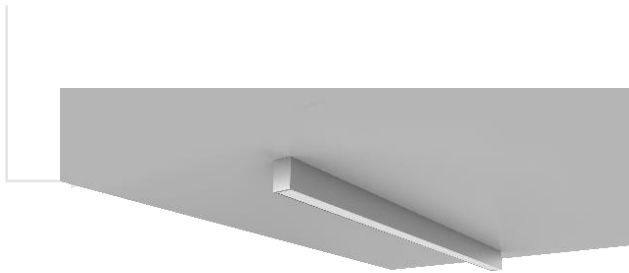
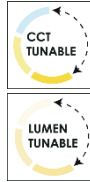

CONTINUOUS RUNS

Easily connect multiple fixtures together for continuous mounting configuration with the help of our simple link kits .

MOUNTING

Easy linkable surface mounted fixtures to allow creative designs on the ceiling.

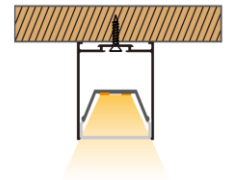
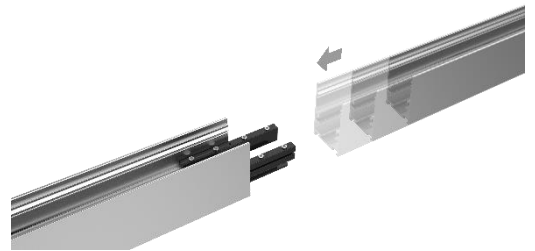

FINISHES

Standard ERALUX finish in black, white and silver options to provide an elegant look to the fixture's housing.

DATE				
PROJECT NAME				
TYPE				
QTY				
ORDERING CODE	AE-SF-F2-			30/40/CCT-

Draw your custom shape! 1 square = 1ft

