

## OUTDOOR LED LIGHT

### Adjustable Wall Pack | Power & CCT Switchable

The Fogo adjustable wall packs are high-efficiency luminaires featuring a die-cast aluminum shell with a machined finish. With an adjustable head, the beam can be directed in multiple positions to suit various needs. The fixture is both power- and CCT-switchable, with an input voltage range of 120 to 347V, making it adaptable for a wide range of projects and applications.

Applications: Building contour | parking spaces | Alleyway | Garage door

	DATE	QTY	ACC. QTY	TYPE
PROJECT				
PN				
ACCESSORY PN				
NOTES				



#### DYNAMIC MENU

Order Information	<a href="#">Page 2</a>
Dimensions	<a href="#">Page 3</a>
Accessories	<a href="#">Page 4</a>
Photometric Data	<a href="#">Page 5</a>

[Install Instruction link](#)

#### SPECIFICATIONS

Input Voltage	120-347V
Power Factor	>0.9
Total Harmonic Distortion	<20%
Dimming	0-10V dimming
CRI	80 CRI
CCT	<div style="display: flex; gap: 10px;"> <div style="border: 1px solid black; border-radius: 50%; width: 20px; height: 20px; background-color: #fff9c4; display: flex; align-items: center; justify-content: center;">30K</div> <div style="border: 1px solid black; border-radius: 50%; width: 20px; height: 20px; background-color: #fff9c4; display: flex; align-items: center; justify-content: center;">40K</div> <div style="border: 1px solid black; border-radius: 50%; width: 20px; height: 20px; background-color: #fff9c4; display: flex; align-items: center; justify-content: center;">50K</div> </div>
Efficacy	~120 lm/W
Power	10/15/25W 45/60/70W
Ambient Temperature Range	-40°C to 70°C
Mounting Options	Wall Mount
Fixture Finish	Black   White   Bronze <div style="display: flex; gap: 10px;"> <div style="width: 20px; height: 20px; background-color: black; border-radius: 50%;"></div> <div style="width: 20px; height: 20px; background-color: white; border-radius: 50%;"></div> <div style="width: 20px; height: 20px; background-color: #808080; border-radius: 50%;"></div> </div>
Controls	Photocell Emergency Battery Back up
Protection	IP65; water and dust resistance IK08; impact resistance
Distribution	65° X 95°
Lens	Polycarbonate Lens



#### PRODUCT FEATURES



#### PRODUCT CERTIFICATIONS



Design Lights Consortium® (DLC) qualified product. Not all versions of this product may be DLC qualified. Please check the DLC Qualified Products List at [www.designlights.org/QPL](http://www.designlights.org/QPL) to confirm which versions are qualified" [page 2](#)

#### SYSTEM WARRANTY – 5 YEARS

Eralux will warrant defective drivers, LEDs and boards for 5 years from the date of purchase. This warranty is valid only if the fixture is installed and used as per installation guides and specifications. If a defect is present, Eralux will send drivers and boards at no fee with a thorough replacement instructions along with instructions on the return of the defective parts back to Eralux.

#### LUMEN MAINTENANCE – L70 at 50,000 hours

Rated for 70% initial lumen output at 50,000 hours of operation, operated at 25°C ambient temperature; per guidelines published by the Illuminating Engineering Society (IES).

## OUTDOOR LED LIGHT

Adjustable Wall Pack | Power & CCT Switchable



### ORDERING GUIDE

<b>AE-WP-FG-</b>		<b>-TCP</b>	<b>-CA</b>		
<b>AE-WP-FG-</b> ERALUX FOGO Outdoor Wall pack Light	<b>25W</b> 25W/20W/15W 3,000/2,400/1,800 lm <b>75W</b> 75W/60W/45W 9,000/7,200/5,400 lm	<b>-TCP</b> Selectable 30/40/50K	<b>-CA</b> 120-347 vac	<b>-D</b> 0-10V Dimming <b>-P</b> Photocell <b>-EM</b> Emergency Battery	<b>-BK</b> Black <b>-BZ</b> Bronze <b>-WH</b> White
<b>Fixture Family</b>	<b>Power</b>	<b>CCT</b>	<b>Input Voltage</b>	<b>CCT</b>	<b>Finish</b>

### NOTES

Emergency Battery backup 15W output  
Exterior junction box is supplied with the Emergency Battery Back Up

### DIMENSIONS

#### AE-WP-FG-XXW-TCP-CA-X-XX

**25W**

**75W**

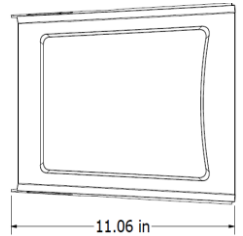
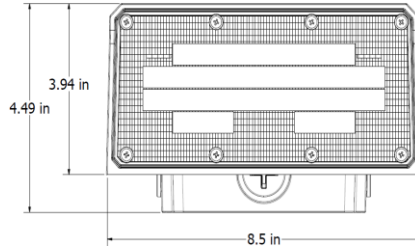
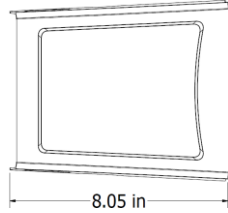
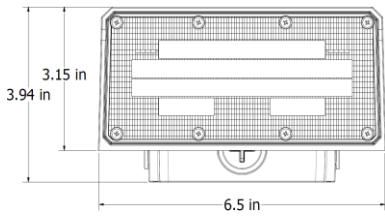

### Back Plate Installation

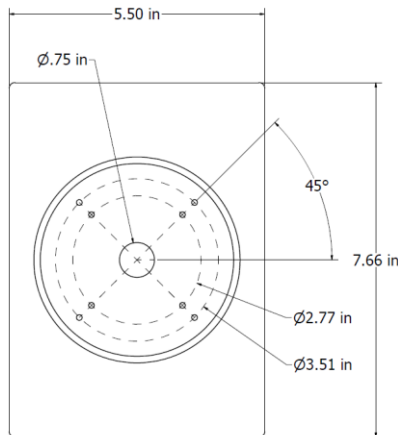

## OUTDOOR LED LIGHT

Adjustable Wall Pack | Power & CCT Switchable

### CONTROLS

#### EMERGENCY LED DRIVER

BLD-HM15D-YYY



SPECIFICATION	
Input Voltage	100-347Vac
Power Frequency	50/60HZ
Output Voltage	170V DC
Ambient Temperature	0°C to 50°C
	30°F to 122°F
Output Power	15W
Installation	Remote with exterior junction Box

The BLD-HMXXD-YYY series LED Emergency Driver is UL listed for field and factory installations. It switches to emergency mode during power failures, providing up to 90 minutes of lighting. With an integrated battery, charger, and converter, it delivers 6-25W constant power at 170VDC. Ideal for 0-10V dimmable indoor commercial LED fixtures, such as flat panels, troffers, downlights, and linear strip lights.



#### NOTES

The exterior junction box is wall mounted close to the fixture

#### DIMENSIONS

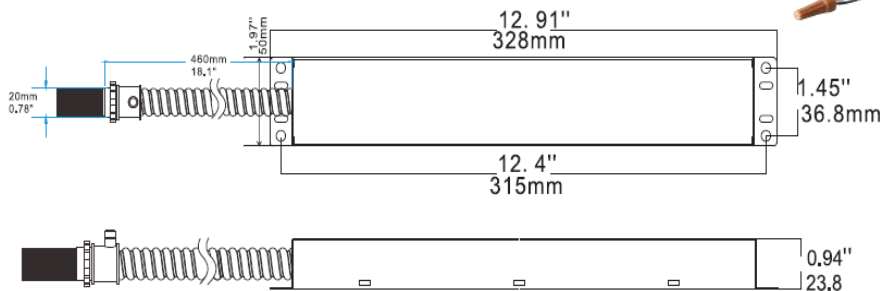

## OUTDOOR LED LIGHT

Adjustable Wall Pack | Power & CCT Switchable

### PHOTOMETRIC DATA

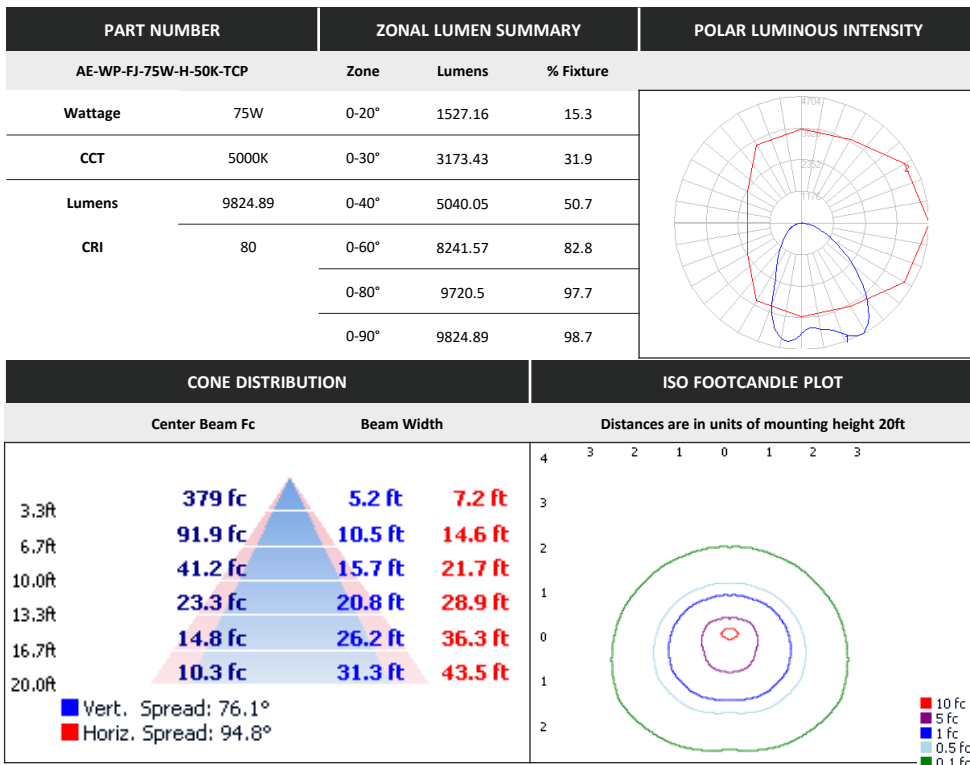
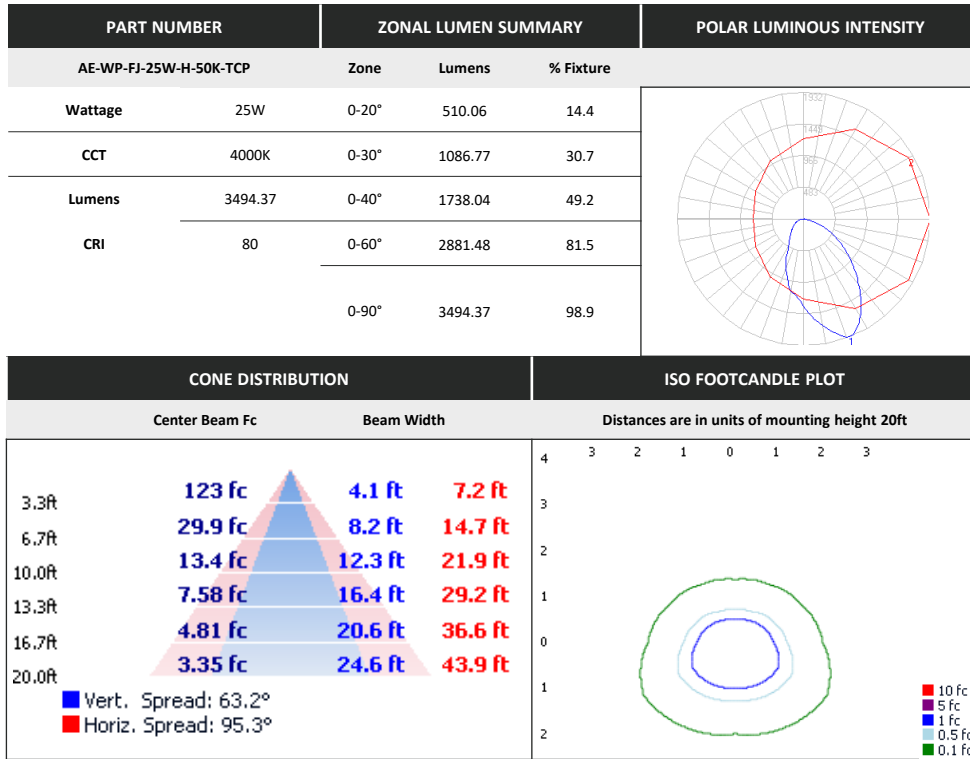

## OUTDOOR LED LIGHT

Adjustable Wall Pack | Power & CCT Switchable

### OVERVIEW



#### Innovative Design

- Aluminum die-cast for superior heat management, enhanced waterproofing to withstand harsh weather conditions
- Easy to Adjust Lamp head allows you to manipulate the lamp head from 0 to 90 degrees



#### Protection



- Protected against dust ingress.
- Protected against water jets
- Impact resistant



#### Accessories

- 120-347V photocell
- Integrated Emergency Battery Back up



#### Multiple Options

- CCT Switchable ; 30/40/50K
- Black, white & bronze finish
- Power Switchable ; 15/20/25W or 45/60/75W



#### Tests And Certifications



#### Adjustable

- Tilting angle ranges between 0-90°

DLC MODEL	PRODUCT ID
AE-WP-FG-75W-TCP-CA-[D,P]-[Blank, BZ,BK,WH]	S-LWCZFF
AE-WP-FG-25W-TCP-CA-[D,P]-[Blank, BZ,BK,WH]	S-NCFHL7

