

GRETA

OUTDOOR PRODUCTS

Outdoor Canopy Light



The GRETA Series outdoor luminaire is a parking garage fixture that enables customization on site with the CCT and lumens switchable capability. Its robust and durable design allow it to withstand the outdoor elements wherever placed. Further, the GRETA series comes standard in 120-277Vac, ready for surface mount, pole mount and even enable surface connection of EMTs.

eralux®



DATE			
PROJECT NAME			
TYPE			
QTY			
ORDERING CODE	AE-OD-GR	-	-30K/40K/50K-G-TCP-CA -

OPERATING & ELECTRICAL

INPUT VOLTAGE	120-347Vac
POWER FACTOR	0.9
TOTAL HARMONIC DISTORTION (THD)	<20%
DIMMING	0-10V dimming

PERFORMANCE

LUMENS PER WATT	~135 lm/W
POWER SWITCHABLE	28/35/40W 40/60/70W
CCT SWITCHABLE	3000K/4000K/5000K
BEAM ANGLE	155°

MECHANICAL & HOUSING

HOUSING	Aluminum die cast housing for superior heat dissipation, strength, and rigidity.
LENS	UV resistant, polycarbonate lens ensures high efficiency light output for a clean, evenly illuminated surface with minimal glare. High transmittance lens allowing for a smooth, diffused light pattern.
FINISH	Powder coat finish for the toughest outdoor conditions. Available in white color.
POWER SUPPLY	Factory wired electronic LED driver
LED BOARD	LED Array

APPLICATION CONDITION

AMBIENT TEMPERATURE RANGE	-40°C to 40°C
PROTECTION	LED fixture IP65 rated

COMPATIBLE MOUNTING

MOUNTING	Surface, 3/4" NPT pole mount
----------	------------------------------

WARRANTY

SYSTEM WARRANTY – 5 YEARS

Eralux will warrant defective drivers, LEDs and boards for 5 years from the date of purchase. This warranty is valid only if the fixture is installed and used as per installation guides and specifications. If a defect is present, Eralux will send drivers and boards at no fee with a thorough replacement instructions along with instructions on the return of the defective parts back to Eralux.

LUMEN MAINTENANCE – L70 at 100,000 hours

Rated for 70% initial lumen output at 100,000 hours of operation, operated at 25°C ambient temperature; per guidelines published by the Illuminating Engineering Society (IES). (L70 at 100,000 hours)



"DesignLights Consortium® (DLC) qualified product. Not all versions of this product may be DLC qualified. Please check the DLC Qualified Products List at www.designlights.org/QPL to confirm which versions are qualified"

DATE					
PROJECT NAME					
TYPE					
QTY					
ORDERING CODE	AE-OD-GR	-	-30K/40K/50K-G-TCP-CA		

ORDERING GUIDE

EXAMPLE: AE-OD-GR-70W-30K/40K/50K/-G-TCP-CA

FIXTURE FAMILY	POWER	CCT	TUNABLE	VOLTAGE	CONTROL
AE-OD-GR	-	-30K/40K/50K	-G-TCP	-CA	-
AE-OD-GR ERALUX GRETA outdoor canopy light fixture	- 40W Switchable 28/35/40W 3360lms/4200lms/5400lms	-30K/40K/50K Switchable 3000K/4000K/5000K CCT	-G-TCP Tunable CCT and Power	-CA 120-347V	[LEAVE BLANK]
	- 70W Switchable 40/60/70W 5400lms/7200lms/8400lms				- MS* Motion Sensor 120-277V
					-P Photocell

* Motion sensor input voltage is 120-277V

PRODUCT DIMENSIONS

AE-OD-GR-40W/AE-OD-GR-70W

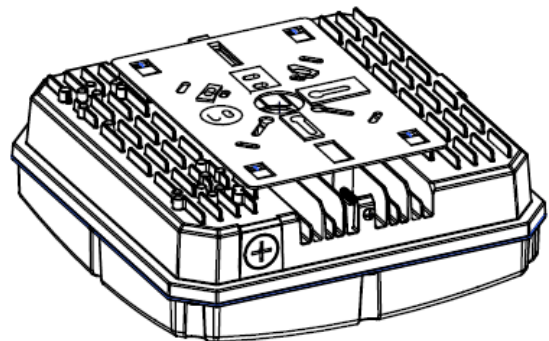
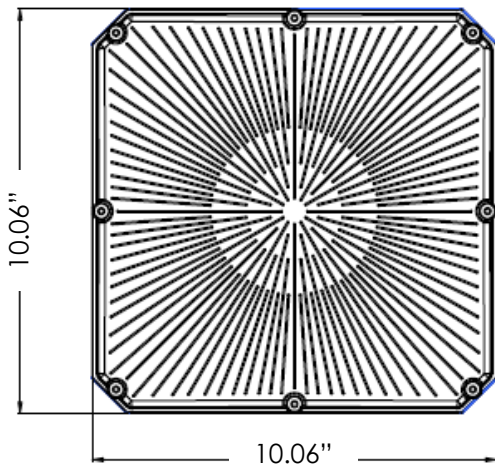
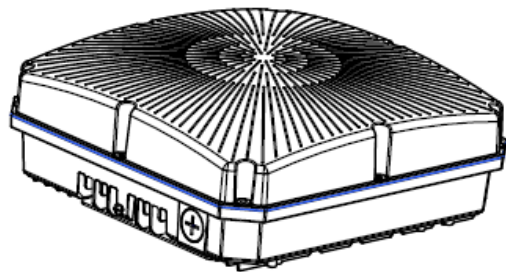
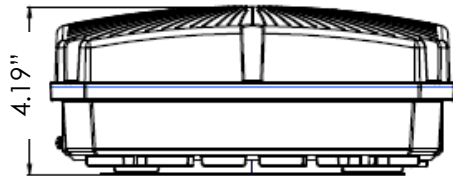

DATE			
PROJECT NAME			
TYPE			
QTY			
ORDERING CODE	AE-OD-GR	-	-30K/40K/50K-G-TCP-CA

ACCESSORIES

Ordered separately, field installed

EMERGENCY LED DRIVER (BLD-HMXXD-YYY)

EMQ- 8300DO- HY

OUTPUT POWER : 8 WATTS

SPECIFICATION	
INPUT VOLTAGE	100-347Vac
INPUT CURRENT	100mA max
RECHARGE TIME	24Hrs
DISCHARGE TIME	1.5H
EMERGENCY POWER	8W



Introducing a UL-listed emergency lighting solution for the US and Canada, featuring high output voltage, self-testing, and overcharge/discharge protection. Compliant with UL924 and CSA C22.2 NO.141, it's suitable for field or factory installation and integrates seamlessly with LED drivers. With low energy consumption and Title20 compliance, it offers 8W emergency power options, a quick 24-hour recharge time, and 1.5-hour discharge time.

DRIVER DIMENSIONS

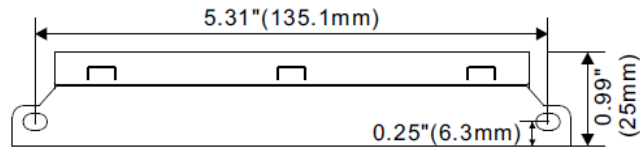
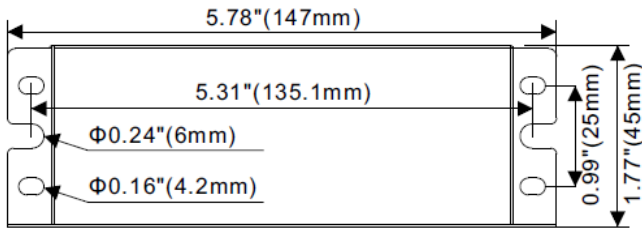

BATTERY DIMENSIONS

8W VERSION

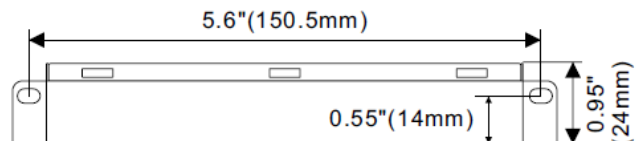
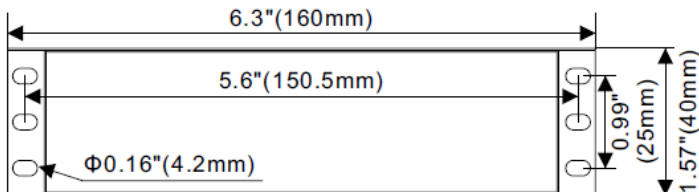

DATE				
PROJECT NAME				
TYPE				
QTY				
ORDERING CODE	AE-OD-GR	-	-30K/40K/50K-G-TCP-CA	-

ACCESSORIES (Continued)

ACCESSORIES	ORDERING CODE
REMOTE CONTROL	AE-OD-GR-RMT
MOTION SENSOR	AE-OD-GR-MOTIONSENSOR

Motion Sensor



Parameter	
Input voltage	120/277V
Working mode	On/Off function 1-10V step dimming
Operating temperature	-25C - +60C
Mounting height	12m Max
Factory setting	<ul style="list-style-type: none"> Detection area: 100 Hold Time: 5S Stand-by Period: 0S Stand-by dim level:10% Daylight Sensor: Disable

Sensor parameter	
Hold time	5S/30S/1min/3min/20min/30min 5s/30s/1min/3min/5min/10min/20min/30min(remote control)
Stand-by DIM Level	10%/20%/50% (Only DIP Switch)
Stand-by Period	0S/5S/5min/10min/30min/1h/+∞ 0s/10s/1min/3min/5min/10min/30min/+∞ (Remote control)
Detection Area	100%/75%/50%/10% 100%/75%/50%/25% (Remote control)
Daylight Sensor	5Lux/15Lux/30Lux/50Lux/100Lux/150Lux/Disable (Ambient light diffusion) 5lux/15lux/30lux/50lux/100lux/150lux/Disable (Remote control)

DATE				
PROJECT NAME				
TYPE				
QTY				
ORDERING CODE	AE-OD-GR	-	-30K/40K/50K-G-TCP-CA	-

LUMEN ESTIMATE

Lumen output varies based on CCT and CRI. An estimate of lumen output of the various CCT/CRI combinations, use correction factors as per table below:

LUMEN ESTIMATE ADJUSTMENT FACTORS			
CCT	3000K	4000K	5000K
NORMAL (80CRI)	0.94	0.97	1

DLC MODELS

PRODUCT ID	DLC MODEL
S-NDO6T0	AE-OD-GR-70W-30K/40K/50K-G-TCP-CA-[Blank;(PC),(BT),(BTP)]
S-0NV9M8	AE-OD-GR-40W-30K/40K/50K-G-TCP-CA-[Blank;(PC),(BT),(BTP)]

PHOTOMETRIC DATA

AE-OD-GR-40W/60W/70W-
30K/40K/50K-G-TCP-CA 70W @
3000K

LUMINOUS INTENSITY DISTRIBUTION DIAGRAM

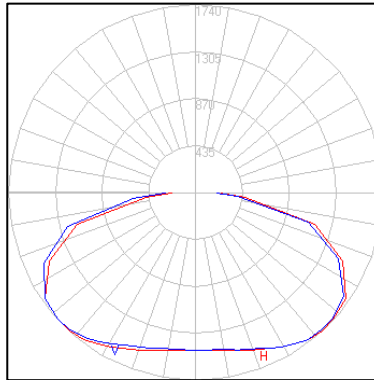

C0 PLANE ISOLUX DIAGRAM (UNIT:lx)

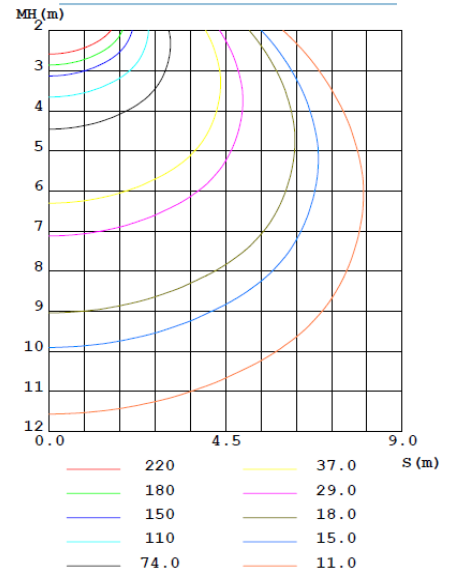

DATE				
PROJECT NAME				
TYPE				
QTY				
ORDERING CODE	AE-OD-GR	-	-30K/40K/50K-G-TCP-CA	-

OVERVIEW



MOUNTING

Mount using 3/4" NPT pole or fix flush by surface mounting to wall or ceiling of your project space.

BATWING DISTRIBUTION

155-degree bat-wing beam angle provides a unique distribution while accenting your project space.

ON-SITE FLEXIBILITY

Choose from three of the CCT and three of the power package. A 9-in-1 fixture!

CANADA READY

Comes standard with an operating voltage of 120-347V AC

