

ALPS EVOLVE SERIES

RECESSED COMMERCIAL LUMINAIRES

Flat Panel

The ALPS series is a backlit panel product designed with optimum LED placement to ensure a uniformly lit diffuser. It features a switchable CCT, and power package enable an endless flexibility at the install site. The average 130LPW performance also makes the ALPs an ideal replacement for any existing recessed commercial ceiling products.

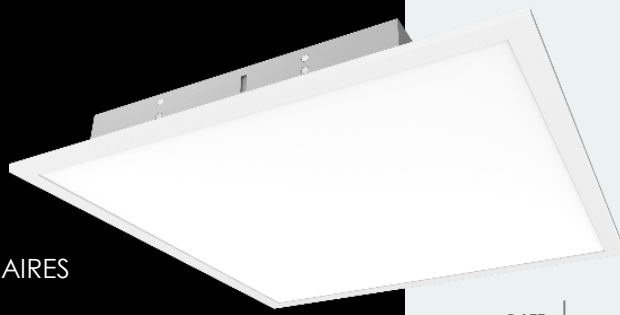

eralux®



| | |
|---------------|-----------------|
| DATE | |
| PROJECT NAME | |
| TYPE | |
| QTY | |
| ORDERING CODE | AE-RC-APB-XXW - |

OPERATING & ELECTRICAL

| | |
|---------------------------------|---------------------|
| INPUT VOLTAGE | 120-277V / 120-347V |
| POWER FACTOR | 0.9 |
| DIMMING | 0-10V |
| TOTAL HARMONIC DISTORTION (THD) | <20% |

PERFORMANCE

| | |
|-----------------|------------------|
| LUMENS PER WATT | 125 LPW at 80CRI |
| POWER | 20 to 50 W |
| CCT | 35/40/50K |
| BEAM ANGLE | Lambertian |

MECHANICAL & HOUSING

| | |
|--------------|--|
| HOUSING | Aluminum frame |
| LENS | Enhanced quality diffuser ensures high efficiency light output for a clean, evenly illuminated surface |
| FINISH | White |
| POWER SUPPLY | Factory wired electronic LED driver |
| LED BOARD | LED array |

APPLICATION CONDITION

| | |
|---------------------------|----------------|
| AMBIENT TEMPERATURE RANGE | -20 °C to 45°C |
| PROTECTION | Dry rated |

COMPATIBLE MOUNTING

| | |
|----------|-----------------------------|
| MOUNTING | DX, DXT Grid, surface mount |
|----------|-----------------------------|

WARRANTY

SYSTEM WARRANTY – 5 YEARS

Eralux will warrant defective drivers, LEDs and boards for 5 years from the date of purchase. This warranty is valid only if the fixture is installed and used as per installation guides and specifications. If a defect is present, Eralux will send drivers and boards at no fee with a thorough replacement instructions along with instructions on the return of the defective parts back to Eralux.

LUMEN MAINTENANCE – L70 at 50,000 hours

Rated for 70% initial lumen output at 50,000 hours of operation, operated at 25°C ambient temperature; per guidelines published by the Illuminating Engineering Society (IES).

ALPS EVOLVE SERIES

RECESSED COMMERCIAL LUMINAIRES

Flat Panel

| | |
|---------------|-------------------|
| DATE | |
| PROJECT NAME | |
| TYPE | |
| QTY | |
| ORDERING CODE | AE-RC-APB-XXW - - |

ORDERING GUIDE

EXAMPLE: AE-RC-APB-XXW24-28CDMH-01

| FIXTURE FAMILY | POWER | SIZE | CONTROLS | INPUT VOLTAGE |
|--|--|--|---|---------------------------|
| AE-RC-APB | -XXW | | - | |
| AE-RC-APB ALPS Evolve series commercial office backlit panel | -XXW 2x4: 30-40-50W 2x2: 25-30-35W 1x4: 25-30-35W CCT Selectable: 3500/4000/5000K | 22 2'x2' housing 3,125-3,750-4,375 lumens | -28CDM 0-10V external dimming down to 10% | H-02 120-347Vac |
| | | 24 2'x4' housing 4,375-5,000-5,625-6,250 lumens | -28CDS Microwave Motion Sensor *ONLY for 120-277V* | L-01 120-277Vac |
| | | 14 1'x4' housing 3,125-3,750-4,375 lumens | | |

PRODUCT DIMENSIONS

2x2

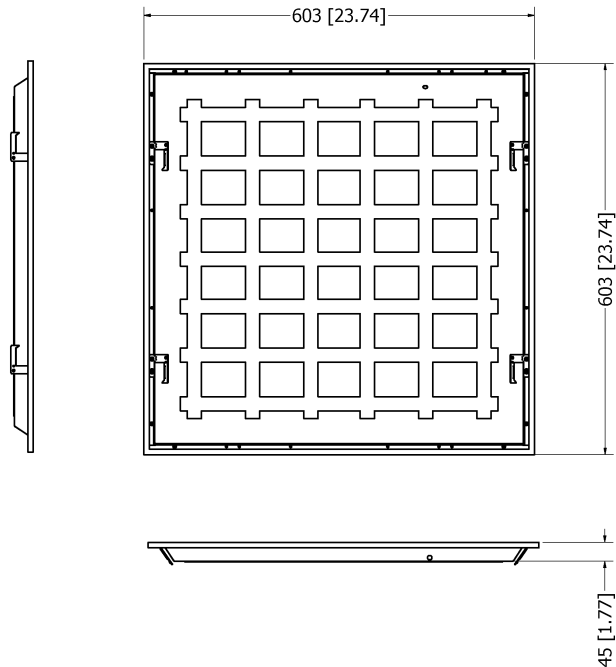

ALPS EVOLVE SERIES

RECESSED COMMERCIAL LUMINAIRES

Flat Panel

| | | | |
|---------------|---------------|---|--|
| DATE | | | |
| PROJECT NAME | | | |
| TYPE | | | |
| QTY | | | |
| ORDERING CODE | AE-RC-APB-XXW | - | |

PRODUCT DIMENSIONS

1x4

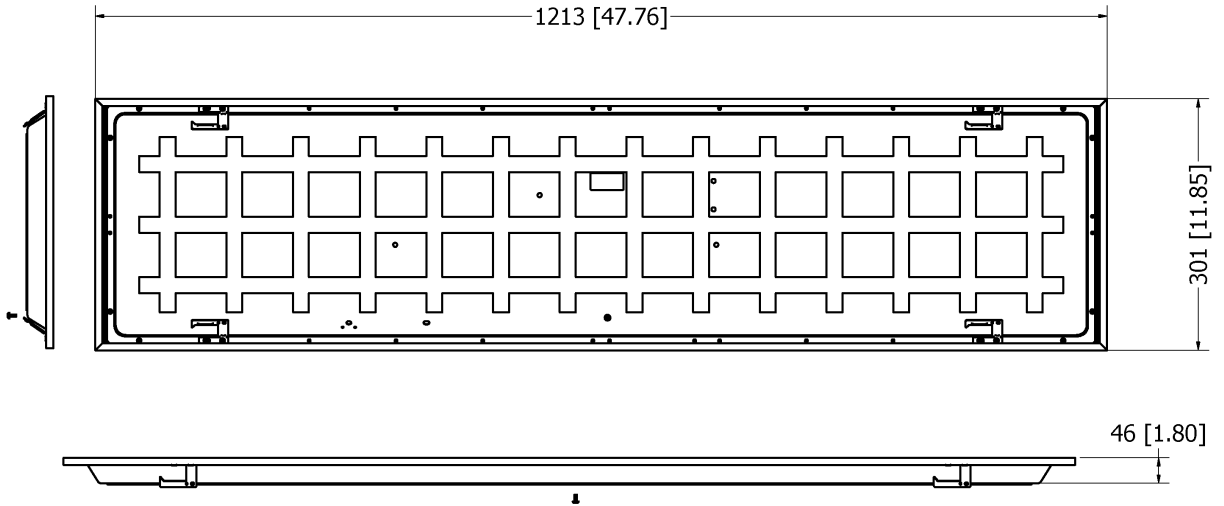

2x4

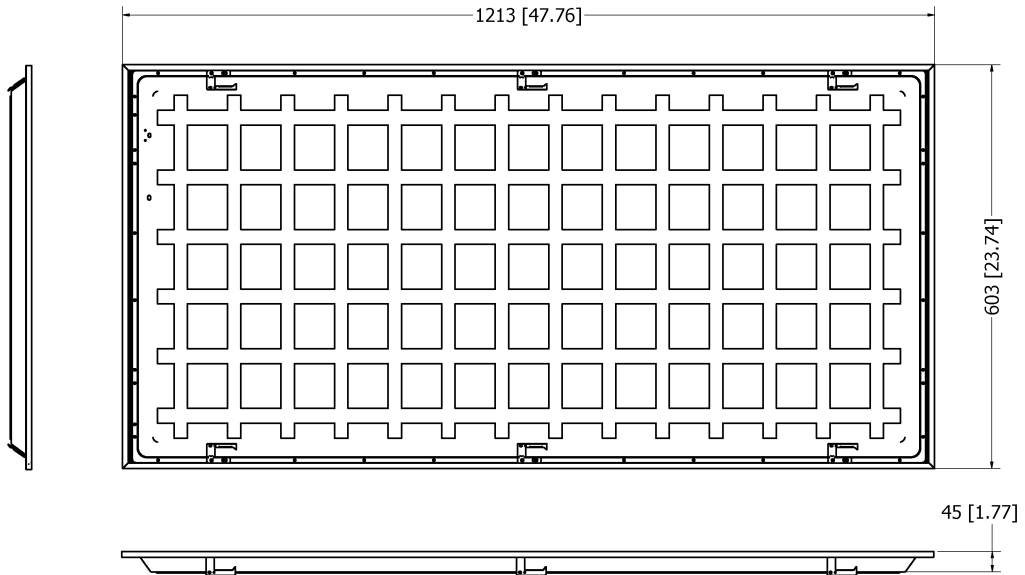

ALPS EVOLVE SERIES

RECESSED COMMERCIAL LUMINAIRES

Flat Panel

| | | | |
|---------------|---------------|--|---|
| DATE | | | |
| PROJECT NAME | | | |
| TYPE | | | |
| QTY | | | |
| ORDERING CODE | AE-RC-APB-XXW | | - |

ACCESSORIES

Ordered separately, field installed

GYP SUM KIT

Recessed Gypsum



DIMENSIONS

| LENGTH | LENGTH | WIDTH | HEIGHT |
|--------|------------------|-----------------|--------------|
| 2 X 4 | 1247 mm 49.1" | 638 mm 25.1" | 38mm 1.5" |
| 2 X 2 | 638 mm 25.1" | 638 mm 25.1" | 38mm 1.5" |
| 1 X 4 | 1247 mm 49.1" | 338 mm 13.3" | 38mm 1.5" |

ORDERING CODE

AE-RC-MBGYPK1X4

AE-RC-MBGYPK2X2

AE-RC-MBGYPK2X4

SURFACE MOUNT KIT

DX,DXT GRID, Surface Mount

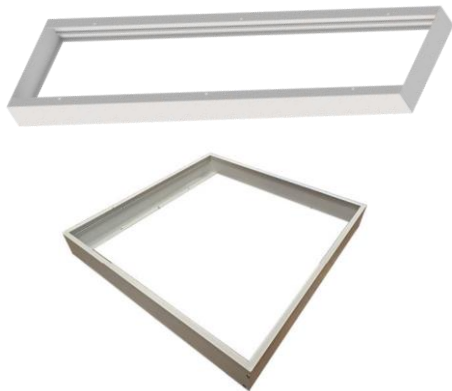

DIMENSIONS

| LENGTH | LENGTH | WIDTH | HEIGHT |
|--------|----------------|-----------------|-------------|
| 2 X 4 | 1219 mm 48" | 609 mm 24" | 50 mm 2" |
| 2 X 2 | 609 mm 24" | 609mm 24" | 50mm 2" |
| 1 X 4 | 1219 mm 48" | 309 mm 12.2" | 50 mm 2" |

ORDERING CODE

AE-RC-MBSMK14

AE-RC-MBSMK22

AE-RC-MBSMK24

HANGING KIT



ORDERING CODE

AE-RC-MB-HK

ALPS EVOLVE SERIES

RECESSED COMMERCIAL LUMINAIRES

Flat Panel

| | | | |
|---------------|---------------|---|--|
| DATE | | | |
| PROJECT NAME | | | |
| TYPE | | | |
| QTY | | | |
| ORDERING CODE | AE-RC-APB-XXW | - | |

ACCESSORIES (Continued)

Ordered separately, field installed

EMERGENCY LED DRIVER (BLD-HMXXD-YYY)

BLD-HM8D-YYY

OUTPUT POWER : 8 WATTS

BLD-HM25D-YYY

OUTPUT POWER : 25 WATTS



BLD-HMXXD-YYY series LED Emergency Driver is UL listed for field and factory installation that allows the same LED fixture to be used for both normal and emergency operation . In the event of a power failure , the emergency driver switches to emergency mode and operates the existing. Fixture to 90 minutes. The unit contains a battery , charge , and converter circuit in a single enclosure .This module will operate an LED array load at 6-25W with constant power at a rated output voltage of 170VDC. The constant power design of BLD-HMXXD-YYY maintains the output wattage to LED array, providing consistent illumination for entire emergency runtime. Ideal for use with most 0-10V dimmable indoor commercial LED lighting fixtures, such as LED flat panel, troffer, downlight and suspension mounting LED linear strip lights, etc.

DIMENSIONS (inches and mm)

Single Flex

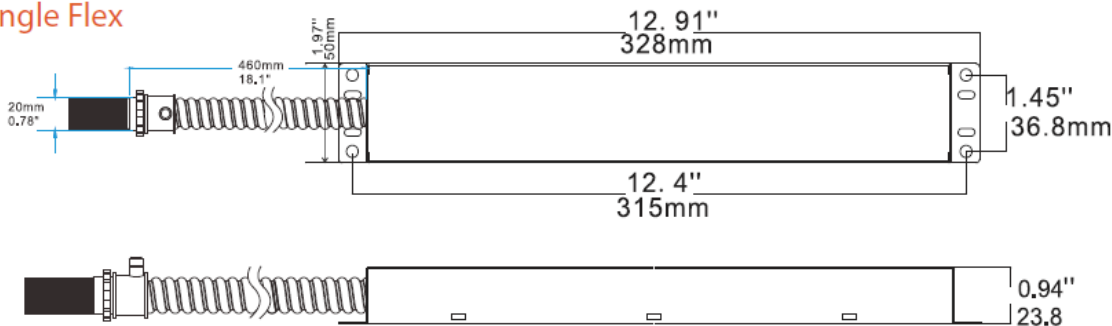

ALPS EVOLVE SERIES

RECESSED COMMERCIAL LUMINAIRES

Flat Panel

| | | | |
|---------------|---------------|--|---|
| DATE | | | |
| PROJECT NAME | | | |
| TYPE | | | |
| QTY | | | |
| ORDERING CODE | AE-RC-APB-XXW | | - |

LUMEN ESTIMATE

Lumen output varies based on CCT and CRI. An estimate of lumen output of the various CCT/CRI combinations, use correction factors as per table below:

| LUMEN ESTIMATE ADJUSTMENT FACTORS | | | | |
|-----------------------------------|-------|-------|-------|-------|
| CCT | 3000K | 3500K | 4000K | 5000K |
| PREMIUM (80CRI) | 0.94 | 0.97 | 1 | 1.03 |

PHOTOMETRIC DATA

AE-RC-APB-35W22-28CDMH-01 (3000K)

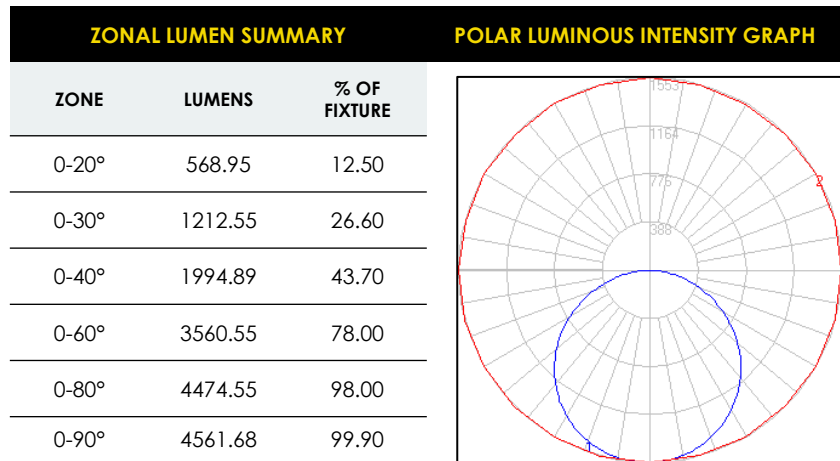

AE-RC-APB-40W24-28CDMH-01 (5000K)

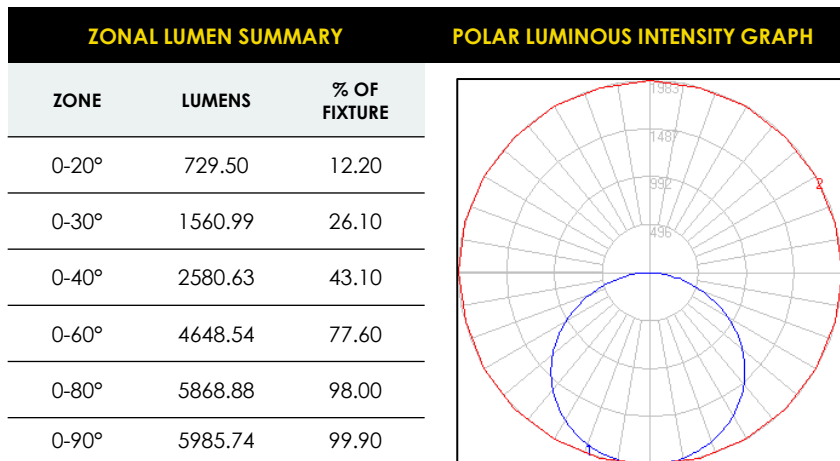

ALPS EVOLVE SERIES

RECESSED COMMERCIAL LUMINAIRES

Flat Panel

| | | | | |
|---------------|---------------|--|---|--|
| DATE | | | | |
| PROJECT NAME | | | | |
| TYPE | | | | |
| QTY | | | | |
| ORDERING CODE | AE-RC-APB-XXW | | - | |

DLC MODELS

| DLC MODEL | PRODUCT ID |
|---|------------|
| AE-RC-APB-20W14-28[RDM,RDS,RDE,RSE,CDM,CDS,CDE,CSE][L,H]-01 | S-5ELXM9 |
| AE-RC-APB-20W22-28[RDM,RDS,RDE,RSE,CDM,CDS,CDE,CSE][L,H]-01 | S-UFCYPQ |
| AE-RC-APB-25W14-28[CDM,CDS,CDE,CSE][L,H]-02 | S-XG2TN7 |
| AE-RC-APB-25W14-28[RDM,RDS,RDE,RSE,CDM,CDS,CDE,CSE][L,H]-01 | S-9TOLAY |
| AE-RC-APB-25W22-28[CDM,CDS,CDE,CSE][L,H]-02 | S-I06RL3 |
| AE-RC-APB-25W22-28[DDM,DDS,DDE,DSE][L,H]-013000K | S-Q4XGVS |
| AE-RC-APB-25W22-28[DDM,DDS,DDE,DSE][L,H]-013500K | S-1WCFKE |
| AE-RC-APB-25W22-28[DDM,DDS,DDE,DSE][L,H]-014000K | S-BCJ30R |
| AE-RC-APB-25W22-28[DDM,DDS,DDE,DSE][L,H]-015000K | S-ZU2P1Y |
| AE-RC-APB-25W22-28[RDM,RDS,RDE,RSE,CDM,CDS,CDE,CSE][L,H]-01 | S-NA173X |
| AE-RC-APB-30W14-28[CDM,CDS,CDE,CSE][L,H]-02 | S-QGPMSO |
| AE-RC-APB-30W14-28[RDM,RDS,RDE,RSE,CDM,CDS,CDE,CSE][L,H]-01 | S-ML7IXT |
| AE-RC-APB-30W22-28[CDM,CDS,CDE,CSE][L,H]-02 | S-UKSVL4 |
| AE-RC-APB-30W22-28[RDM,RDS,RDE,RSE,CDM,CDS,CDE,CSE][L,H]-01 | S-OA21HW |
| AE-RC-APB-30W24-28[CDM,CDS,CDE,CSE][L,H]-02 | S-TOVI16 |
| AE-RC-APB-35W14-28[CDM,CDS,CDE,CSE][L,H]-02 | S-IWZN5H |
| AE-RC-APB-35W14-28[RDM,RDS,RDE,RSE,CDM,CDE,CSE][L,H]-01 | S-9FO1XG |
| AE-RC-APB-35W22-28[CDM,CDS,CDE,CSE][L,H]-02 | S-CLT4PE |
| AE-RC-APB-35W22-28[RDM,RDS,RDE,RSE,CDM,CDE,CSE][L,H]-01 | S-GZBDWS |
| AE-RC-APB-35W24-28[RDM,RDS,RDE,RSE,CDM,CDE,CSE][L,H]-01 | S-D2YEFN |
| AE-RC-APB-36W14-28[RDM,RDS,RDE,RSE,CDM,CDS,CDE,CSE][L,H]-01 | S-HWDTKJ |
| AE-RC-APB-40W24-28[CDM,CDS,CDE,CSE][L,H]-02 | S-QIA1FD |
| AE-RC-APB-40W24-28[RDM,RDS,RDE,RSE,CDM,CDE,CSE][L,H]-01 | S-1RDUFG |
| AE-RC-APB-45W24-28[RDM,RDS,RDE,RSE,CDM,CDE,CSE][L,H]-01 | S-LQKW75 |
| AE-RC-APB-50W24-28[CDM,CDS,CDE,CSE][L,H]-02 | S-G7TPZE |
| AE-RC-APB-50W24-28[RDM,RDS,RDE,RSE,CDM,CDE,CSE][L,H]-01 | S-Y72LOO |

ALPS EVOLVE SERIES

RECESSED COMMERCIAL LUMINAIRES

Flat Panel

| | | | |
|---------------|---------------|---|--|
| DATE | | | |
| PROJECT NAME | | | |
| TYPE | | | |
| QTY | | | |
| ORDERING CODE | AE-RC-APB-XXW | - | |

OVERVIEW



VOLTAGE RATING

Multiple input voltage ratings, 120-277Vac or 120-347Vac, perfect for both American and Canadian Markets.

MULTIPLE PACKAGES

Select from the standard 0-10V dimming model or add the additional 90-minute emergency battery back-up kit.

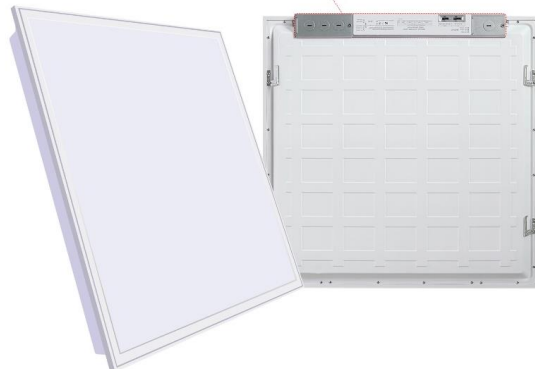
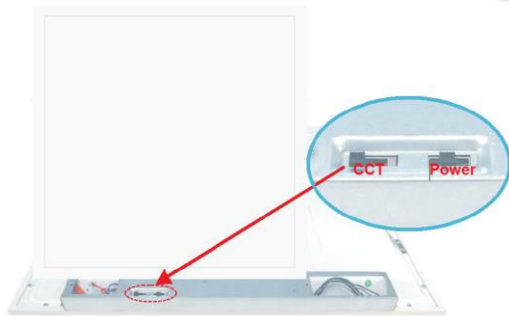

THIN PROFILE

Ultra-thin housing with polystyrene reflector enable the 2nd generation Alps fixture to be extremely lightweight while providing an elegant appearance.

