

ALPS E2

Commercial LED Lighting

Back-Lit Panel | 1x4

The ALPS E2 series is a backlit flat panel that offers uniform lighting. With switchable CCT and switchable power options, it provides unmatched flexibility for any installation. Delivering an impressive 125 LPW, the ALPS is the ideal energy-efficient upgrade for existing recessed commercial ceiling applications. Applications: Commercial Office Spaces | Healthcare | Schools | Retail Merchandising Areas.



	DATE	QTY	ACC. QTY	TYPE
PROJECT				
PN				
ACCESSORY PN				
NOTES				



DYNAMIC MENU

Ordering Guide	Page 2
Dimensions	Page 3
Control	Page 5
Photometric Data	Page 6

[Install Instructions](#)

SPECIFICATIONS

Input Voltage	120-277V 120-277/347V	
Power Factor	>0.9	
Total Harmonic Distortion	<20%	
Dimming	0-10V Dimming	
CRI	80 CRI	
CCT	<div style="display: flex; gap: 10px;"> <div style="border: 1px solid black; border-radius: 50%; width: 20px; height: 20px; background-color: #fff9c4; display: flex; align-items: center; justify-content: center;">30K</div> <div style="border: 1px solid black; border-radius: 50%; width: 20px; height: 20px; background-color: #e0e0e0; display: flex; align-items: center; justify-content: center;">35K</div> <div style="border: 1px solid black; border-radius: 50%; width: 20px; height: 20px; background-color: #e0e0e0; display: flex; align-items: center; justify-content: center;">40K</div> <div style="border: 1px solid black; border-radius: 50%; width: 20px; height: 20px; background-color: #e0e0e0; display: flex; align-items: center; justify-content: center;">50K</div> </div>	
Efficacy	~125LPW	
Power	1x4	25/30/35W
Ambient Temperature Range	-20°C to 45°C	
Distribution	120°	
Mounting options <small>page 4</small>	Surface Mount Suspended Recessed- Gypsum Recessed -T grid	



PRODUCT FEATURES



PRODUCT CERTIFICATIONS



Design Lights Consortium® (DLC) qualified product. Not all versions of this product may be DLC qualified. Please check the DLC Qualified Products List at www.designlights.org/QPL to confirm which versions are qualified" [page 7](#)

SYSTEM WARRANTY – 5 YEARS

Eralux will warrant defective drivers, LEDs and boards for 5 years from the date of purchase. This warranty is valid only if the fixture is installed and used as per installation guides and specifications. If a defect is present, Eralux will send drivers and boards at no fee with a thorough replacement instructions along with instructions on the return of the defective parts back to Eralux.

LUMEN MAINTENANCE – L70 at 50,000 hours

Rated for 70% initial lumen output at 50,000 hours of operation, operated at 25°C ambient temperature; per guidelines published by the Illuminating Engineering Society (IES).



ORDERING GUIDE

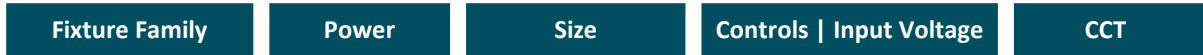
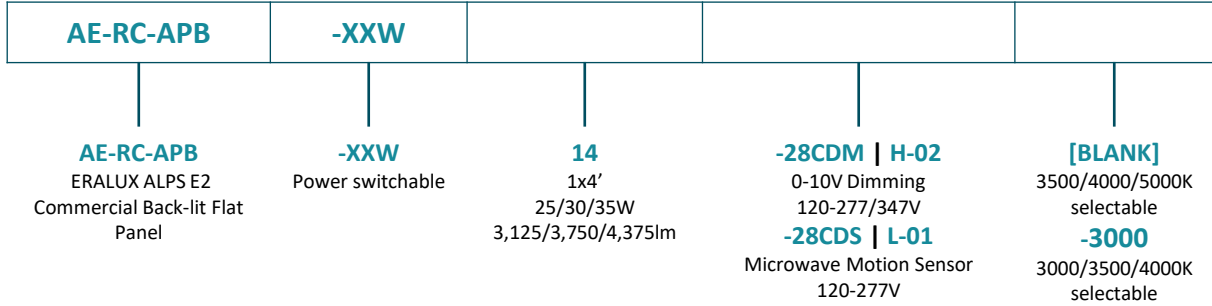

ORDERING GUIDE - ACCESSORIES

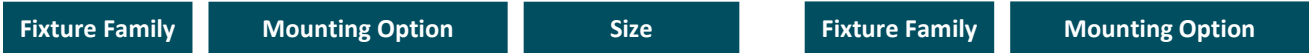
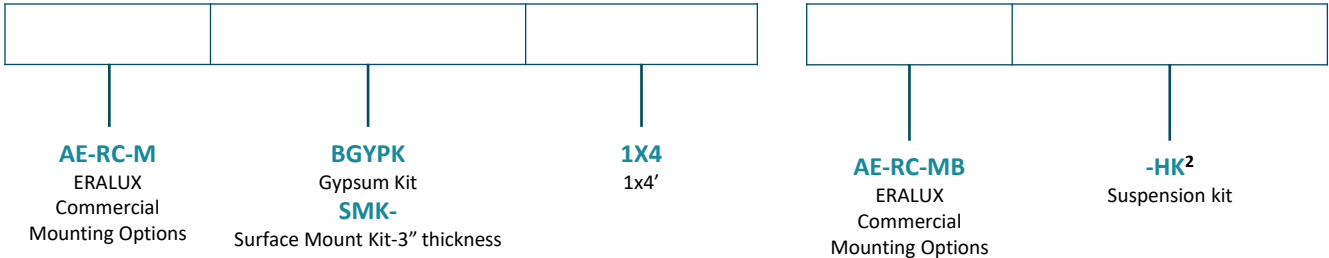

NOTES

- For more aesthetic look suspension and surface mount kit can be ordered together

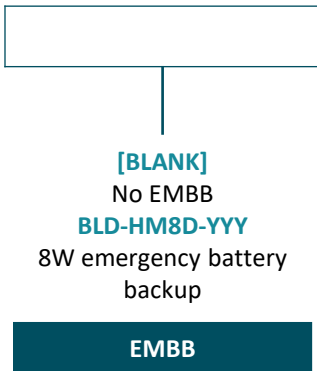

DIMENSIONS

AF-RC-APR-XXW14

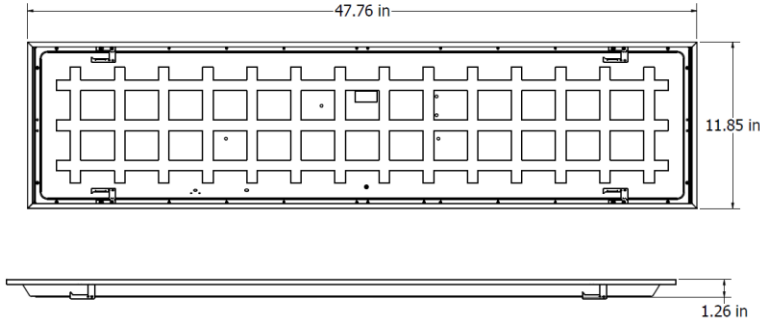

MOUNTING ACCESSORIES

Ordered separately, field installed

GYPSUM KIT

Recessed Gypsum



ORDERING CODE	DIMENSIONS		
	LENGTH	WIDTH	HEIGHT
AE-RC-MBGYPK1X4	49.1"	13.3"	1.5"

SURFACE MOUNT KIT

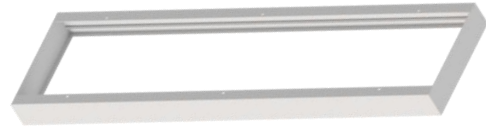

ORDERING CODE	DIMENSIONS		
	LENGTH	WIDTH	HEIGHT
AE-RC-MSMK-1X4	48"	12.2"	2.91"

SUSEPENSION KIT



ORDERING CODE	QUANTITY	DESCRIPTION	LENGTH
AE-RC-MB-HK	3 pieces/set	Aircraft cable	4'

CONTROL ACCESSORIES

Ordered separately, field installed

EMERGENCY BATTERY BACK UP

BLD-HM8D-YYY



The BLD-HMXXD-YYY series LED Emergency Driver is UL listed for field and factory installations. It switches to emergency mode during power failures, providing up to 90 minutes of lighting. With an integrated battery, charger, and converter, it delivers 8W constant power at 170VDC. Ideal for 0-10V dimmable indoor commercial LED fixtures, such as flat panels, troffers, downlights, and linear strip lights.

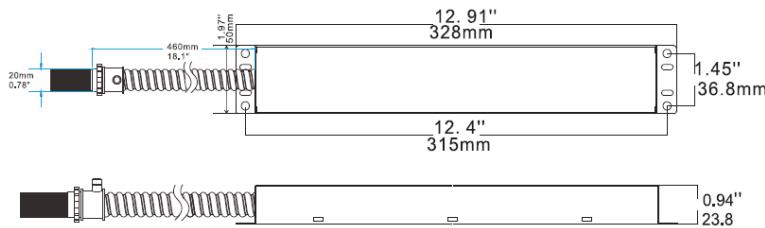

SPECIFICATIONS	
Input Voltage	100-347 Vac
Power Frequency	50/60HZ
Input Power	8W max
Output Voltage	170 VDC
Output Power	8W
Ambient Temperature	0°C to 50°C
	30°F to 122°F
Installation	Remote

ROOM OCCUPANCY SENSOR

PART NUMBER	DESCRIPTION
AE-CT-DT806	Detecta - Room Occupancy Sensor
RC102	RC102 Remote Control

SPECIFICATIONS		
Input Voltage	120-277 Vac	
Power Frequency	50/60HZ	
Rated Load	At 120 Vac	800W
	At 277 Vac	1200W
Detection Range	3-10 Meters	
	9.8- 32.8 Feet	
Standby Power	~0.9W	
Time Setting	10 sec to 30 min	
Light Control	10-2,000LUX	
Installation	Ceiling Mounted	

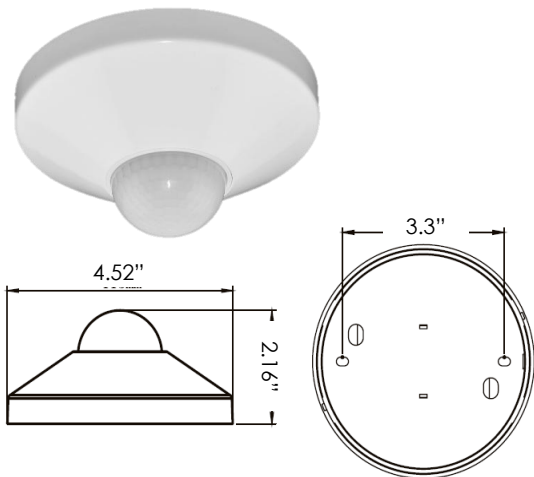

LUMEN ESTIMATE

Lumen output varies based on CCT and CRI. An estimate of lumen output of the various CCT/CRI combinations, use correction factors as per table below:

LUMEN ESTIMATE ADJUSTMENT FACTORS

CCT	3500K	4000K	5000K
80CRI	0.97	1.00	1.03

PHOTOMETRIC DATA

PART NUMBER		ZONAL LUMEN SUMMARY			POLAR LUMINOUS INTENSITY	CONE DISTRIBUTION		
AE-RC-APB-XXW14-28CDMH-01		Zone	Lumens	% Fixture	Direct Light	Center Beam Fc	Beam Width	
Wattage	35W	0-20°	547.25	12.2		1.7ft	515 fc	5.2 ft 5.9 ft
CCT	3000K	0-30°	1168.95	26.2		3.3ft	137 fc	10.0 ft 11.4 ft
Distribution	120°	0-40°	1928.56	43.1		5.0ft	59.6 fc	15.2 ft 17.2 ft
		0-60°	3462.55	77.5		6.7ft	33.2 fc	20.4 ft 23.1 ft
		0-80°	4372.16	97.8		8.3ft	21.6 fc	25.2 ft 28.6 ft
		0-90°	4466.64	99.9		10.0ft	14.9 fc	30.4 ft 34.5 ft
						■ Vert. Spread: 113.3° ■ Horiz. Spread: 119.7°		

DLC MODELS



DLC

DLC MODEL	PRODUCT ID	Primary Use	Classification
AE-RC-APB-25W14-28[CDM,CDS,CDE,CSE][L,H]-02	S-XG2TN7	1x4 Luminaires for Ambient Lighting of Interior Commercial Space	Premium
AE-RC-APB-25W14-28[RDM,RDS,RDE,RSE,CDM,CDS,CDE,CSE][L,H]-01	S-9TOLAY		Premium
AE-RC-APB-30W14-28[CDM,CDS,CDE,CSE][L,H]-02	S-QGPMO		Premium
AE-RC-APB-30W14-28[RDM,RDS,RDE,RSE,CDM,CDS,CDE,CSE][L,H]-01	S-ML7IXT		Premium
AE-RC-APB-35W14-28[CDM,CDS,CDE,CSE][L,H]-02	S-IWZNSH		Premium
AE-RC-APB-36W14-28[RDM,RDS,RDE,RSE,CDM,CDS,CDE,CSE][L,H]-01	S-HWDTKJ		Premium

OVERVIEW



Innovative Design

- Aluminum die-cast frame
- Enhanced quality diffuser ensures high efficiency light output for a clean, evenly illuminated surface

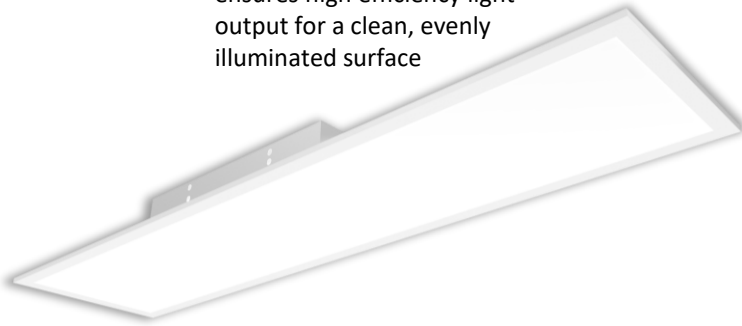

Multiple Selections

- 1x4' size
- Power Switchable.
- multiple switchable CCT options, 30 to 50K CCT

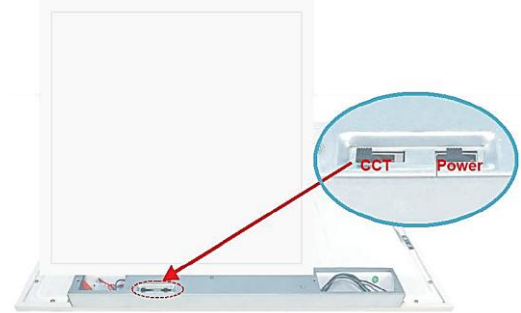

Mounting Options

- Surface Mount
- Suspended
- Recessed gypsum
- Recessed T-grid
- Suspended with surface mount kit

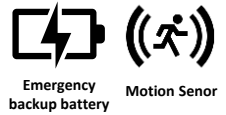
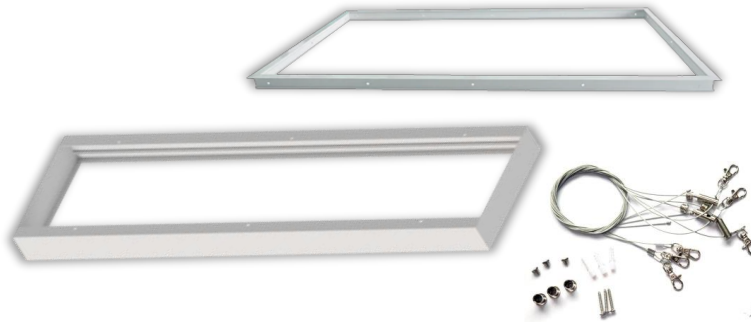

Tests And Certifications

