

# ALPS HYDRO

eralux®

## Commercial LED Lighting

### Back-Lit Panel | 1x4, 2x2

The ALPS Hydro is a backlit flat panel product designed with optimal LED placement to ensure a uniformly lit space. It features a switchable CCT and power driver that allows for endless flexibility. Wet rated, IP65 from below ceiling line, capable of being sprayed from the bottom.

Applications: Wet Location | Healthcare | Education | Food Industry

	DATE	QTY	ACC. QTY	TYPE
PROJECT				
PN				
ACCESSORY PN				
NOTES				



### DYNAMIC MENU

Ordering Guide	<a href="#">Page 2</a>
Dimensions	<a href="#">Page 3</a>
Control	<a href="#">Page 5</a>
Photometric Data	<a href="#">Page 6</a>

[Install Instructions](#)

### SPECIFICATIONS

Input Voltage	120-277/347V	
Power Factor	0.9	
Total Harmonic Distortion	<20%	
Dimming	0-10V	
CRI	80 CRI	
CCT	<div style="display: flex; gap: 10px;"> <div style="border: 1px solid #ccc; border-radius: 50%; padding: 2px 5px;">35K</div> <div style="border: 1px solid #ccc; border-radius: 50%; padding: 2px 5px;">40K</div> <div style="border: 1px solid #ccc; border-radius: 50%; padding: 2px 5px;">50K</div> </div>	
Efficacy	~125LPW	
Power	1x4	25/30/40W
	2x2	25/30/40W
Ambient Temperature Range	-20°C to 45°C	
Distribution	120°	
Mounting options <a href="#">page 4</a>	Surface Mount Suspended Recessed Gypsum Recessed T-grid	

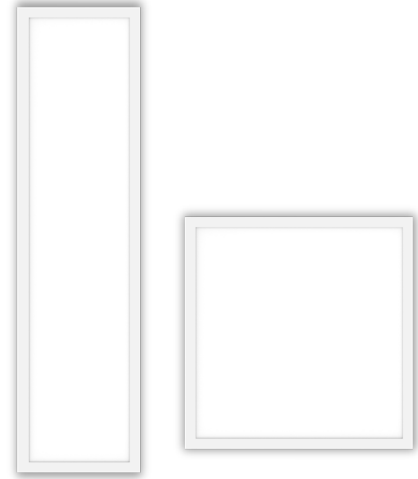

### PRODUCT FEATURES

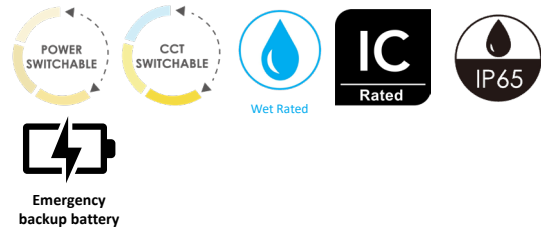

### PRODUCT CERTIFICATIONS



### SYSTEM WARRANTY – 5 YEARS

Eralux will warrant defective drivers, LEDs and boards for 5 years from the date of purchase. This warranty is valid only if the fixture is installed and used as per installation guides and specifications. If a defect is present, Eralux will send drivers and boards at no fee with a thorough replacement instructions along with instructions on the return of the defective parts back to Eralux.

### LUMEN MAINTENANCE – L70 at 50,000 hours

Rated for 70% initial lumen output at 50,000 hours of operation, operated at 25°C ambient temperature; per guidelines published by the Illuminating Engineering Society (IES).



### ORDERING GUIDE

<b>PL</b>		<b>-A3C3</b>	<b>-M</b>	<b>-P</b>
<b>PL</b> ALPS Hydro Commercial Backlit flat Panel IP65/NSF	<b>1X4   -40W</b> 1x4' 25/30/40W 3,125/3,750/4,375lm	<b>-A3C3</b> 3500/4000/5000K selectable	<b>-M</b> 120-277/347V	<b>-P</b> 0-10V Dimming
	<b>2X2   -40W</b> 2x2' 25/30/40W 3,125/3,750/4,375lm			

<b>Fixture Family</b>	<b>Size   Power</b>	<b>CCT</b>	<b>Voltage</b>	<b>Controls</b>
-----------------------	---------------------	------------	----------------	-----------------



### ORDERING GUIDE - ACCESSORIES

<b>AE-RC-M</b> ERALUX Commercial Mounting Options	<b>BGYPK</b> Gypsum Kit <b>SMK-</b> Surface Mount Kit-3" thickness	<b>1X4</b> 1x4' <b>2X2</b> 2x2'	<b>AE-RC-MB</b> ERALUX Commercial Mounting Options	<b>-HK<sup>1</sup></b> Suspension kit

<b>Fixture Family</b>	<b>Mounting Option</b>	<b>Size</b>	<b>Fixture Family</b>	<b>Mounting Option</b>
-----------------------	------------------------	-------------	-----------------------	------------------------

- NOTES** 1. For more aesthetic look suspension and surface mount kit can be ordered together

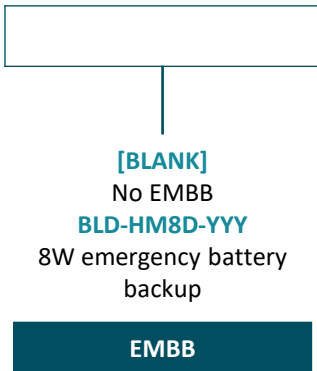

#### DIMENSIONS

PL1X4

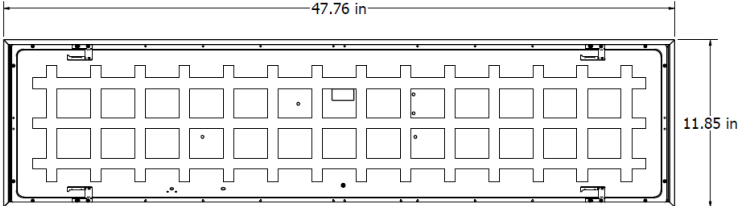

PL2X2

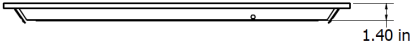
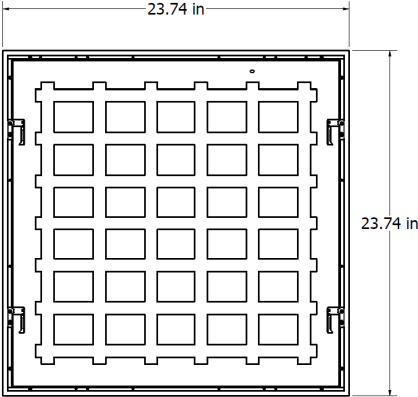

#### MOUNTING ACCESSORIES

Ordered separately, field installed

#### GYPSUM KIT

Recessed Gypsum



ORDERING CODE	DIMENSIONS			Cut out	
	LENGTH	WIDTH	HEIGHT	LENGTH	WIDTH
AE-RC-MBGYPK1X4	49.1"	13.3"	1.5"	48.3" - 48.7"	12.5" - 12.9"
AE-RC-MBGYPK2X2	25.1"	25.1"	1.5"	24.3" - 24.7"	24.3" - 24.7"

#### SURFACE MOUNT KIT

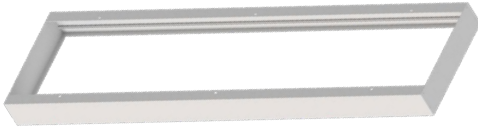

ORDERING CODE	DIMENSIONS		
	LENGTH	WIDTH	HEIGHT
AE-RC-MSMK-1X4	48"	12.2"	2.91"
AE-RC-MSMK-2X2	24"	24"	2.91"

#### SUSEPENSION KIT



ORDERING CODE	QUANTITY	DESCRIPTION	LENGTH
AE-RC-MB-HK	3 pieces/set	Aircraft cable	4'

### CONTROL ACCESSORIES

Ordered separately, field installed

### EMERGENCY BATTERY BACK UP

BLD-HM8D-YYY



The BLD-HMXXD-YYY series LED Emergency Driver is UL listed for field and factory installations. It switches to emergency mode during power failures, providing up to 90 minutes of lighting. With an integrated battery, charger, and converter, it delivers 8W constant power at 170VDC. Ideal for 0-10V dimmable indoor commercial LED fixtures, such as flat panels, troffers, downlights, and linear strip lights.

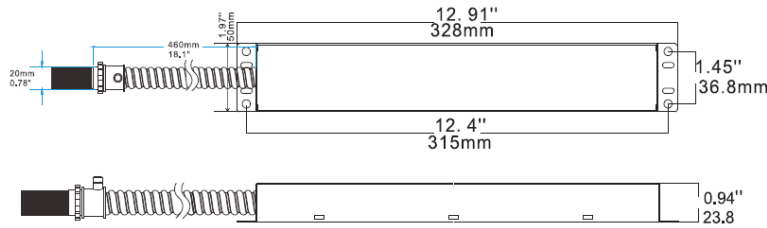

### ROOM OCCUPANCY SENSOR

PART NUMBER	DESCRIPTION
AE-CT-DT806	Detecta - Room Occupancy Sensor
RC102	RC102 Remote Control

SPECIFICATIONS	
Input Voltage	120-277 Vac
Power Frequency	50/60HZ
Rated Load	At 120 Vac   800W
	At 277 Vac   1200W
Detection Range	3-10 Meters
	9.8- 32.8 Feet
Standby Power	~0.9W
Time Setting	10 sec to 30 min
Light Control	10-2,000LUX
Installation	Ceiling Mounted

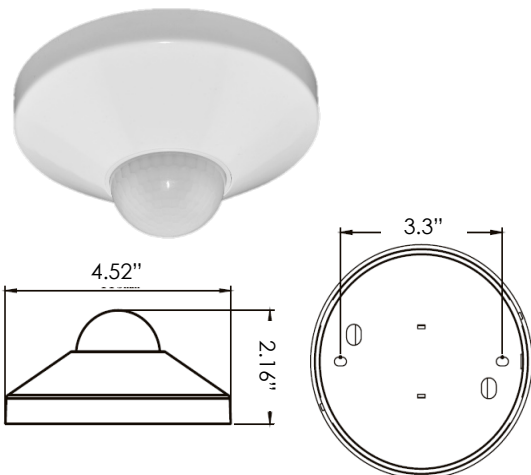

### LUMEN ESTIMATE

Lumen output varies based on CCT and CRI. An estimate of lumen output of the various CCT/CRI combinations, use correction factors as per table below:

#### LUMEN ESTIMATE ADJUSTMENT FACTORS

CCT	3500K	4000K	5000K
80CRI	0.97	1.00	1.03

### PHOTOMETRIC DATA

PART NUMBER		ZONAL LUMEN SUMMARY			POLAR LUMINOUS INTENSITY	CONE DISTRIBUTION			
PL1X4-40W-A3C3-M-P		Zone	Lumens	% Fixture	Direct Light	Center Beam Fc	Beam Width		
Wattage	40W	0-20°	423.26	12.5		1.7ft	590 fc	5.2 ft	5.2 ft
CCT	3500K	0-30°	900.73	26.6		3.3ft	157 fc	10.1 ft	10.1 ft
Distribution	120°	0-40°	1479.53	43.8		5.0ft	68.3 fc	15.3 ft	15.3 ft
		0-60°	2631.93	77.8		6.7ft	38 fc	20.5 ft	20.6 ft
		0-80°	3295.32	97.5		8.3ft	24.8 fc	25.5 ft	25.5 ft
		0-90°	3364.35	99.5		10.0ft	17.1 fc	30.7 ft	30.7 ft
						■ Vert. Spread: 113.8° ■ Horiz. Spread: 113.8°			

PART NUMBER		ZONAL LUMEN SUMMARY			POLAR LUMINOUS INTENSITY	CONE DISTRIBUTION			
PL2X2-40W-A3C3-M-P		Zone	Lumens	% Fixture	Direct Light	Center Beam Fc	Beam Width		
Wattage	40W	0-20°	403.68	12.5		1.7ft	549 fc	5.2 ft	5.2 ft
CCT	3500K	0-30°	858.97	26.6		3.3ft	146 fc	10.1 ft	10.1 ft
Distribution	120°	0-40°	1410.66	43.7		5.0ft	63.5 fc	15.3 ft	15.3 ft
		0-60°	2508.66	77.8		6.7ft	35.4 fc	20.6 ft	20.4 ft
		0-80°	3143.5	97.4		8.3ft	23 fc	25.5 ft	25.3 ft
		0-90°	3210.68	99.5		10.0ft	15.9 fc	30.7 ft	30.5 ft
						■ Vert. Spread: 113.8° ■ Horiz. Spread: 113.5°			

#### OVERVIEW



#### Innovative Design

- Aluminum die-cast frame
- Enhanced quality diffuser ensures high efficiency light output for a clean, evenly illuminated surface



#### Multiple Selections



Emergency backup battery

- 1x4' and 2x2' sizes.
- Power Switchable.
- Three CCTs options available.



#### Mounting Options

- Surface Mount
- Suspended
- Recessed gypsum
- Recessed T-grid
- Suspended with surface mount kit



Gasket



#### Tests And Certifications

