

AQX SLIM



LINEAR LED LIGHT

IP65 Architecture Linear | 2" Aperture

The AQX Slim is an architectural linear available in three sizes; 4, 6 and 8 feet, each offering different power options. It is IP65 and IK08 rated, making it suitable for use in wet or harsh environments, though it is not fully exposed to outdoor conditions. This fixture can be surface mounted or suspended, either as a standalone unit or in a continuous run.

Applications: Train Stations | Subway entrances | Above pools | Building Canopies





	DATE	QTY	ACC. QTY	TYPE
PROJECT				
PN				
NOTES				

DYNAMIC MENU

Order Information	Page 2
Dimensions	Page 3
Accessories	Page 4
Photometric Data	Page 6

[Install Instruction link](#)

SPECIFICATIONS

Input Voltage	120-277V		
Power Factor	>0.9		
Total Harmonic Distortion	<20%		
Dimming	0-10V dimming		
CRI	90 CRI		
CCT	<input type="radio"/> 30K <input type="radio"/> 35K <input type="radio"/> 40K		
Efficacy	~85-90 lm/W		
Length	4'	6'	8'
Power	31W	46W	61W
Ambient Temperature Range	-20°C to 40°C		
Mounting Options	<input type="checkbox"/> Surface <input type="checkbox"/> Suspended		
Fixture Finish	Black White Silver   		
Optics	Polycarbonate Lens		
Protection	IP65; suitable under canopies IK08; High impact resistance		
Distribution			



PRODUCT FEATURES



PRODUCT CERTIFICATIONS



SYSTEM WARRANTY – 5 YEARS

Eralux will warrant defective drivers, LEDs and boards for 5 years from the date of purchase. This warranty is valid only if the fixture is installed and used as per installation guides and specifications. If a defect is present, Eralux will send drivers and boards at no fee with a thorough replacement instructions along with instructions on the return of the defective parts back to Eralux.

LUMEN MAINTENANCE – L80 at 50,000 hours

Rated for 80% initial lumen output at 50,000 hours of operation, operated at 25°C ambient temperature; per guidelines published by the Illuminating Engineering Society (IES).

LINEAR LED LIGHT

IP65 Architecture Linear | 2" Aperture



ORDERING GUIDE

AE-SF-AQXS			-S		
AE-SF-AXQS ERALUX AQXS Linear Architectural Fixture 120-277V input voltage	-4 -31 4ft 31W 2,936 lm -6 -46 6ft 46W 4,404 lm -8 -61 8ft 61W 5,872 lm	-30 3000K -35 3500K -40 4000K	-S 6ft Power Cord Included	-WH White -BK Black -SV Silver	-AIR¹ Suspended -SMT Surface mount -AIRLINK² Suspended Continuous -SMT-LINK Surface Mount Continuous
Fixture Family	Length Power	CCT	Power Cord	Finish	Mounting

NOTES

- 1. Fixture come with 6ft Power Cord by default, two 6ft Aircraft cables and two Canopies.
- 2. Fixture come with 6ft Power Cord by default, Y-shaped connection cable , two waterproof Cable connectors, one canopy and one mechanical Link

CAUTION

- Maximum of 330W per electrical drop.

DIMENSIONS

SIZE	TOP VIEW	SIDE VIEW
4FT		
6FT		
8FT		

DIMENSIONS - MOUNTING

SIZE



DRILLING PATTERN FOR SUSPENDED MOUNT

4FT

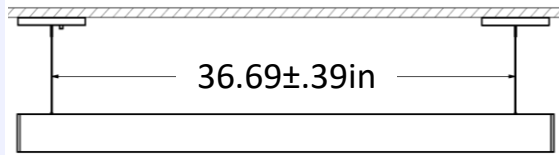

6FT

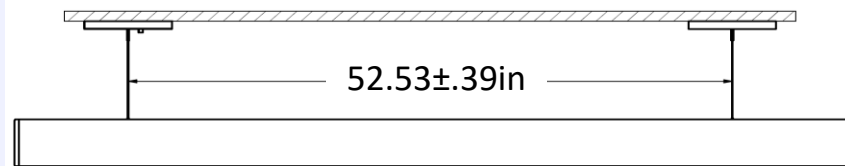

8FT

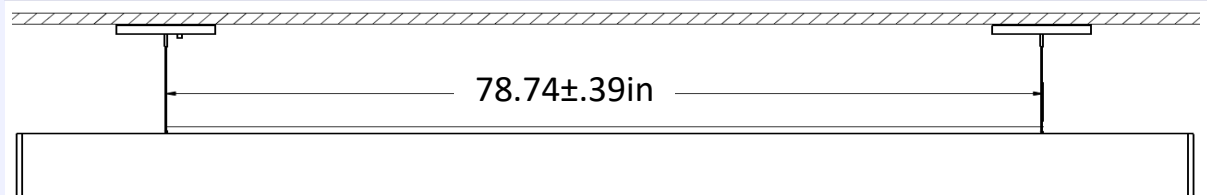

SIZE



DRILLING PATTERN FOR SURFACE MOUNT

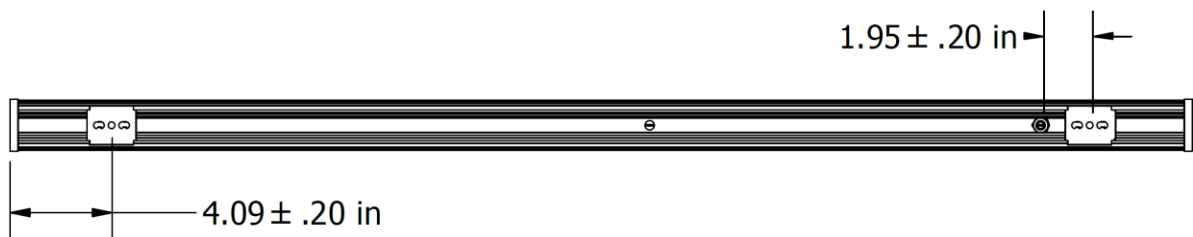

NOTES

Same distance is applied on all AQXS Sizes



LINEAR LED LIGHT

IP65 Architecture Linear | 2" Aperture

ACCESSORIES

Ordered separately if needed



FOR STAND ALONE

SUSPENSION		
ORDER CODE	DESCRIPTION	PICTURE
AE-SF-AQXS-L-PTB-PF2-6-D	Suspension Mount Kit Canopy with 2 holes 6ft Suspension wire	
AE-SF-AQXS-L-PTB-NPF-6-D	Suspension Mount Kit Canopy with 1 hole 6ft Suspension wire	

SURFACE MOUNT		
ORDER CODE	DESCRIPTION	PICTURE
AE-SF-AQXS-SMK	Surface Mount Bracket	

FOR CONTINUOUS RUN

Ordered separately if needed

LINK		
ORDER CODE	DESCRIPTION	PICTURE
AE-SF-AQXS-BV-MV20-5	5-Pin Dimmable waterproof cable connector	
AE-SF-AQXS-L-CH-IP24-5	8FT 5-PIN Y-shaped connection cable	
AE-SF-AQXS-LINK	Linkable Metal Accessory For Continuous Runs	

CONTINUOUS RUNS INSTALLATION

ELECTRICAL CONNECTION

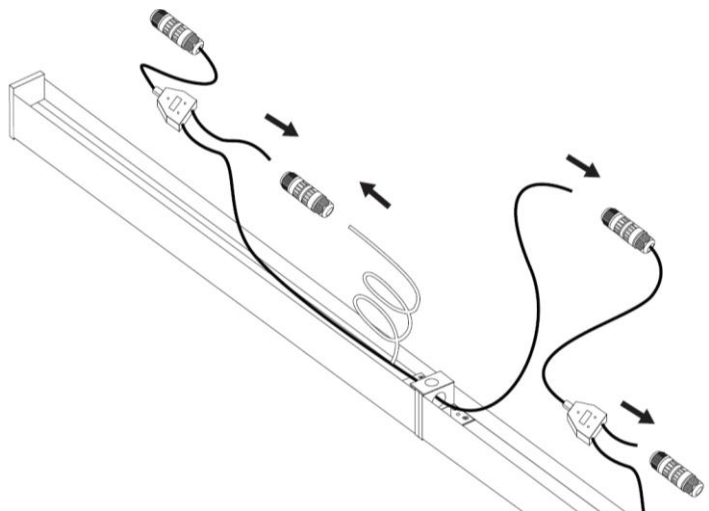

COMPONENTS



NOTES

- #1 Connection cable for every connection
- #2 Dimmable waterproof connector per cable

MECHANICAL CONNECTION

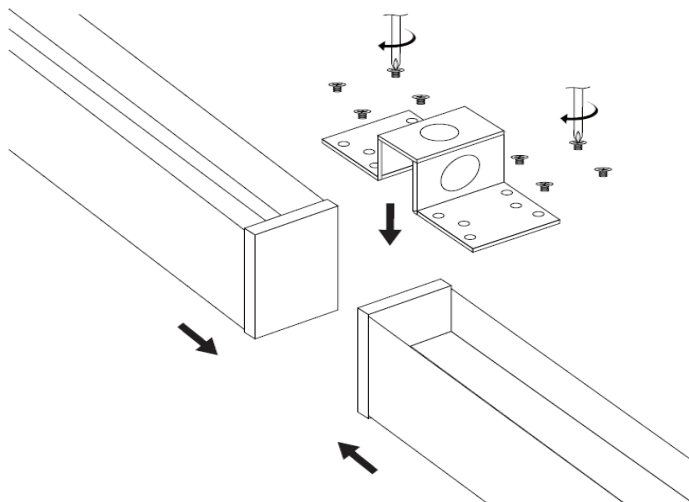

COMPONENTS



NOTES

- Easily installed.
- No need to remove endcaps.
- One link is needed per connection.

LUMEN ESTIMATE

Lumen output varies based on CCT and CRI. An estimate of lumen output of the various CCT/CRI combinations, use correction factors as per table below:

LUMEN ESTIMATE ADJUSTMENT FACTORS

CCT	3000K	3500K	4000K
PREMIUM (90CRI)	0.94	0.97	1

PHOTOMETRIC DATA

PART NUMBER		ZONAL LUMEN SUMMARY			POLAR LUMINOUS INTENSITY	CONE DISTRIBUTION			
AE-SF-AQXS-4-31-40-D-XX-XX		Zone	Lumens	% Fixture	Direct Light	Center Beam Fc	Beam Width		
Wattage	31W	0-20°	421.01	13.3		1.7ft	402 fc	4.7 ft	4.6 ft
CCT	4000K	0-30°	886.27	28		3.3ft	107 fc	9.2 ft	8.9 ft
Distribution	108°	0-40°	1437.69	45.4		5.0ft	46.4 fc	13.9 ft	13.5 ft
Length	4ft	0-60°	2501.04	79		6.7ft	25.9 fc	18.6 ft	18.1 ft
		0-80°	3086.16	97.5		8.3ft	16.9 fc	23.0 ft	22.4 ft
		0-90°	3140.63	99.2	10.0ft	11.6 fc	27.7 ft	27.0 ft	
						■ Vert. Spread: 108.4° ■ Horiz. Spread: 106.9°			
AE-SF-AQXS-6-46-40-D-XX-XX		Zone	Lumens	% Fixture	Direct Light	Center Beam Fc	Beam Width		
Wattage	46W	0-20°	624.72	13.3		1.7ft	596 fc	4.7 ft	4.6 ft
CCT	4000K	0-30°	1315.12	28		3.3ft	158 fc	9.2 ft	8.9 ft
Distribution	108°	0-40°	2133.36	45.4		5.0ft	68.9 fc	13.9 ft	13.5 ft
Length	6ft	0-60°	3711.25	79		6.7ft	38.4 fc	18.6 ft	18.1 ft
		0-80°	4579.5	97.5		8.3ft	25 fc	23.0 ft	22.4 ft
		0-90°	4660.32	99.2	10.0ft	17.2 fc	27.7 ft	27.0 ft	
						■ Vert. Spread: 108.4° ■ Horiz. Spread: 106.9°			
AE-SF-AQXS-8-61-40-D-XX-XX		Zone	Lumens	% Fixture	Direct Light	Center Beam Fc	Beam Width		
Wattage	61W	0-20°	799.41	13.3		1.7ft	763 fc	4.7 ft	4.6 ft
CCT	4000K	0-30°	1682.87	28		3.3ft	202 fc	9.2 ft	8.9 ft
Distribution	108°	0-40°	2729.91	45.4		5.0ft	88.2 fc	13.9 ft	13.5 ft
Length	8ft	0-60°	4749.03	79		6.7ft	49.1 fc	18.6 ft	18.1 ft
		0-80°	5860.07	97.5		8.3ft	32 fc	23.0 ft	22.4 ft
		0-90°	5963.5	99.2	10.0ft	22 fc	27.7 ft	27.0 ft	
						■ Vert. Spread: 108.4° ■ Horiz. Spread: 106.9°			

OVERVIEW



Innovative Design

- Extruded aluminum housing for better heat dissipation.
- Highly durable polycarbonate and high transmittance lens.



Slim Profile



Multiple Options

- Three standard length available; 4, 6, & 8ft.
- 30/35/40/50K Options
- Black, white & silver.



Mountings Available

- Suspended.
- Wall mount



FEATURES

- Protected against dust ingress.
- Protected against water jets
- Impact resistant



Tests And Certifications

