

ATHENA

OUTDOOR LED LIGHT

Stadium Light | 200W → 1200W

The ATHENA is a versatile modular outdoor sports light designed to meet various project needs. With variety of beam angles, sizes and compact design, it allows for quick, flexible assembly and installation. Ideal for sports fields, stadiums, plazas, and other large outdoor spaces. Available in multiple of power options from 200W to 1200W with around 140 Lm/W. It suitable for harsh and wet environment.

Applications: Stadium | Football Field | Tennis Court | Baseball Field | Outdoor theater

eralux®

	DATE	QTY	ACC. QTY	TYPE
PROJECT				
PN				
ACCESSORY PN				
NOTES				



DYNAMIC MENU

Order Information	Page 2
Dimensions	Page 6
Accessories	Page 9
Photometric Data	Page 10

[Install Instruction link](#)

SPECIFICATIONS

Input Voltage	120-277V 277-480V
Power Factor	>0.92
Total Harmonic Distortion	<20%
Dimming	0-10V dimming
CRI	70 CRI
CCT	<div style="display: flex; gap: 10px;"> <div style="border: 1px solid gray; border-radius: 50%; padding: 2px 5px;">40K</div> <div style="border: 1px solid gray; border-radius: 50%; padding: 2px 5px;">50K</div> </div>
Efficacy	125-140 lm/W
Power	200 400 600 800 1200W
Ambient Temperature Range	-30°C to 40°C
Mounting Options	Bracket mount Pole mount
Mounting Brackets	Slip fitter U bracket
Fixture Finish	Silver 
Protection	IP66; water and dust resistance IK08; impact resistance 10KV surge protector
Beam Angle	10° 15° 30° 45° 60°



PRODUCT FEATURES



PRODUCT CERTIFICATIONS



Design Lights Consortium® (DLC) qualified product. Not all versions of this product may be DLC qualified. Please check the DLC Qualified Products List at www.designlights.org/QPL to confirm which versions are qualified" [page 3](#)

SYSTEM WARRANTY – 5 YEARS

Eralux will warrant defective drivers, LEDs and boards for 5 years from the date of purchase. This warranty is valid only if the fixture is installed and used as per installation guides and specifications. If a defect is present, Eralux will send drivers and boards at no fee with a thorough replacement instructions along with instructions on the return of the defective parts back to Eralux.

LUMEN MAINTENANCE – L90 at 53,000 hours

Rated for 90% initial lumen output at 53,000 hours of operation, operated at 25°C ambient temperature; per guidelines published by the Illuminating Engineering Society (IES).

OUTDOOR LED LIGHT

Stadium Light | 200W → 1200W



ORDERING GUIDE

AE-SP-AH					-010	-SV
AE-SP-AH ERALUX ATHENA Outdoor Stadium Light	-200 200W 25,000lm 28,000 lm	-10 10° 125 Lm/W	-740 70 CRI 4000K	[BLANK] 100-277 V	-010 0-10 V dimming	-SV Silver
	-400 400W 50,000lm 56,000lm	-15 15° 125 Lm/W	-750 70 CRI 5000K	-HV 277-480 Vac		
	-600 600W 75,000lm 84,000lm	-30 30° 140 Lm/W				
	-800 800W 100,000lm 112,000lm	-45 45° 140 Lm/W				
	-1200 1200W 150,000lm 168,000 lm	-60 60° 140 Lm/W				

Fixture Family	Power	Beam Angle	CCT & CRI	Input Voltage	Control	Finish
----------------	-------	------------	-----------	---------------	---------	--------

NOTES

- The beam angle affects the lumen output at a specific Power.
- U bracket is supplied with the fixture by default
- If a slip fitter is required , it is ordered separately



ORDERING GUIDE - ACCESSORIES

AE-SP-AH	-VS
ERALUX ATHENA Outdoor Stadium Light	Visor for single LED module
	-SR Safety rope
	-SF-SV Silver slip fitter
	-LASER Laser pointer

Accessory Family	Accessory
------------------	-----------

NOTES

- Ordered separately if needed

OUTDOOR LED LIGHT

Stadium Light | 200W → 1200W

EPA (Effective Project Area)

POWER	FIXTURE BODY EPA (FT ²)	FIXTURE WEIGHT	DRIVER BOX EPA (FT ²)	DRIVER WEIGHT
200W	0.60	9.02±0.66lbs	N/A	N/A
400W	1.34	20.68±0.66lbs	N/A	N/A
600W	1.96	33.66±0.66lbs	N/A	N/A
800W	2.74	47.74±0.66lbs	2.09	27.94±0.66lb
1200W	3.87	58.52±0.66lbs	2.09	27.94±0.66lb



DLC			
DLC MODEL	PRODUCT ID	Primary Use	Classification
AE-SP-AH-200-30-740	S-03WLXQ	Architectural Flood and Spot Luminaires	Premium
AE-SP-AH-200-45-740	S-14TNHS		Premium
AE-SP-AH-200-60-740	S-FZP5H		Premium
AE-SP-AH-200-30-750	S-4TZ2B8		Premium
AE-SP-AH-200-45-750	S-3NM7MK		Premium
AE-SP-AH-200-60-750	S-VC61Q0		Premium
AE-SP-AH-200-30-740-HV	S-X0Y85Y		Premium
AE-SP-AH-200-45-740-HV	S-FBV8Z5		Premium
AE-SP-AH-200-60-740-HV	S-BF6H3C		Premium
AE-SP-AH-200-30-750-HV	S-2NH2F		Premium
AE-SP-AH-200-45-750-HV	S-NRFYFB		Premium
AE-SP-AH-200-60-750-HV	S-R27FCD		Premium
AE-SP-AH-400-30-740	S-CBQBHH		Premium
AE-SP-AH-400-45-740	S-B9D8GV		Premium
AE-SP-AH-400-60-740	S-3FJ6QR		Premium
AE-SP-AH-400-30-750	S-7R3Z0L		Premium
AE-SP-AH-400-45-750	S-ZI2XLN		Premium
AE-SP-AH-400-60-750	S-LPW3SM		Premium
AE-SP-AH-400-30-740-HV	S-SHQYRW		Premium
AE-SP-AH-400-45-740-HV	S-D7MX08		Premium
AE-SP-AH-400-60-740-HV	S-0K03TP	Premium	
AE-SP-AH-400-30-750-HV	S-B2W99J	Premium	
AE-SP-AH-400-45-750-HV	S-1JN48C	Premium	
AE-SP-AH-400-60-750-HV	S-VKFB5K	Premium	



DLC			
DLC MODEL	PRODUCT ID	Primary Use	Classification
AE-SP-AH-600-30-740	S-52W37J	Architectural Flood and Spot Luminaires	Premium
AE-SP-AH-600-45-740	S-T8042Y		Premium
AE-SP-AH-600-60-740	S-ZGNSZH		Premium
AE-SP-AH-600-30-750	S-CZRNVL		Premium
AE-SP-AH-600-45-750	S-LFJQH9		Premium
AE-SP-AH-600-60-750	S-4F8F2F		Premium
AE-SP-AH-600-30-740-HV	S-VLRKJJ		Premium
AE-SP-AH-600-45-740-HV	S-BQ1TQG		Premium
AE-SP-AH-600-60-740-HV	S-SWYSWK		Premium
AE-SP-AH-600-30-750-HV	S-8MSDNR		Premium
AE-SP-AH-600-45-750-HV	S-Z87TB5		Premium
AE-SP-AH-600-60-750-HV	S-4GPNCZ		Premium
AE-SP-AH-800-30-740	S-16V0RS		Premium
AE-SP-AH-800-45-740	S-8MDJX1		Premium
AE-SP-AH-800-60-740	S-CZ7QJS		Premium
AE-SP-AH-800-30-750	S-NPCRZZ		Premium
AE-SP-AH-800-45-750	S-QH9PGN		Premium
AE-SP-AH-800-60-750	S-MD3SDK		Premium
AE-SP-AH-800-30-740-HV	S-YV0JT3		Premium
AE-SP-AH-800-45-740-HV	S-NX3Z42		Premium
AE-SP-AH-800-60-740-HV	S-1XLH3P	Premium	
AE-SP-AH-800-30-750-HV	S-KSVXBS	Premium	

OUTDOOR LED LIGHT

Stadium Light | 200W → 1200W

DLC MODELS



DLC			
DLC MODEL	PRODUCT ID	Primary Use	Classification
AE-SP-AH-800-45-750-HV	S-WBG8MB	Architectural Flood and Spot Luminaires	Premium
AE-SP-AH-800-60-750-HV	S-XP13D4		Premium
AE-SP-AH-1200-30-740	S-L7RF57		Premium
AE-SP-AH-1200-45-740	S-32BV1D		Premium
AE-SP-AH-1200-60-740	S-LRB4TH		Premium
AE-SP-AH-1200-30-750	S-3L2HVL		Premium
AE-SP-AH-1200-45-750	S-KXSPR6		Premium
AE-SP-AH-1200-60-750	S-4CJPK0		Premium
AE-SP-AH-1200-30-740-HV	S-4V95NP		Premium
AE-SP-AH-1200-45-740-HV	S-75442S		Premium
AE-SP-AH-1200-60-740-HV	S-SDQ6L9		Premium
AE-SP-AH-1200-30-750-HV	S-RJD45S		Premium
AE-SP-AH-1200-45-750-HV	S-TST1TR		Premium
AE-SP-AH-1200-60-750-HV	S-XH8L8N		Premium

OUTDOOR LED LIGHT

Stadium Light | 200W → 1200W

DIMENSIONS

FIXTURE



DRILLING PATTERN

200W

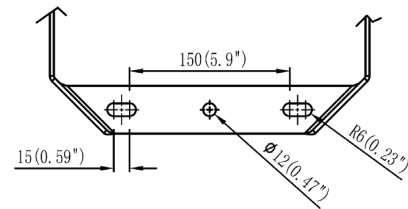
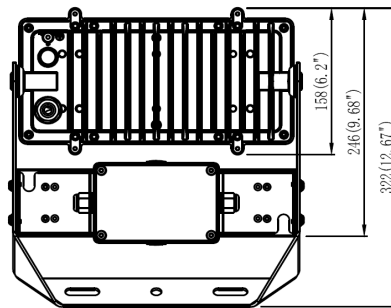
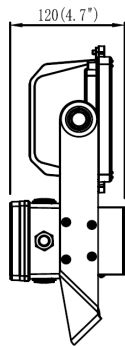
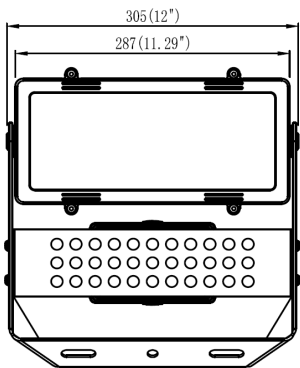

400W

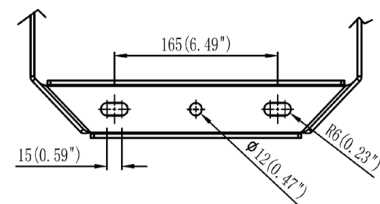
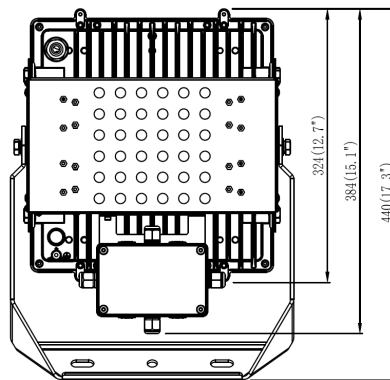
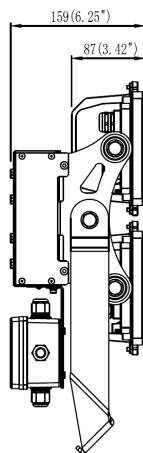
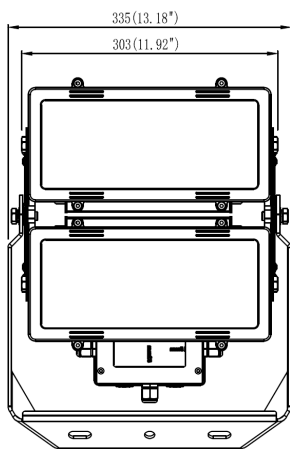

DIMENSIONS

FIXTURE



DRILLING PATTERN

600W

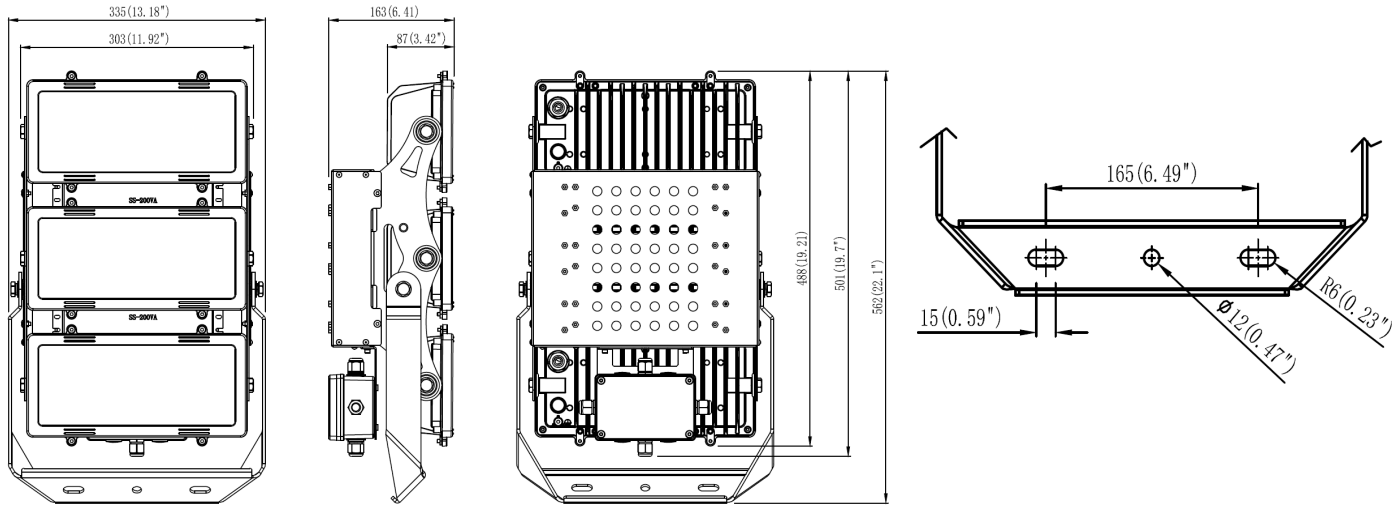

800W

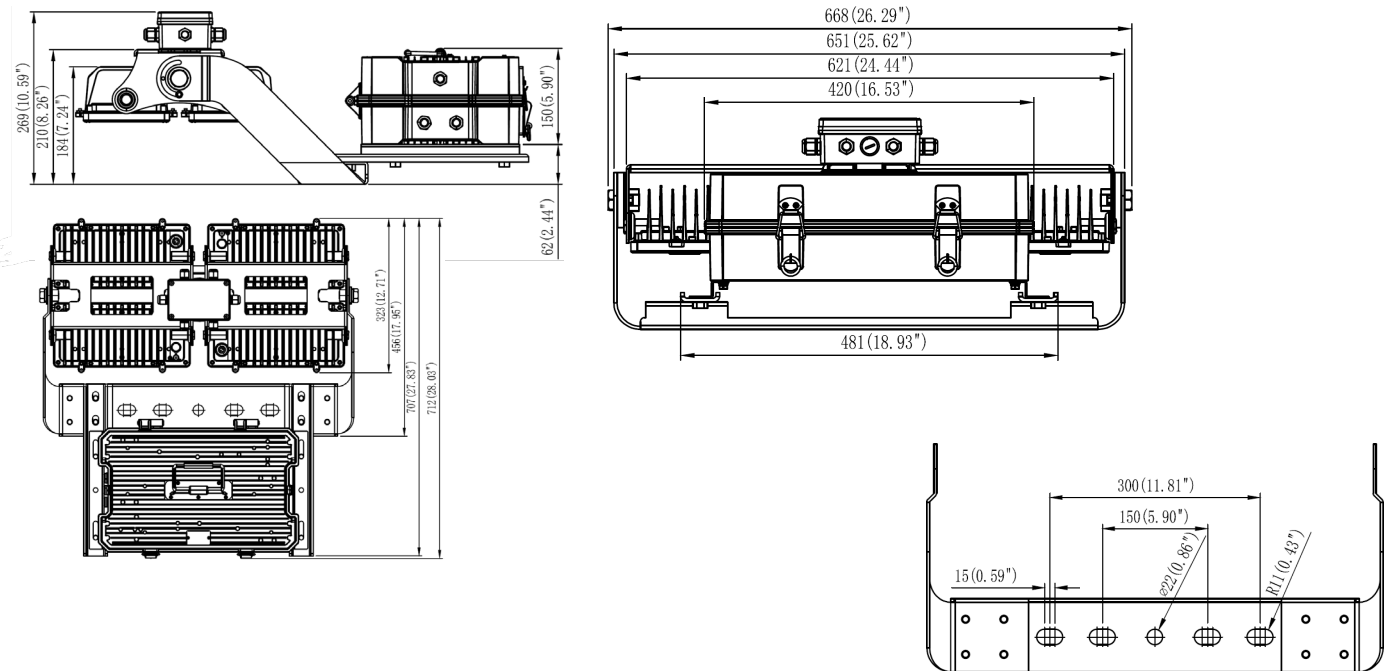

OUTDOOR LED LIGHT

Stadium Light | 200W → 1200W

DIMENSIONS

FIXTURE



DRILLING PATTERN

1200W

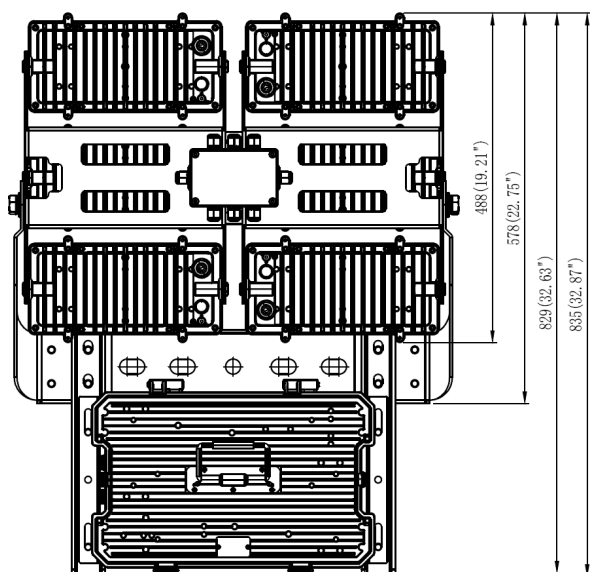
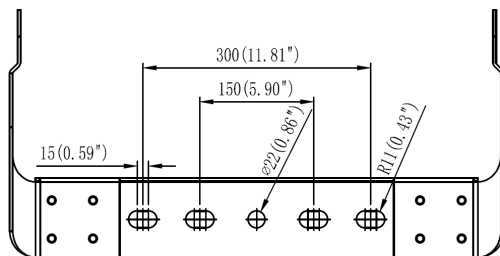
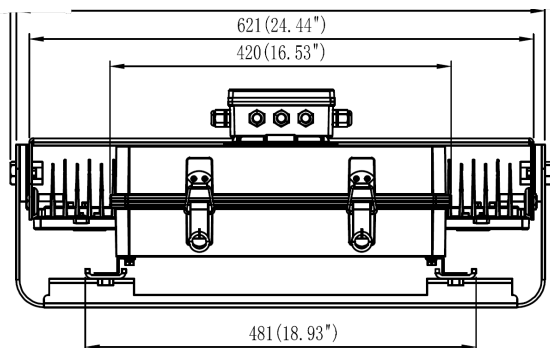
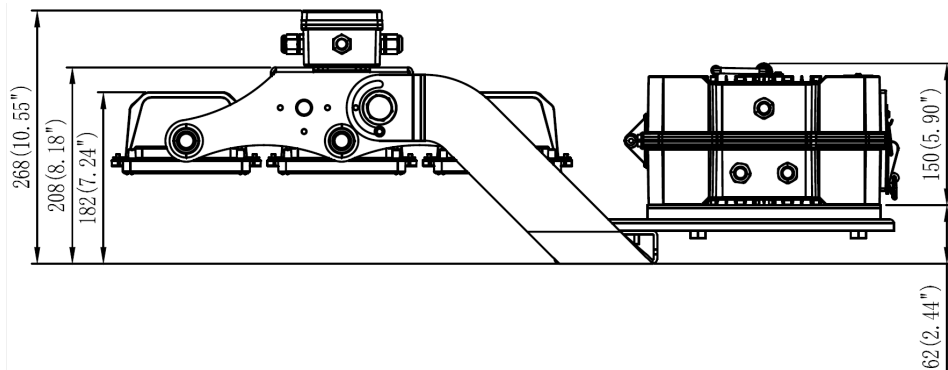

ACCESSORIES

OPTICAL SHIELD

Code	Description	Picture
AE-OD-SP-AH-VS	<p>Visor designed to reduce glare and light spill; blocking the light from going too much on the sides or above.</p>	
AE-OD-SP-AH-SF	Safety rope	
AE-OD-SP-AH-SF-SV	<p>Slip fitter Available for easy installation on top of a pole.</p>	

OUTDOOR LED LIGHT

Stadium Light | 200W → 1200W

PHOTOMETRIC DATA

PART NUMBER		ZONAL LUMEN SUMMARY			POLAR LUMINOUS INTENSITY
AE-SP-AH-1200-10-750-SV		Zone	Lumens	% Fixture	10°
Wattage	1200W	0-20°	114655.5	79.9	
CCT	5000K	0-30°	126154.7	87.9	
Distribution	10°	0-40°	132896	92.6	
		0-60°	140453.9	97.8	
		0-80°	143410.4	99.9	
		0-90°	143559.5	100	

LUMEN ESTIMATE

LUMEN ESTIMATE ADJUSTMENT FACTORS	
CCT	PREMIUM (80CRI)
4000K	0.97
5000K	1.00

Lumen output varies based on CCT and CRI. An estimate of lumen output of the various CCT/CRI combinations, use correction factors as per table below:

CONE DISTRIBUTION			ISO FOOTCANDLE PLOT	
Center Beam Fc	Beam Width		Distances are in units of mounting height 30ft	
5.0ft	90262 fc	1.0 ft 1.0 ft		
10.0ft	22565 fc	2.0 ft 1.9 ft		
15.0ft	10029 fc	3.0 ft 2.9 ft		
20.0ft	5641 fc	4.0 ft 3.9 ft		
25.0ft	3610 fc	5.0 ft 4.9 ft		
30.0ft	2507 fc	5.9 ft 5.8 ft		
■ Vert. Spread: 11.3° ■ Horiz. Spread: 11.1°			■ 20 fc ■ 10 fc ■ 5 fc ■ 1 fc	

PART NUMBER		ZONAL LUMEN SUMMARY			POLAR LUMINOUS INTENSITY
AE-SP-AH-1200-15-750-SV		Zone	Lumens	% Fixture	15°
Wattage	1200W	0-20°	108448.5	75.9	
CCT	5000K	0-30°	122152	85.5	
Distribution	15°	0-40°	130125.9	91.1	
		0-60°	139327.2	97.6	
		0-80°	142654.8	99.9	
		0-90°	142802.2	100	

CONE DISTRIBUTION			ISO FOOTCANDLE PLOT	
Center Beam Fc	Beam Width		Distances are in units of mounting height 30ft	
5.0ft	47728 fc	1.4 ft 1.4 ft		
10.0ft	11932 fc	2.9 ft 2.8 ft		
15.0ft	5303 fc	4.3 ft 4.2 ft		
20.0ft	2983 fc	5.7 ft 5.6 ft		
25.0ft	1909 fc	7.1 ft 7.0 ft		
30.0ft	1326 fc	8.6 ft 8.4 ft		
■ Vert. Spread: 16.2° ■ Horiz. Spread: 16.0°			■ 20 fc ■ 10 fc ■ 5 fc ■ 1 fc	

OUTDOOR LED LIGHT

Stadium Light | 200W → 1200W

PHOTOMETRIC DATA

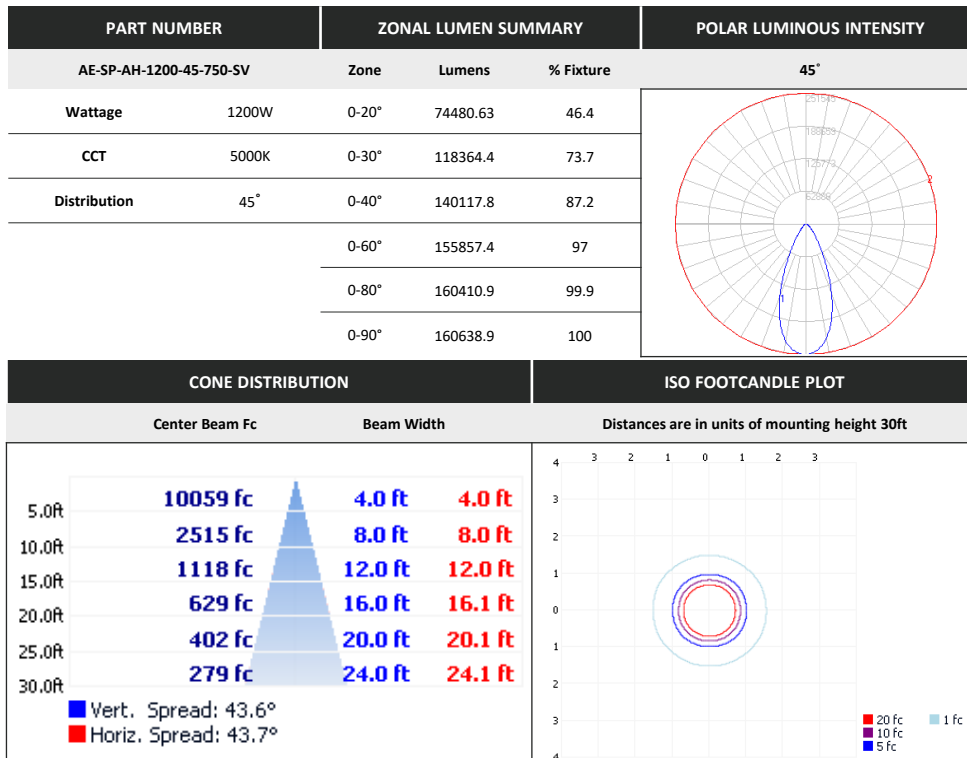
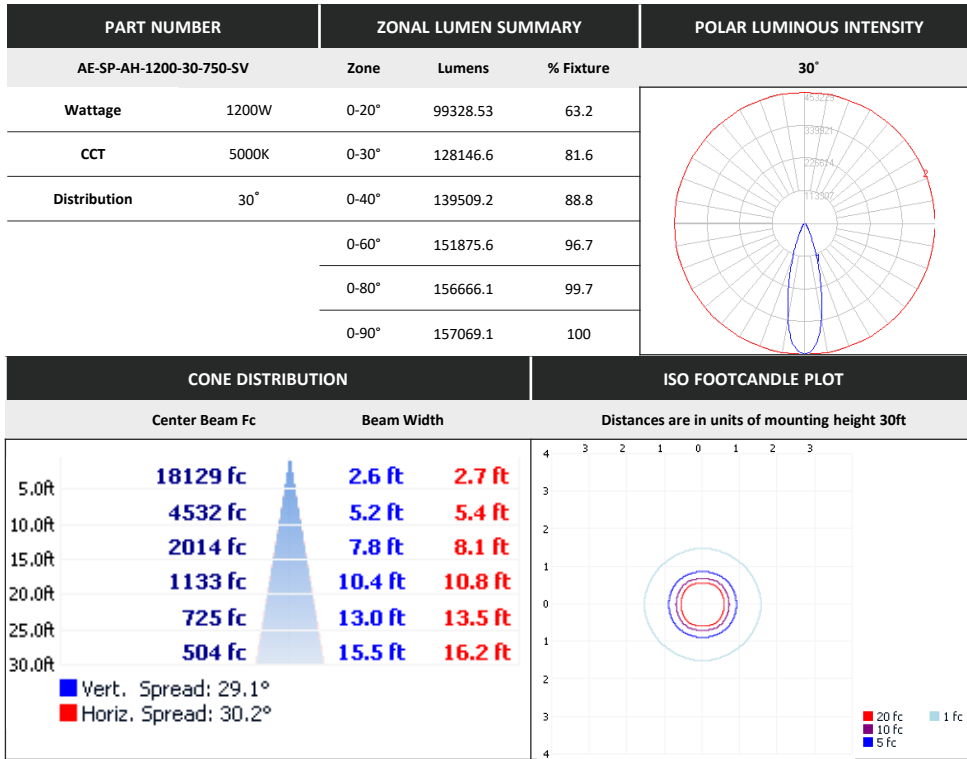

OUTDOOR LED LIGHT

Stadium Light | 200W → 1200W

PHOTOMETRIC DATA

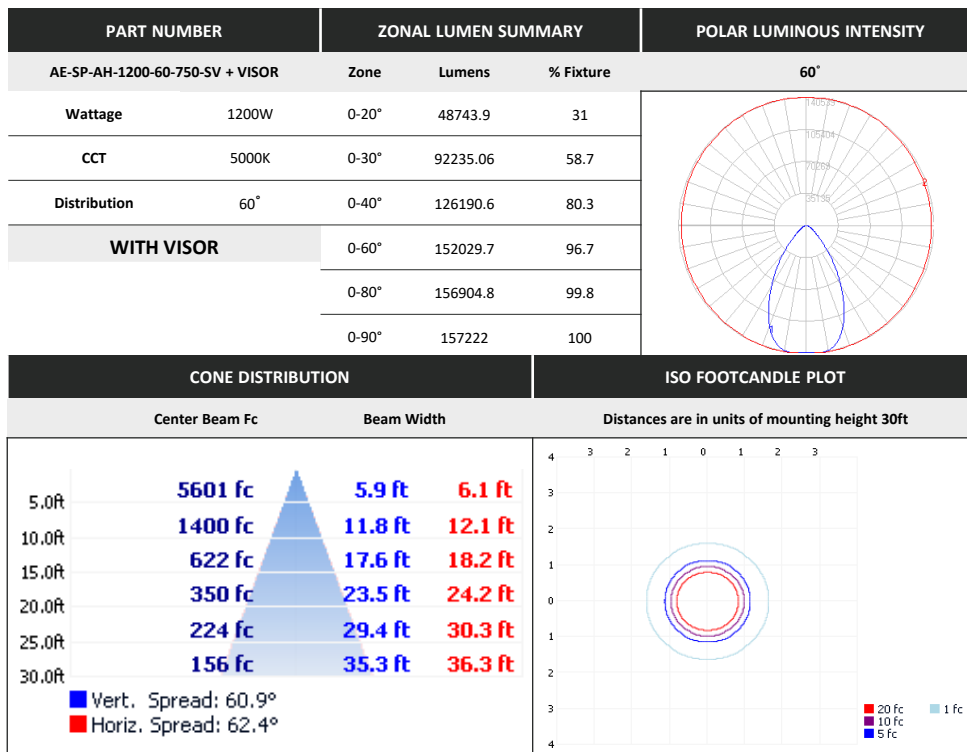
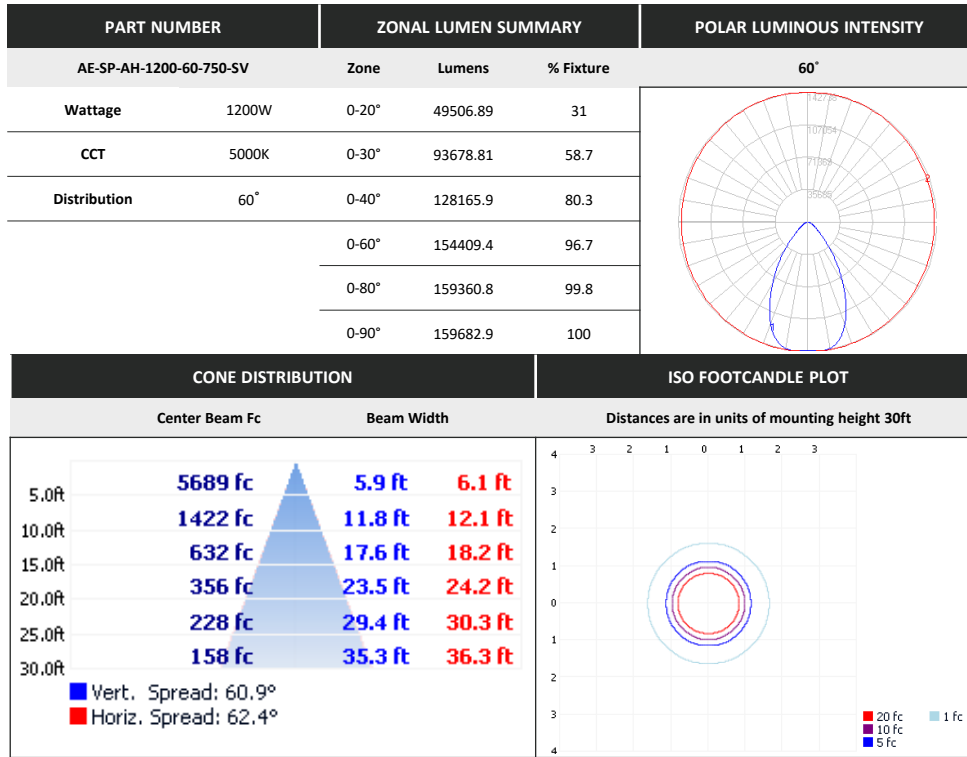

COMPATIBLE CONTROLS SYSTEM

PPA104S

Aria Plus Bluetooth based control system with dimming and lighting schedule Zone Controller

Refer to Lighting control (Aria) spec sheet for more information

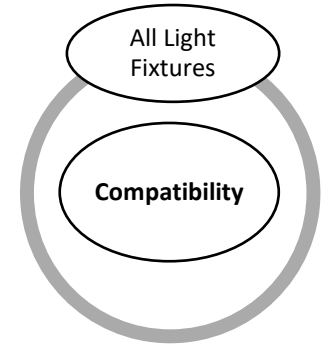

The PPA104S Series Bluetooth zone controllers feature a 20A relay for controlling higher capacity loads than standard fixture controllers.

PARAMETERS	
Input Voltage	120-277V
Input Power	2400W @ 120V 5540W @ 277V
Output Current	20A Max
Dimming	Class 2, 0-10V
Bluetooth Transmit	200ft Max
Application	Indoor
Operating Temperature	-30°C to 55°C
IP Rating	IP20 ¹
Installation	Flat Surface
Knockout	½ inch US standard

Features
½ inch US standard knockout
high-efficiency switching power supply and a 20A relay
Can power up to 2400W @ 120V total power fixtures (ex: 100 of 24W fixtures)
Turn on/off and dim the fixtures
External 0-10V dimming port allows sink current 48.5 mA
Lighting schedule

¹ Controller must be enclosed for outdoor use. Enclosure not provided.

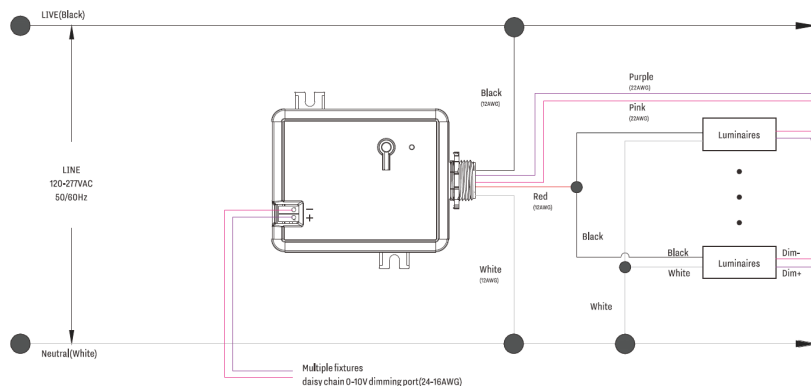

OUTDOOR LED LIGHT

Stadium Light | 200W → 1200W

OVERVIEW



Innovative Design

- Aluminum die cast housing and fins for better heat dissipation
- Highly robust polycarbonate and high transmittance lens



Multiple Options

- Six different powers from 200 to 1200W
- Visor
- Variety of beam angles
- 2 CCT Options are available 4000k & 5000k



Mountings Available

- Round Pole Mount
- Wall mount

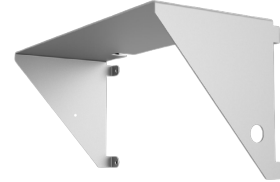

Brackets

- Slip Fitter
- U – Bracket; adjustable tilt



Distribution

- 10° | 15° | 30° | 45° | 60°



Tests And Certifications



Protection



- Protected against dust ingress.
- Protected against water jets
- Impact resistant
- 10KV surge protector

