

# ECLIPSE

DECORATIVE LIGHT

CASA SERIES | Surface/Stem Mount Downlight

eralux®

	DATE	QTY	ACC. QTY	TYPE
PROJECT				
PN	CS-EC-15-24W-BKGD			
ACCESSORY PN				
NOTES				



## DYNAMIC MENU

Order Information	<a href="#">Page 2</a>
Dimensions	<a href="#">Page 2</a>
Photometric Data	<a href="#">Page 3</a>

[Install Instruction link](#)

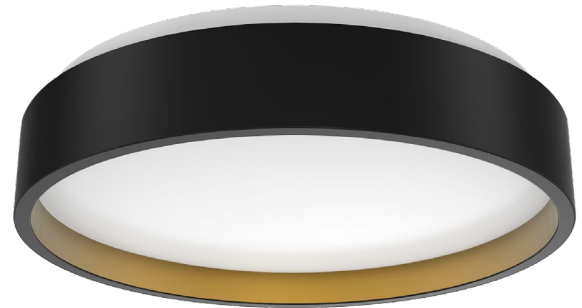

## SPECIFICATIONS

Input Voltage	120V
Power Factor	>0.7
Total Harmonic Distortion	<20%
Dimming	TRIAC dimming
CRI	80 CRI
CCT	<div style="display: flex; gap: 10px;"> <div style="border: 1px solid black; border-radius: 50%; width: 20px; height: 20px; background-color: #fff9c4; display: flex; align-items: center; justify-content: center;">27K</div> <div style="border: 1px solid black; border-radius: 50%; width: 20px; height: 20px; background-color: #fff176; display: flex; align-items: center; justify-content: center;">30K</div> <div style="border: 1px solid black; border-radius: 50%; width: 20px; height: 20px; background-color: #fff9c4; display: flex; align-items: center; justify-content: center;">35K</div> <div style="border: 1px solid black; border-radius: 50%; width: 20px; height: 20px; background-color: #bbdefb; display: flex; align-items: center; justify-content: center;">40K</div> <div style="border: 1px solid black; border-radius: 50%; width: 20px; height: 20px; background-color: #bbdefb; display: flex; align-items: center; justify-content: center;">50K</div> </div>
Efficacy	~60 lm/w
Diameter	15-inch
Power	24W
Ambient Temperature Range	-20°C to 40°C
Mounting Options	Surface mount
	Stem mount
Fixture Finish	Black housing and Gold reflector 

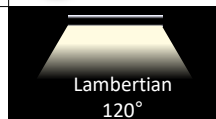

## PRODUCT FEATURES



## PRODUCT CERTIFICATIONS



## SYSTEM WARRANTY – 3 YEARS

Eralux will warrant defective drivers, LEDs and boards for 3 years from the date of purchase. This warranty is valid only if the fixture is installed and used as per installation guides and specifications. If a defect is present, Eralux will send drivers and boards at no fee with a thorough replacement instructions along with instructions on the return of the defective parts back to Eralux.

## LUMEN MAINTENANCE – L80 at 54,000 hours

Rated for 80% initial lumen output at 54,000 hours of operation, operated at 25°C ambient temperature; per guidelines published by the Illuminating Engineering Society (IES).



#### ORDERING GUIDE

<b>CS-EC</b>	<b>-15</b>	<b>-24W</b>	<b>-BK</b>	<b>GD</b>
<b>CS-EC</b> Eclipse Decorative Downlight	<b>-15</b> 15-inch Diameter	<b>-24W</b> 24W   1400 lm	<b>-BK</b> Matte Black	<b>GD</b> Brushed Brass
27/30/35/40/50K CCT Switchable				

<b>Fixture Family</b>	<b>Size</b>	<b>Power</b>	<b>Finish</b>	<b>Reflector</b>
-----------------------	-------------	--------------	---------------	------------------



#### ORDERING GUIDE - ACCESSORY

<b>CS-EC</b> Eclipse Decorative Downlight	<b>-STEM-KIT</b>	<b>-BK</b> Matte Black

<b>Fixture Family</b>	<b>Accessory</b>	<b>Finish</b>
-----------------------	------------------	---------------

#### DIMENSIONS - FIXTURE

CS-EC-15-24W

FRONT VIEW

SIDE VIEW

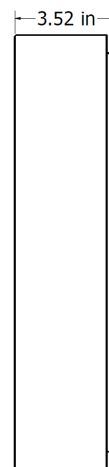
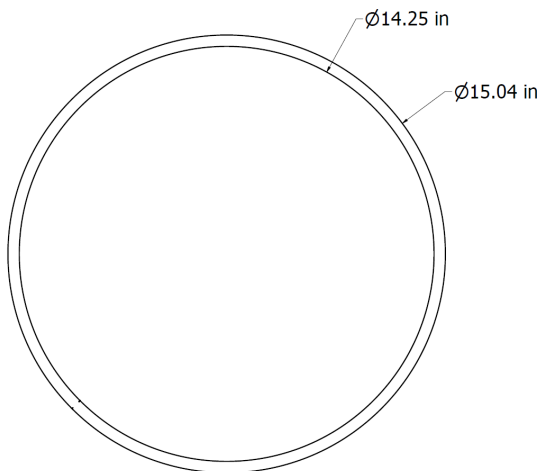

## DIMENSIONS - MOUNTING

### SCREW POSITION FOR SURFACE MOUNT

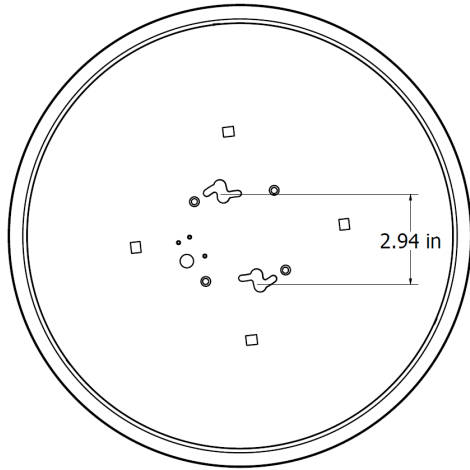

### STEM

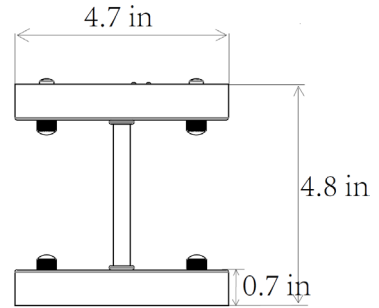

## LUMEN ESTIMATE

Lumen output varies based on CCT and CRI. An estimate of lumen output of the various CCT/CRI combinations, use correction factors as per table below:

### LUMEN ESTIMATE ADJUSTMENT FACTORS

CCT	3500K	4000K	5000K
PREMIUM (90CRI)	0.97	1	1.03

## PHOTOMETRIC DATA

PART NUMBER		ZONAL LUMEN SUMMARY			POLAR LUMINOUS INTENSITY	CONE DISTRIBUTION		
CS-EC-15-24W		Zone	Lumens	% Fixture	Direct Light	Center Beam Fc	Beam Width	
Wattage	22W	0-20°	132.10	7.2		57 fc	5.0 ft	7.3 ft
CCT	5000K	0-30°	285.38	15.5		14.3 fc	10.0 ft	14.7 ft
Distribution	120°	0-40°	479.27	26.1		6.34 fc	15.0 ft	22.0 ft
Diameter	15"	0-60°	916.39	49.8		3.56 fc	20.0 ft	29.3 ft
		0-80°	1304.58	71.1		2.28 fc	25.0 ft	36.7 ft
		0-90°	1455.33	79.2	1.58 fc	30.0 ft	44.0 ft	

#### OVERVIEW



#### Innovative Design

- Round decorative downlight.
- Highly durable polycarbonate and high transmittance lens.



#### Options

- 15-inch diameter
- Five CCT switchable
- Matte black cover & brushed Brass reflector

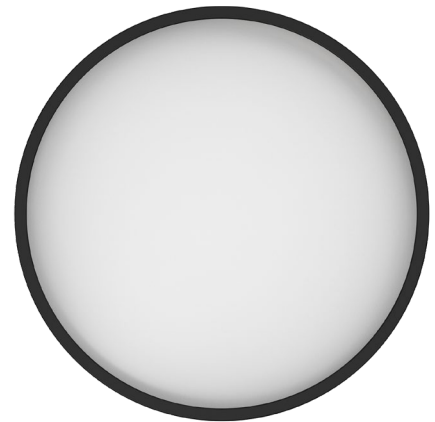

#### Tests And Certifications



#### Mounting Available

- Surface mount
- Stem mount

#### DIMMER COMPATIBILITY LIST

TRIAC Dimming

Model
Lutron CTCL-153P
Lutron DVCL-253P
Lutron S-603P
Lutron DV-603PG
Lutron S-603PG

