

TRACK T2

TRACK ACCESSORIES AND SYSTEMS

ERALUX Track 2 is compatible with Juno two circuit Adapters (Juno is a brand of ACUITY). Track and power distribution system is suitable for retail, commercial and residential use. Ships with one end cap (T0009) installed extruded aluminum "I" beam. Thermoplastic insulator. Two #12 AWG solid copper conductors.

eralux®

	DATE	QTY	ACC. QTY	TYPE
PROJECT				
PN				
ACCESSORY PN				
NOTES				



PRODUCT CERTIFICATIONS



SYSTEM WARRANTY – 3 YEARS

Eralux will warrant defective drivers, LEDs and boards for 3 years from the date of purchase. This warranty is valid only if the fixture is installed and used as per installation guides and specifications. If a defect is present, Eralux will send drivers and boards at no fee with a thorough replacement instructions along with instructions on the return of the defective parts back to Eralux.

ORDERING GUIDE



T2-
ERALUX T2 two circuit Juno compatible track system

2
2' Track system
4
4' Track system
6
6' Track system
8
8' Track system

-WHT
White finish
-BLK
Black finish
-SLV
Silver finish

Fixture Family







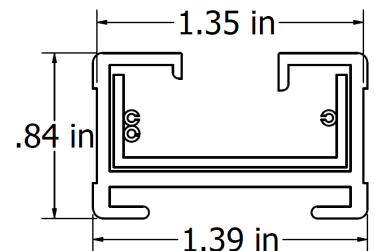



Length

Finish

PART NO.	LENGTH	LENGTH
T2-2	2'	512 mm (20.16")
T2-4	4'	1122 mm (44.17")
T2-6	6'	1732 mm (68.19")
T2-8	8'	2341 mm (92.17")



ACCESSORIES

ORDERING CODE		DESCRIPTION	PICTURE
T20001	-WHT	Mini I Connector	
	-BLK		
	-SLV		
T20002	-WHT	T Connector	
T20002R (Reverse)	-BLK		
	-SLV		
T20003	-WHT	L Connector	
	-BLK		
	-SLV		
T20004	-WHT	X Connector	
	-BLK		
	-SLV		
T20005	-WHT	Floating Canopy	
	-BLK		
	-SLV		
T20006	-WHT	Conduit End Feed	
T20006R (Reverse)	-BLK		
	-SLV		
T20007	-WHT	Flexible Connector	
	-BLK		
	-SLV		
T20008	-WHT	End Feed Kit and Cover	
	-BLK		
	-SLV		
T20009	-WHT	End Cap	
	-BLK		
	-SLV		
T20012	-WHT	T-Bar Connector	
	-BLK		
	-SLV		
T20013	-WHT	T-Bar End Feed	
	-BLK		
	-SLV		

ACCESSORIES

ORDERING CODE		DESCRIPTION	PICTURE
T20015	-WHT	Top Access End Feed	
	-BLK		
T20015 (Reverse)	-SLV		
T20021	-WHT	Two Circuit End Feed	
	-BLK		
	-SLV		
T20022	-WHT	Two Circuit End Feed and 1' Track Attached	
	-BLK		
	-SLV		
T20023	-WHT	Two Circuit In-Line Feed	
	-BLK		
	-SLV		
T20024	-WHT	Two Circuit In-Line Feed ad 1' Track Attached	
	-BLK		
	-SLV		
T10020	-WHT	Cover Plate	
	-BLK		
	-SLV		
T10027	-WHT	Suspension Canopy	
	-BLK		
	-SLV		
T10028	-WHT	Swivel Stem Kit For Sloped Ceiling	
	-BLK		
	-SLV		
T10029	-WHT	Suspension Stem Coupling	
	-BLK		
	-SLV		
T10030	-WHT	Wireway Cover For Suspension	
	-BLK		
	-SLV		

ACCESSORIES

ORDERING CODE		DESCRIPTION	PICTURE
TS48	-WHT	48" Stem	
	-BLK		
TS36	-WHT	36" Stem	
	-BLK		
TS24	-WHT	24" Stem	
	-BLK		
TS12	-WHT	12" Stem	
	-BLK		
TS6	-WHT	6" Stem	
	-BLK		

MINI I CONNECTOR

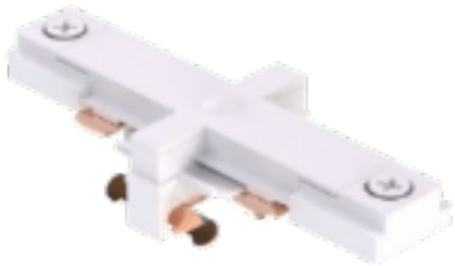

COLOUR	ORDERING CODE
White	T20001-WHT
Black	T20001-BLK
Silver	T20001-SLV

DIMENSIONS (in mm)

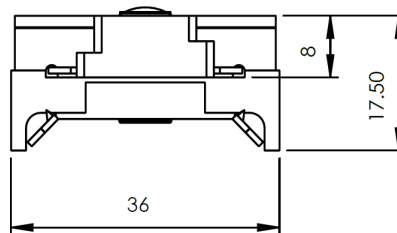
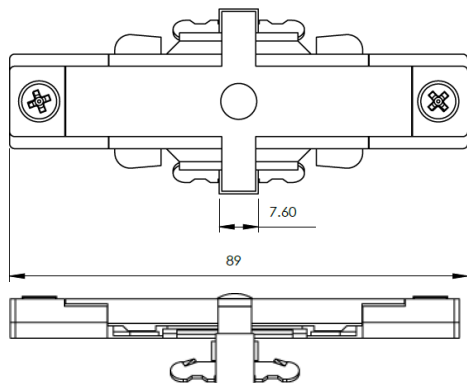

T CONNECTOR

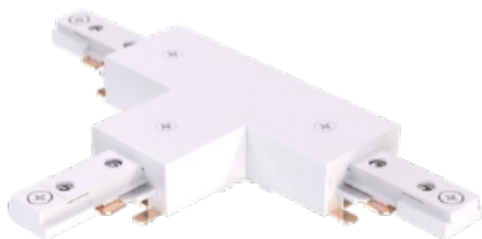

T Connector

COLOUR	ORDERING CODE
White	T20002-WHT
Black	T20002-BLK
Silver	T20002-SLV

DIMENSIONS (in mm)

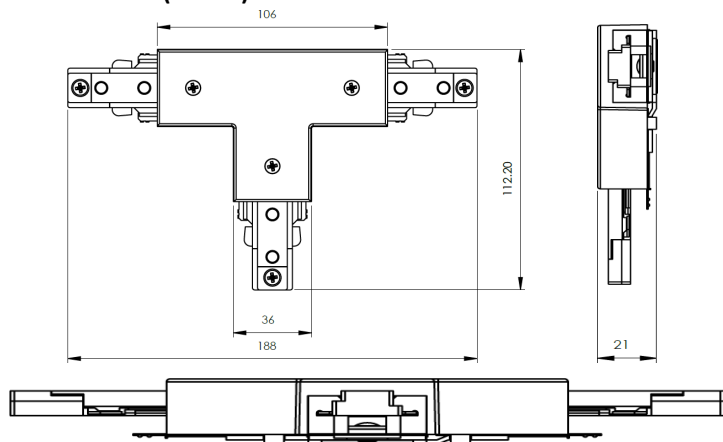

T Connector Reverse

COLOUR	ORDERING CODE
White	T20002R-WHT
Black	T20002R-BLK
Silver	T20002R-SLV

L CONNECTOR



DIMENSIONS (in mm)

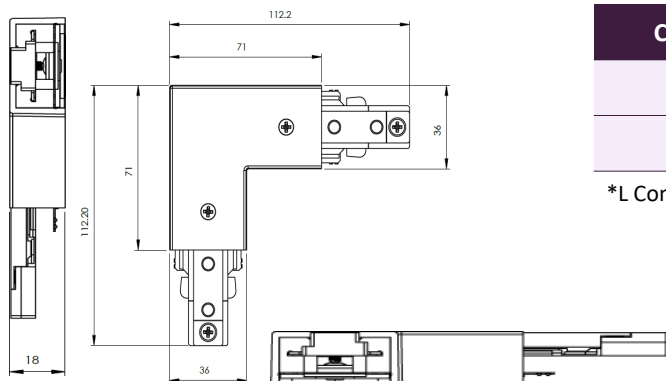

L Connector

COLOUR	ORDERING CODE
White	T20003-WHT
Black	T20003-BLK
Silver	T20003-SLV

L Connector Cover

COLOUR	ORDERING CODE
White	AE-TS-LCONNECTOR-COVER-WH
Black	AE-TS-LCONNECTOR-COVER-BK

*L Connector + Cover → Straight Connector + Power Feed

X CONNECTOR

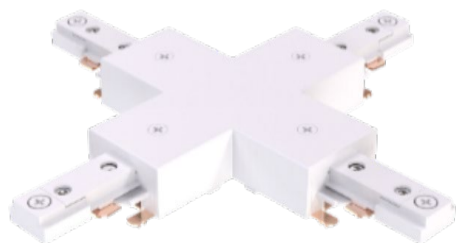

DIMENSIONS (in mm)

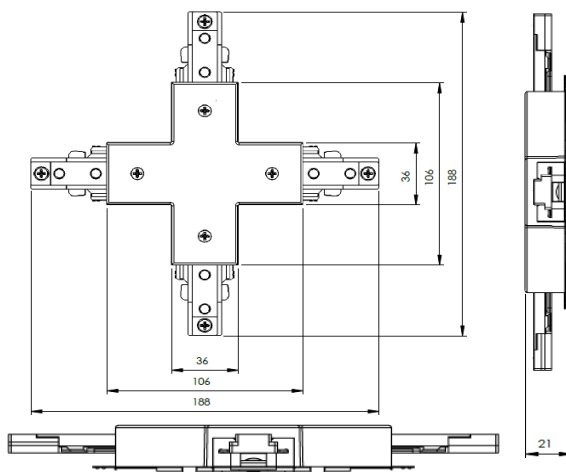

COLOUR	ORDERING CODE
White	T20004-WHT
Black	T20004-BLK
Silver	T20004-SLV

FLOATING CANOPY



DIMENSIONS (in mm)

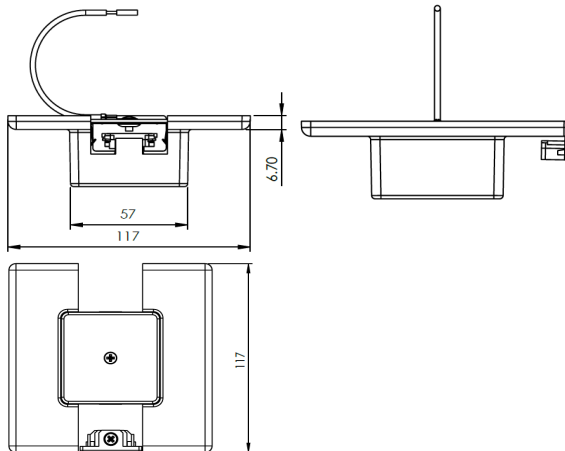

COLOUR	ORDERING CODE
White	T20005-WHT
Black	T20005-BLK
Silver	T20005-SLV

CONDUIT END FEED



DIMENSIONS (in mm)

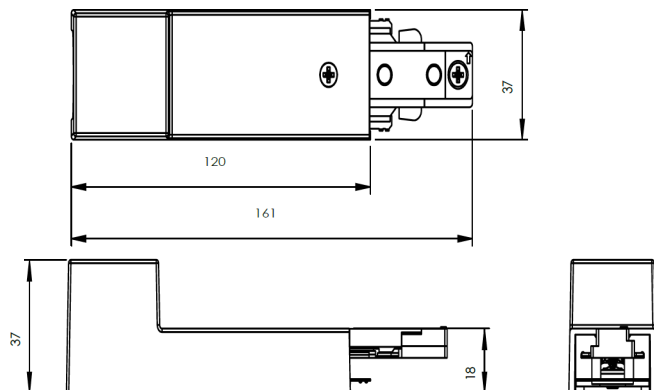

Conduit End Feed

COLOUR	ORDERING CODE
White	T20006-WHT
Black	T20006-BLK
Silver	T20006-SLV

Conduit End Feed Reverse

COLOUR	ORDERING CODE
White	T20006R-WHT
Black	T20006R-BLK
Silver	T20006R-SLV

TRACK SYSTEM AND ACCESSORIES

Track Components

FLEXIBLE CONNECTOR



COLOUR	ORDERING CODE
White	T20007-WHT
Black	T20007-BLK
Silver	T20007-SLV

DIMENSIONS (in mm)

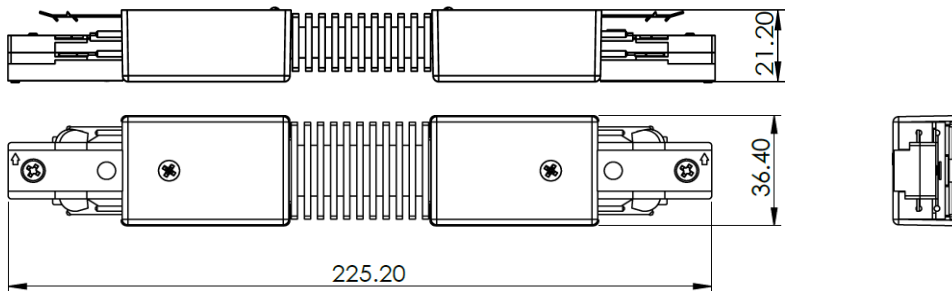

END FEED KIT AND COVER



COLOUR	ORDERING CODE
White	T20008-WHT
Black	T20008-BLK
Silver	T20008-SLV

DIMENSIONS (in mm)

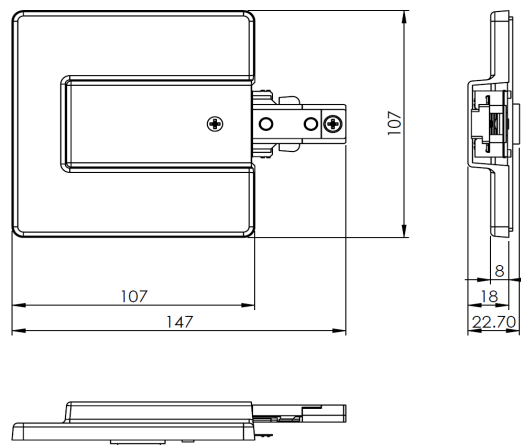

TRACK SYSTEM AND ACCESSORIES

Track Components

T-BAR CONNECTOR

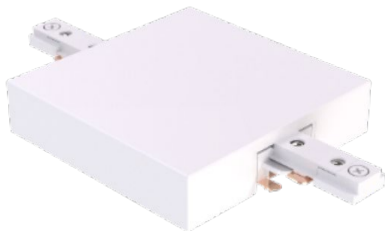

COLOUR	ORDERING CODE
White	T20012-WHT
Black	T20012-BLK
Silver	T20012-SLV

DIMENSIONS (in mm)

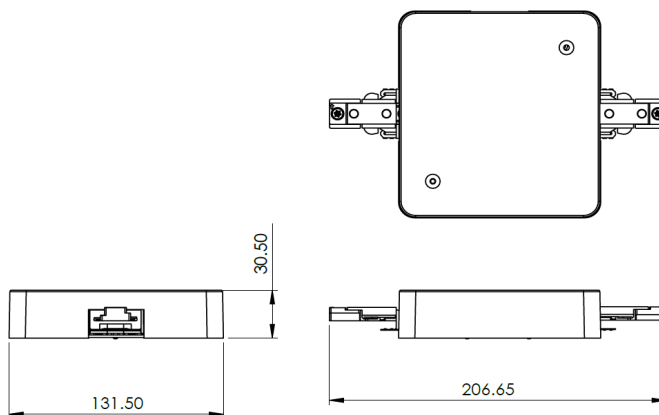

T-BAR END FEED



COLOUR	ORDERING CODE
White	T20013-WHT
Black	T20013-BLK
Silver	T20013-SLV

DIMENSIONS (in mm)

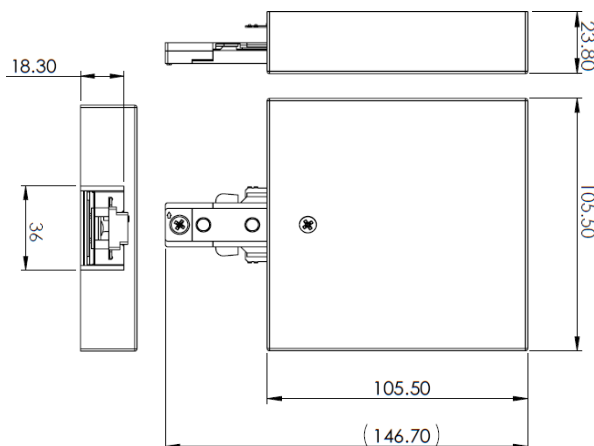

TRACK SYSTEM AND ACCESSORIES

Track Components

TOP ACCESS END FEED



DIMENSIONS (in mm)

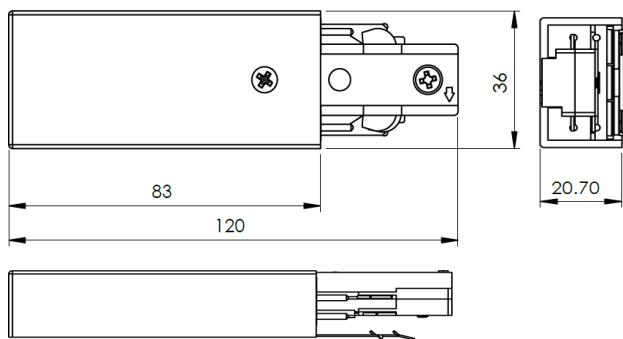

Top Access End Feed

COLOUR	ORDERING CODE
White	T20015-WHT
Black	T20015-BLK
Silver	T20015-SLV

Top Access End Feed Reverse

COLOUR	ORDERING CODE
White	T20015R-WHT
Black	T20015R-BLK
Silver	T20015R-SLV

SINGLE CIRCUIT END FEED



DIMENSIONS (in mm)

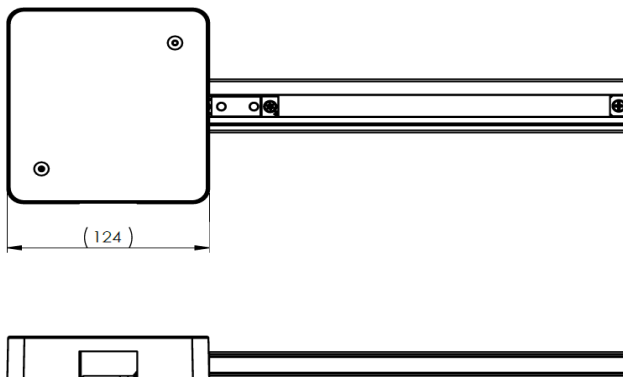

COLOUR	ORDERING CODE
White	T20021-WHT
Black	T20021-BLK
Silver	T20021-SLV

TRACK SYSTEM AND ACCESSORIES

Track Components

SINGLE CIRCUIT IN-LINE FEED



COLOUR	ORDERING CODE
White	T20023-WHT
Black	T20023-BLK
Silver	T20023-SLV

DIMENSIONS (in mm)

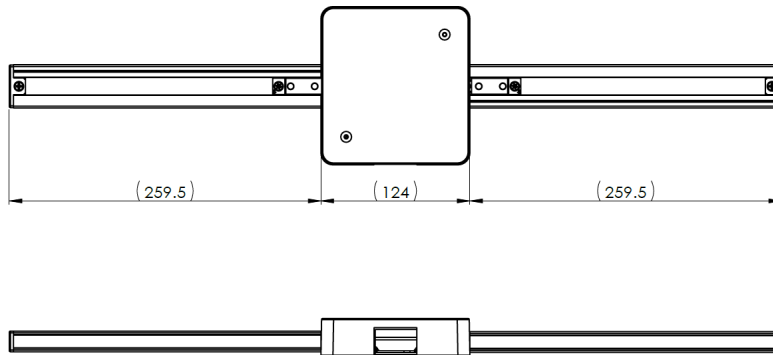
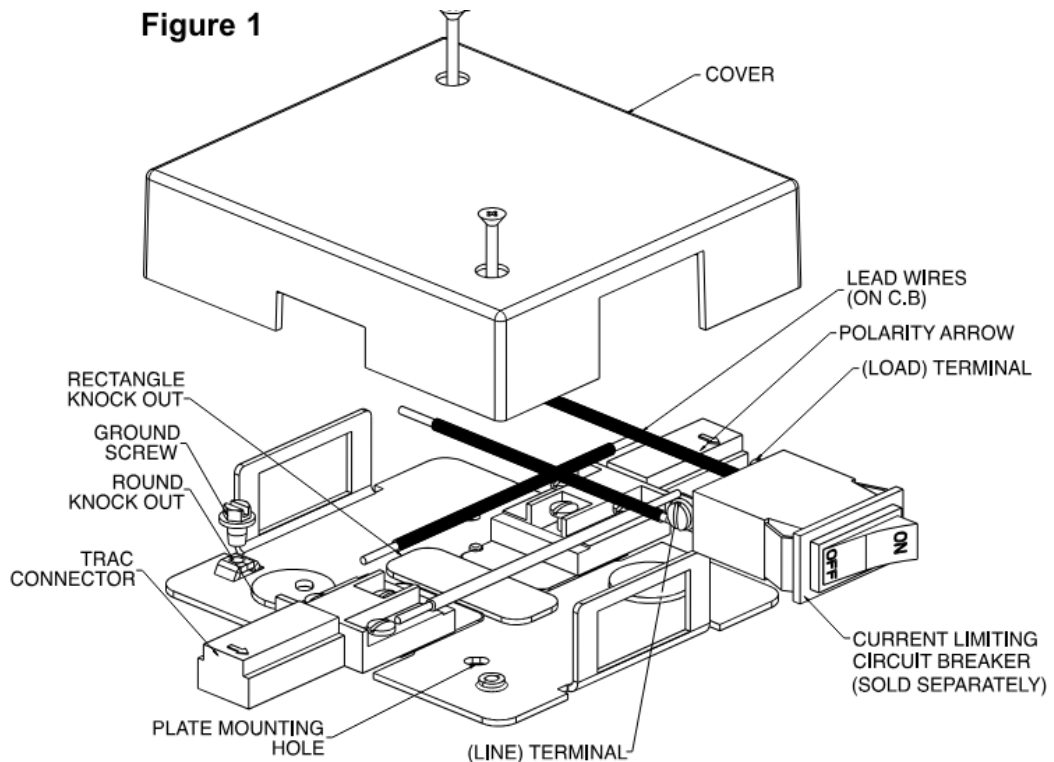

Figure 1



TRACK SYSTEM AND ACCESSORIES

Track Suspension

SUSPENSION TRACK WIRES

Whether using a cable coupler or a looped cable method, these suspension track wires are designed to suspend track systems from the ceilings. These kits comes in two assemblies of 150 inches cables, grippers, and 8-32 bolts.

ORDERING GUIDE

G-16TRK-SR-		
G-16TRK-SR- 1/16" galv. cable, gripper, and 8-32 bolt	44 Looped cable CC Cable Coupler	-150 150 inches length suspension wire
Family	Suspension Type	Wire Length

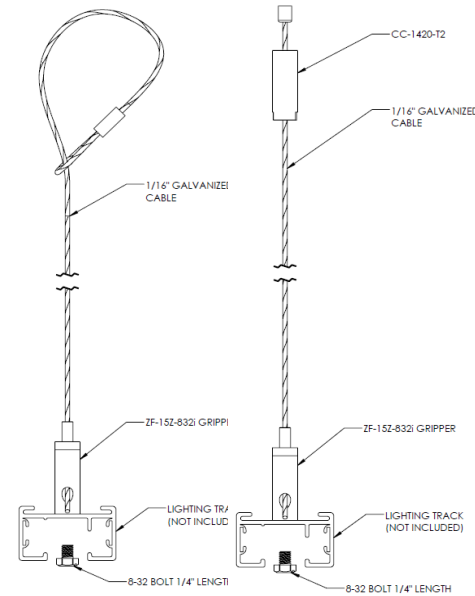

SUSPENSION TRACK BRACKET

This suspension track bracket are designed to suspend track systems from the ceilings.

COMPATIBLE MOUNTING

Mounting	For suspended track systems
Eralux Track Systems	T1 T2

ORDERING GUIDE

AE-TS-SUS-KIT-TRK		
AE-TS-SUS-KIT-TRK Suspension bracket for suspending tracks Two suspension brackets, 20FT galvanized cable, gripper, and one screw	-BLK Black finish bracket -WHT White finish bracket	BLANK Suspension ceiling mount bracket -HOLDER Holder
Fixture Family	Finish	Holder

AE-TS-SUS-KIT-TRK-BLK

AE-TS-SUS-KIT-TRK-BLK-HOLDER



Holder

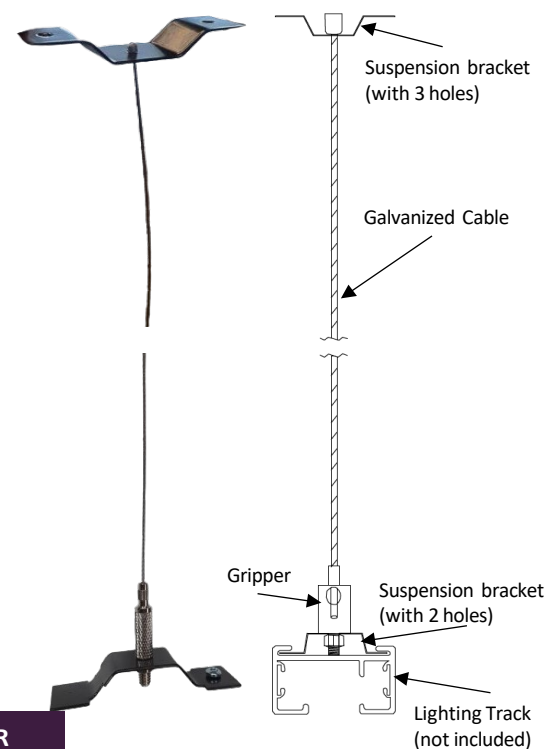

TRACKHEAD EXTENSION WAND



COLOUR	LENGTH	ORDERING CODE
White	12"	T1-Extwand-12"-WHT
	18"	T1-Extwand-18"-WHT
	24"	T1-Extwand-24"-WHT
	36"	T1-Extwand-36"-WHT
	48"	T1-Extwand-48"-WHT
Black	12"	T1-Extwand-12"-BLK
	18"	T1-Extwand-18"-BLK
	24"	T1-Extwand-24"-BLK
	36"	T1-Extwand-36"-BLK
	48"	T1-Extwand-48"-BLK

TRACK SYSTEM AND ACCESSORIES

Track Accessories

STEM KIT FOR SUSPENSION

CANOPY



COLOUR	ORDERING CODE
White	T10027-WHT
Black	T10027-BLK

STEM



COLOUR	LENGTH	ORDERING CODE
White	48"	TS48-WHT
	36"	TS36-WHT
	24"	TS24-WHT
	12"	TS12-WHT
Black	48"	TS48-BLK
	36"	TS36-BLK
	24"	TS24-BLK
	12"	TS12-BLK

*Each product is ordered separately

TRACK ACCESSORIES AND CONNECTIONS

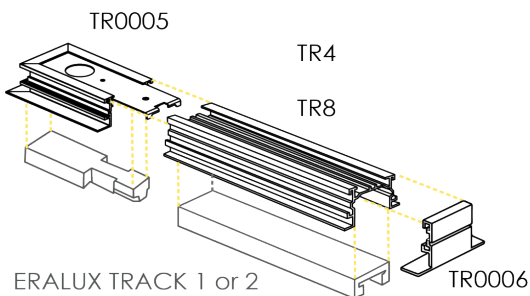

TR-		
TR- ERALUX TR reversed circuit Juno compatible track systems	4 4' Track system 8 8' Track system 12 12' Track system	-WHT White finish -BLK Black finish -SLV Silver finish
Family	Length	Finish

TRACK COMPONENTS

RECESSED HOUSING FOR I CONNECTOR



COLOUR	ORDERING CODE
White	TR0001-WHT
Black	TR0001-BLK
Silver	TR0001-SLV

RECESSED HOUSING FOR T CONNECTOR



COLOUR	ORDERING CODE
White	TR0002-WHT
Black	TR0002-BLK
Silver	TR0002-SLV

RECESSED HOUSING FOR L CONNECTOR

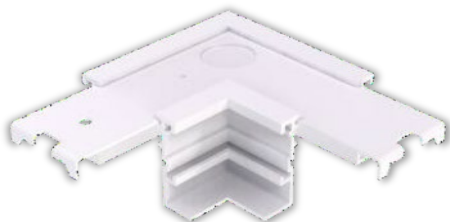

COLOUR	ORDERING CODE
White	TR0003-WHT
Black	TR0003-BLK
Silver	TR0003-SLV

RECESSED HOUSING FOR END FEED



COLOUR	ORDERING CODE
White	TR0005-WHT
Black	TR0005-BLK
Silver	TR0005-SLV

RECESSED HOUSING FOR END PIECE



COLOUR	ORDERING CODE
White	TR0006-WHT
Black	TR0006-BLK
Silver	TR0006-SLV