

Commercial LED Lighting

Tri-Lens Troffer | 2x2 & 2x4

Everest is a tri-lens architectural troffer that offers superior lighting for your application. Available in two sizes: 2x2' and 2x4' with switchable CCT and power options. It provides flexibility in terms of brightness and color temperature for any installation, with efficacy up to 140 LPW.

Applications: Commercial Office Spaces | Healthcare | Schools | Retail Merchandising Areas.

	DATE	QTY	ACC. QTY	TYPE
PROJECT				
PN				
ACCESSORY PN				
NOTES				



DYNAMIC MENU

Ordering Guide	Page 2
Dimensions	Page 3
Control	Page 5
Photometric Data	Page 8

[Install Instructions](#)

SPECIFICATIONS

Input Voltage	120-277/347V	
Power Factor	>0.9	
Total Harmonic Distortion	<20%	
Dimming	0-10V Dimming	
CRI	80 CRI	
CCT	27K 30K 35K 40K 50K	
Lumens Per Watt	~140LPW	
Power	2X2'	30/25/18/15W
	2X4'	41/34/28/20W
Ambient Temperature Range	-20°C to 50°C	
Distribution	120°	
Mounting options <small>page 5</small>	Surface Mount Suspended Recessed- Gypsum Recessed -T grid	
Material	Aluminium Frame Metal Housing	
Lens	Optical Polystyrene	



PRODUCT FEATURES



PRODUCT CERTIFICATIONS



SYSTEM WARRANTY – 5 YEARS

Eralux will warrant defective drivers, LEDs and boards for 5 years from the date of purchase. This warranty is valid only if the fixture is installed and used as per installation guides and specifications. If a defect is present, Eralux will send drivers and boards at no fee with a thorough replacement instructions along with instructions on the return of the defective parts back to Eralux.

LUMEN MAINTENANCE – L70 at 100,000 hours

Rated for 70% initial lumen output at 100,000 hours of operation, operated at 25°C ambient temperature; per guidelines published by the Illuminating Engineering Society (IES).



ORDERING GUIDE

RC-EV		-CA	-S	-TCP	
RC-EV ERALUX Everest Tri-Lens Panel	-2X2-30W 2x2' 30/25/18/15W 4,200/3,500/2,500/2,100lm	-CA 120-277/347V	-S 120°	-TCP 2700/3000/3500/ 4000/5000K selectable	[BLANK] No Option -MS Bi-Level PIR Motion Sensor IFS06R
	-2X4-41W 2x4' 41/34/28/20W 5,800/4,800/4,000/2,800lm				

Fixture Family	Size	Input Voltage	Distribution	CCT	Controls
----------------	------	---------------	--------------	-----	----------

NOTES 1. 8W battery: 90 minutes available for all sizes.



ORDERING GUIDE - ACCESSORIES

AE-RC-M ERALUX Commercial Mounting Options	BGYPK Gypsum Kit SMK- Surface Mount Kit-3" thickness	2X2 2x2' 2X4 2x4'

Fixture Family	Mounting Option	Size
----------------	-----------------	------

AE-RC-MB ERALUX Commercial Mounting Options	-HK¹ Hanging Kit

[BLANK] No EMBB BLD-HM8D-YYY 8W emergency battery backup

Fixture Family	Mounting Option
----------------	-----------------

EMBB

NOTES 1. For more aesthetic look suspension and surface mount kit can be ordered together.

DIMENSIONS

TOP VIEW EVEREST-STANDARD

THICKNESS

RC-EV-2X2

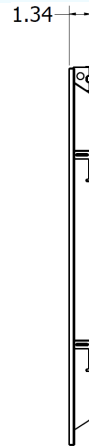
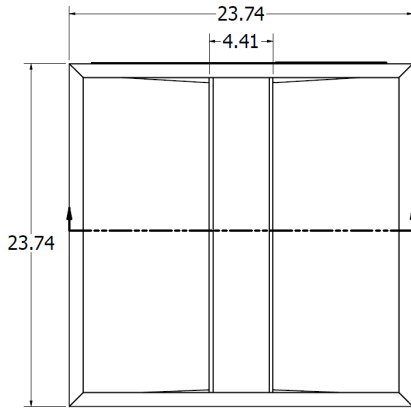

RC-EV-2X4

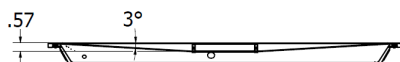
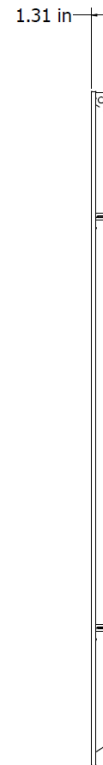
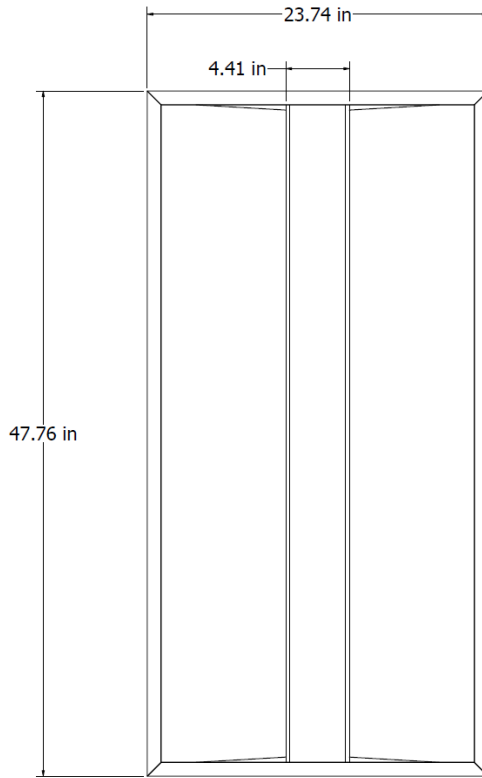

MOUNTING ACCESSORIES

Ordered separately, field installed

GYPSUM KIT

Recessed Gypsum



ORDERING CODE	DIMENSIONS		
	LENGTH	WIDTH	HEIGHT
AE-RC-MBGYPK2X2	25.1"	25.1"	1.5"
AE-RC-MBGYPK2X4	49.1"	13.3"	1.5"

SURFACE MOUNT KIT

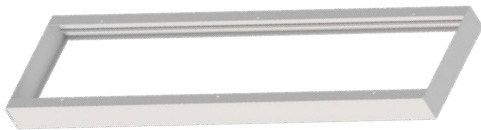

	ORDERING CODE	DIMENSIONS		
		LENGTH	WIDTH	HEIGHT
3" - thickness	AE-RC-MSMK-2X2	24"	24"	2.91"
	AE-RC-MSMK-2X4	48"	12.2"	2.91"

SUSEPENSION KIT



ORDERING CODE	QUANTITY	DESCRIPTION	LENGTH
AE-RC-MB-HK	3 pieces/set	Galvanized aircraft cable	4'

CONTROLS

Bi-Level PIR Motion Sensor - IFS06R



SPECIFICATIONS	
Input Voltage	12V DC
IP Rated	IP20
Mounting Height	23 Feet max
	7 Meters
Detection Range	10 Meters
	32 Feet
Standby Power	<0.5W
Operating Temperature	-30°C to 55°C
Installation	Fixture integrated

The IFS06R is a compact PIR (Passive Infrared) sensor that combines motion detection with daylight control. It works with 0-10V dimming LED drivers to enable automatic lighting, turning fixtures on and off based on occupancy and available daylight. The built-in photocell allows for dusk-to-dawn operation, keeping lights on overnight even without motion. In daylight harvesting mode, it automatically adjusts lighting to maintain the perfect balance with natural light. It's ideal for low-profile fixtures and supports simple push-button connections.

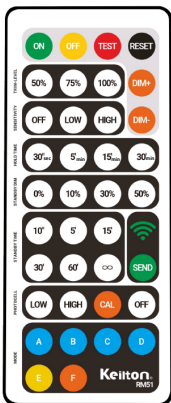
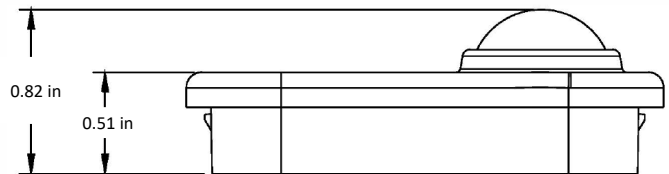
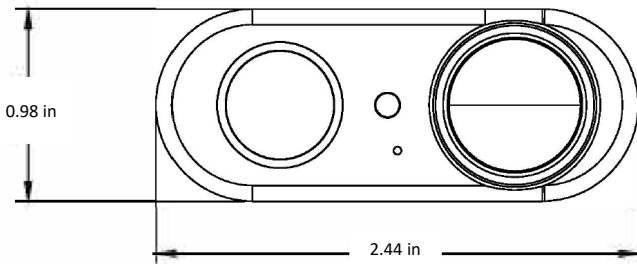

Remote control:

AE-SF-JB-MOTIONSENSOR-RMT

Comes with 6 default modes with different options:

- Trim-level (Dimming % when turned on)
- Sensitivity (Sensor sensitivity to movement)
- Hold time (Time before the fixture goes to standby mode)
- Standby dim percentage (Dimming % when no movement)
- Standby time (Time before the fixture turns off after standby)
- Photocell (Sensitivity for the lumens adjustment to natural light)

Microwave motion sensor coverage

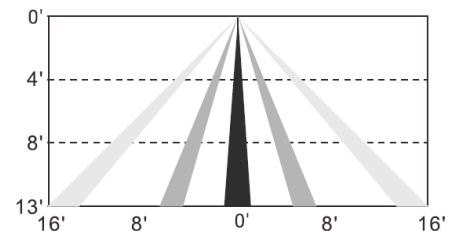

CONTROLS

ARIA PLUS - Low Bay Sensor Bluetooth Control System – Refer to Aria spec sheet for more details

IFS108



This sensor extend the capabilities of a host controller device by providing PIR detection with adjustable sensitivity inputs.

Parameters	
Input Voltage	12V
Input Power	0.3W
Application	Indoor
Detection Range	40ft
Mounting Height	18ft
Operating Temperature	-30°C to 55°C
IP Rating	IP20
Installation	Integrated
Detection	PIR

Features
PIR occupancy sensor
Supports setting a delay time and bi-level dimming
Sensitivity adjustment from 0-100%
Designed for low bay application
Daylight harvesting available

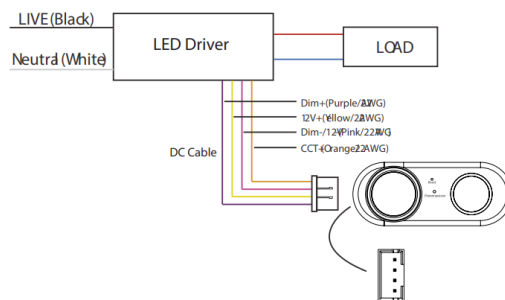
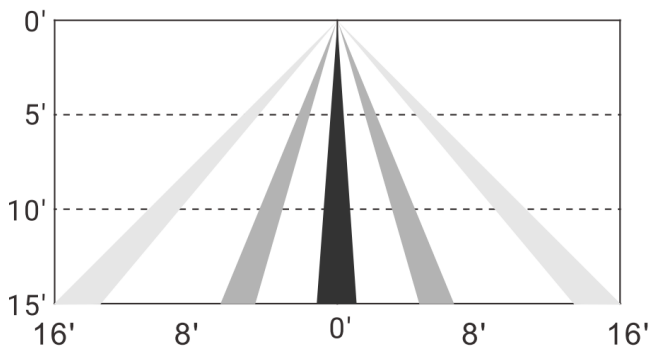

CONTROLS

EMERGENCY BATTERY BACK UP

BLD-HM8D-YYY



The BLD-HMXXD-YYY series LED Emergency Driver is UL listed for field and factory installations. It switches to emergency mode during power failures, providing up to 90 minutes of lighting. With an integrated battery, charger, and converter, it delivers 6-25W constant power at 170VDC. Ideal for 0-10V dimmable indoor commercial LED fixtures, such as flat panels, troffers, downlights, and linear strip lights.

SPECIFICATIONS	
Input Voltage	100-347 Vac
Power Frequency	50/60HZ
Input Power	8W max
Output Voltage	170V Dc
Output Power	8W
Ambient Temperature	0°C to 50°C
	30°F to 122°F
Installation	Remote

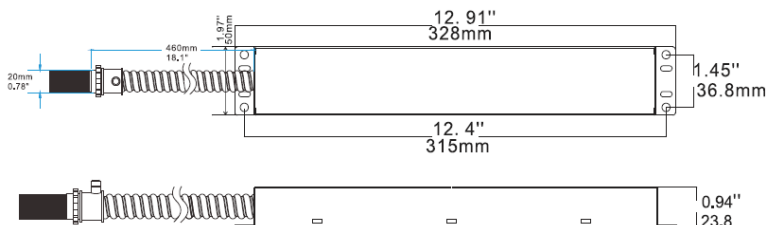

ROOM OCCUPANCY SENSOR

Ordered separately, field installed

PART NUMBER	DESCRIPTION
AE-CT-DT806	Detecta - Room Occupancy Sensor
RC102	RC102 Remote Control

SPECIFICATIONS		
Input Voltage	120-277 Vac	
Power Frequency	50/60HZ	
Rated Load	At 120 Vac	800W
	At 277 Vac	1200W
Detection Range	3-10 Meters	
	9.8- 32.8 Feet	
Standby Power	~0.9W	
Time Setting	10 sec to 30 min	
Light Control	10-2,000LUX	
Installation	Ceiling Mounted	

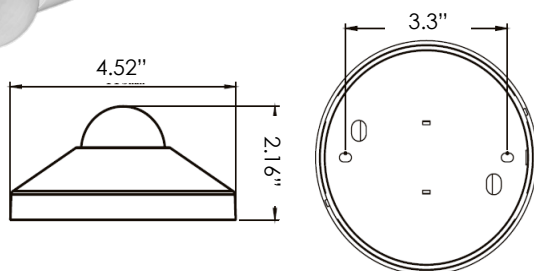

LUMEN ESTIMATE

Lumen output varies based on CCT and CRI. An estimate of lumen output of the various CCT/CRI combinations, use correction factors as per table below:

LUMEN ESTIMATE ADJUSTMENT FACTORS			
CCT	3500K	4000K	5000K
80CRI	0.97	1.00	1.03

PHOTOMETRIC DATA

PART NUMBER		ZONAL LUMEN SUMMARY			POLAR LUMINOUS INTENSITY		CONE DISTRIBUTION		
RC-EV-2X2-30W-CA		Zone	Lumens	% Fixture	Direct Light		Center Beam fc		Beam Width
Wattage	30W	0-20°	532.63	12.6		2.5ft	233 fc	7.7 ft	7.5 ft
CCT	3000K	0-30°	1132.24	26.8		5.0ft	58.2 fc	15.4 ft	15.0 ft
Distribution	120°	0-40°	1857.50	44.0		7.5ft	25.9 fc	23.1 ft	22.5 ft
		0-60°	3295.09	78.1		10.0ft	14.6 fc	30.8 ft	30.1 ft
		0-80°	4126.14	97.8		12.5ft	9.31 fc	38.5 ft	37.6 ft
		0-90°	4215.70	99.9		15.0ft	6.47 fc	46.2 ft	45.1 ft
					■ Vert. Spread: 114.1° ■ Horiz. Spread: 112.7°				

PART NUMBER		ZONAL LUMEN SUMMARY			POLAR LUMINOUS INTENSITY		CONE DISTRIBUTION		
RC-EV-2X4-41W-CA		Zone	Lumens	% Fixture	Direct Light		Center Beam fc		Beam Width
Wattage	41W	0-20°	727.75	12.6		2.5ft	318 fc	7.8 ft	7.5 ft
CCT	3000K	0-30°	1548.19	26.8		5.0ft	79.5 fc	15.6 ft	15.0 ft
Distribution	120°	0-40°	2541.43	43.9		7.5ft	35.3 fc	23.5 ft	22.5 ft
		0-60°	4515.16	78.1		10.0ft	19.9 fc	31.3 ft	30.0 ft
		0-80°	5658.08	97.8		12.5ft	12.7 fc	39.1 ft	37.5 ft
		0-90°	5781.25	100		15.0ft	8.83 fc	46.9 ft	45.0 ft
					■ Vert. Spread: 114.8° ■ Horiz. Spread: 112.6°				



Everest

DLC MODEL	PRODUCT ID	Primary Use	Classification
RC-EV-2X2-30W-CA-S-TCP-(Blank, EM, MS)	S-KZJ1Z3	2X2 Luminaires for Ambient Lighting of Interior Commercial Spaces	Premium
RC-EV-2X4-41W-CA-S-TCP-(Blank, EM, MS)	S-WZC4QV	Low-Bay Luminaires for Commercial and Industrial Buildings	Premium

OVERVIEW



Innovative Design

- Aluminum Frame
- Enhanced quality diffuser ensures high efficiency light output for a clean, evenly illuminated surface
- Matte white finish



Multiple Selections

- 2x2', and 2x4' sizes.
- Power Switchable.
- Five CCT Switchable available.

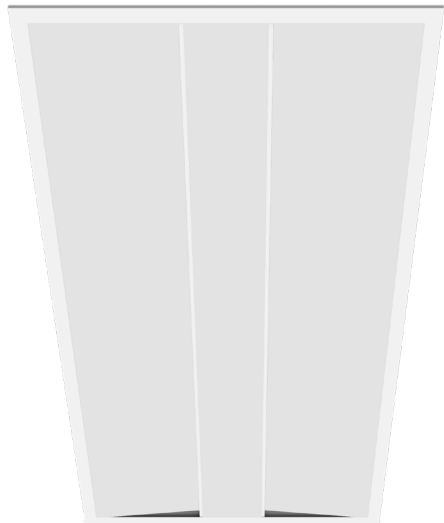
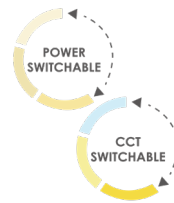

Accessories

- Motion sensor
- 8W Emergency backup



Emergency backup battery



Motion Sensor



Mounting Options

- Surface Mount
- Gypsum
- Suspended
- Suspended with surface mount kit
- Recessed -T grid

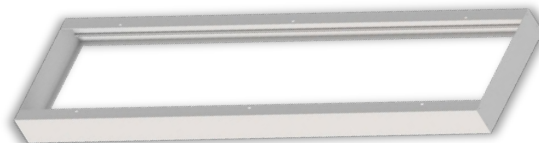

Tests And Certifications

