

LINEAR LED LIGHT

Suspended Architectural Linear | 2.5" Aperture | Direct

The G5 is a linear architectural LED fixture designed to deliver direct lighting for a seamless ambiance. Featuring a selection of diffuser options including parabolic louver, drop lens, and wall wash. Our linear supports continuous runs, creating a unified lighting design that enhances the aesthetic of any environment. Custom designs are achievable for straight runs, as well as X-T-L shapes and honey-comb designs.

Applications: Art Galleries | Office | Retail Stores | Hospitality | Education

	DATE	QTY	ACC. QTY	TYPE
PROJECT				
PN				
ACCESSORY PN				
NOTES				

DYNAMIC MENU	
Order Information	Page 2
Dimensions	Page 5
Accessories	Page 7
Photometric Data	Page 12

[Install Instruction Link](#)

SPECIFICATIONS

Input Voltage	120-277/347V	
Power Factor	>0.9	
Total Harmonic Distortion	<20%	
Dimming Page 4	0-10V dimming	
CRI	80 CRI	
CCT	<div style="display: flex; gap: 10px;"> <div style="border: 1px solid black; border-radius: 50%; width: 20px; height: 20px; background-color: #fff9c4; display: flex; align-items: center; justify-content: center;">30K</div> <div style="border: 1px solid black; border-radius: 50%; width: 20px; height: 20px; background-color: #e1f5fe; display: flex; align-items: center; justify-content: center;">35K</div> <div style="border: 1px solid black; border-radius: 50%; width: 20px; height: 20px; background-color: #e1f5fe; display: flex; align-items: center; justify-content: center;">40K</div> <div style="border: 1px solid black; border-radius: 50%; width: 20px; height: 20px; background-color: #e1f5fe; display: flex; align-items: center; justify-content: center;">50K</div> </div>	
Efficacy	~110 LPW	~1100 lm/ft
Length	2ft 3ft 4ft 5ft 6ft 8ft	
Power	20W 30W 40W 50W 60W 80W	
Ambient Temperature Range	-10°C to 40°C	
Mounting Options		
Fixture Finish	Black White Silver Gun powder Maple 	
Acoustic Panel Finish Page 9	BBQ Sauce Soya Sauce Tilapia 	
Custom Design Page 3	X, L, T shapes Continuous runs Hexagon Shapes	
Optics Page 10	Polycarbonate Drop lens Wall Wash Parabolic louver	
Distribution		

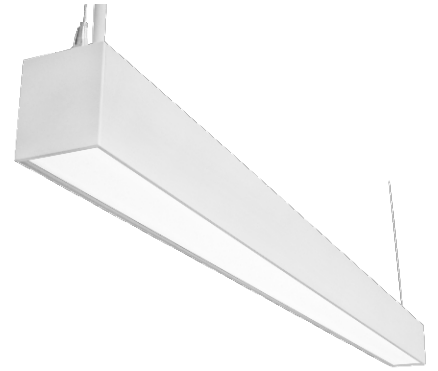

PRODUCT FEATURES



PRODUCT CERTIFICATIONS



Design Lights Consortium® (DLC) qualified product. Not all versions of this product may be DLC qualified. Please check the DLC Qualified Products List at www.designlights.org/QPL to confirm which versions are qualified" [page 4](#)

SYSTEM WARRANTY – 5 YEARS

Eralux will warrant defective drivers, LEDs and boards for 5 years from the date of purchase. This warranty is valid only if the fixture is installed and used as per installation guides and specifications. If a defect is present, Eralux will send drivers and boards at no fee with a thorough replacement instructions along with instructions on the return of the defective parts back to Eralux.

LUMEN MAINTENANCE – L85 at 50,000 hours

Rated for 85% initial lumen output at 50,000 hours of operation, operated at 25°C ambient temperature; per guidelines published by the Illuminating Engineering Society (IES).

LINEAR LED LIGHT

Suspended Architectural Linear | 2.5" Aperture | Direct



ORDERING GUIDE

AE-SF-G5CA			010	
AE-SF-G5CA ERALUX G5 Suspended Architectural Linear 120-277/347V Input Voltage	2 20 2ft 20W 2100 lm 3 30 3ft 30W 3150 lm 4 40 4ft 40W 4400 lm 5 50 5ft 50W 5500lm 6 60 6ft 60W 6600lm 8 80 8ft 80W 8800lm C Continuous length increment of 1ft (Select or type the length then click on 'C')	30/35/40¹ 3000/3500/4000K Selectable 30/40/50 3000/4000/5000K Selectable	010 0-10V Dimming	WH-GB White BK-GB Black SV-GB² Silver GN-GB² Gun Powder MA-GB³ Maple

Fixture Family	Length Power	CCT	Control	Finish
[BLANK] No option -LDE1⁴ Fade-to-Black down to 1% -EMBB⁵ Emergency Battery Backup -1DIM⁶ 1% Dimming	-PU -PU18 -PH -PH18	[BLANK] No Canopy -C	[BLANK] -W18	[BLANK] Standard polycarbonate -P Prime Parabolic silver -PS Prime Shadow Parabolic Black -DL 0.5" Drop -WW Wall Wash
Option	Power Cord	Canopy	Aircraft Cable	Diffuser

REFER BELOW FOR DETAILED DESCRIPTION OF SUSPENSION KITS

-PU	8ft power cord 120-277V 8ft aircraft cable ⁷
-PU-C	8ft power cord 120-277V 8ft aircraft cable ⁷ 2x 5-inch canopies
-PH	8ft power cord 120-347V 8ft aircraft cable ⁷
-PH-C	8ft power cord 120-347V 8ft aircraft cable ⁷ 2x 5-inch canopies

-PU18-W18	18ft power cord 120-277V 18ft aircraft cable
-PU18-C-W18	18ft power cord 120-277V 18ft aircraft cable 2x 5-inch canopies
-PH18-W18	18ft power cord 120-347V 18ft suspension wires
-PH18-C-W18	18ft power cord 120-347V 18ft aircraft cable 2x 5-inch canopies

NOTES

- Default CCT setting is 3500K but can be changed upon request before shipping.
- Only available with Polycarbonate diffusers.
- Maple finish is only available for 4ft and 8ft fixtures.
- LDE1 is a Lutron Hi-lume EcoSystem driver with Soft-on; it requires color selection. If not, the default CCT is 3500K.
- EMBB option available in 120-277V only.
- 1DIM available only in 120-277V, only for 4, 5, 6, 8ft.

CAUTION

- If there are multiple fixtures connected to the same 0-10V dimming line, a 0-10V controller must be considered to enable consistent dimming across the fixtures. Failure to do so will lead to inconsistent dimming and behaviors in the fixtures. Single switch is not recommended for controlling multiple fixtures simultaneously.
- Maximum of 300W per electrical drop.

LINEAR LED LIGHT

Suspended Architectural Linear | 2.5" Aperture | Direct



ORDERING GUIDE – CUSTOM DESIGN

AE-SF-G5-					010	
AE-SF-G5- ERALUX G5 Suspended Architectural Linear	- Specify dimension of S1 (Select or type the length)	- Specify dimension of S2 (Select or type the length)	-R Rectangular Shape -L L-shape -T T-shape -X X-shape -HEX Hexagonal Shape	30/35/40¹ 3000/3500/4000K selectable 30/40/50 3000/4000/5000K selectable	010 0-10V Dimming	WH-GB White BK-GB Black

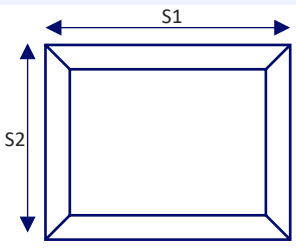
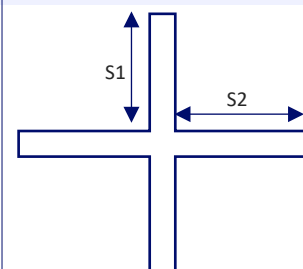
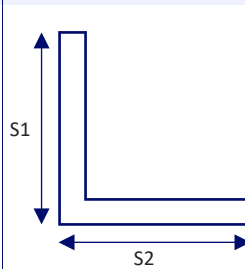
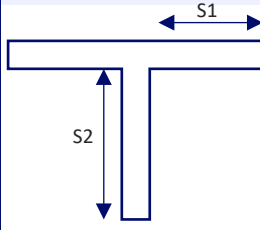
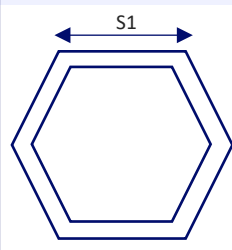
Fixture Family	Side 1	Side 2	Design	CCT	Controls	Finish
Rectangle 			X - Shape 	L - Shape 	T - Shape 	Hexagon 
For square, S1 equal to S2. S1 & S2 ≥ 2FT			Symmetrical sides	For equal sides, S1 equal to S2.	Symmetrical side	For Hexagon, All sides are equal to S1 ≥ 2FT

NOTES

- Only available with polycarbonate diffusers.
- For more complex designs, contact factory.
- The precise dimensions will be provided by factory upon request or refer to the dimensions on [Page 4](#).



ORDERING GUIDE – TRIAC Dimming

AE-SF-G5CA			-TRI	
ERALUX G5 Suspended Architectural Linear	2 15 2ft 20W 3150lm 4 40 4ft 40W 5250lm 8 80 8ft 80W 10500lm	30 3000K 35 3500K 40 4000k	-TRI TRIAC Dimming	-WH-GB White -BK-GB Black

Fixture Family	Length Power	CCT	Controls	Finish
----------------	----------------	-----	----------	--------

CAUTION

- If there are multiple fixtures connected to the same 0-10V dimming line, a 0-10V controller must be considered to enable consistent dimming across the fixtures. Failure to do so will lead to inconsistent dimming and behaviors in the fixtures. Single switch is not recommended for controlling multiple fixtures simultaneously.
- Maximum of 300W per electrical drop.

LINEAR LED LIGHT

Suspended Architectural Linear | 2.5" Aperture | Direct

DIMENSIONS – CUSTOM SHAPES

SHAPES

L-SHAPE
AE-SF-G5-1-1-L

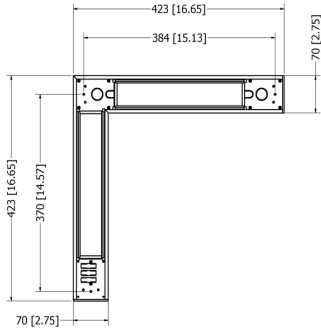

T-SHAPE
AE-SF-G5-1-1-T

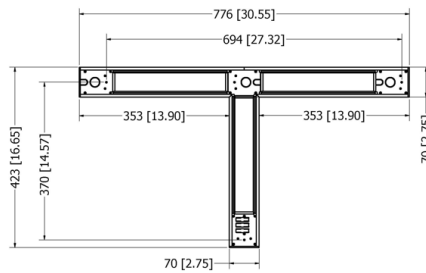

X-SHAPE
AE-SF-G5-1-1-X

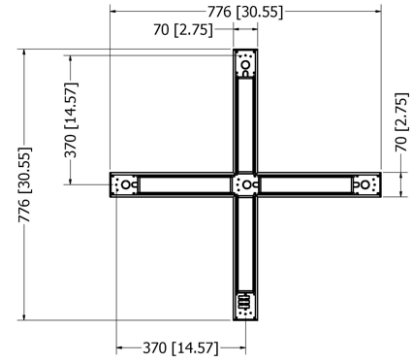

LUMEN OUTPUT

Efficacy: 110 LPW, 1100 lm/ft

LENGTH	OUTPUT POWER
2FT	15W 1650 lm
	20W 2200 lm
3FT	30W 3300 lm
4FT	30W 3300 lm
	40W 4400 lm

LENGTH	OUTPUT POWER
5FT	35W 3850 lm
	50W 5500 lm
6FT	35W 3850 lm
	50W 5500 lm
	60W 6600 lm
8FT	60W 6600 lm
	80W 8800 lm

DLC MODEL



DLC MODEL	PRODUCT ID	Primary Use	Classification
AE-SF-G5CA22030-35-40010YY-GB	S-JTCRUD	Direct Linear Ambient Luminaires	Standard
AE-SF-G5CA44030-35-40010YY-GB	S-ACNDT2		Standard
AE-SF-G5CA87030-35-40010YY-GB	S-09HDJM		Standard

DIMMER COMPATIBILITY LIST

0-10V Dimming

BRAND	MODEL	BRAND	MODEL
LEVITON	IP710-LFZ	LEGRAND	RH4FBL3PTC
	DS710	EATON	WBSD-010SLD
LUTRON	DVS7V-WH	HUBBLE	LHDIRS3N
	MS-Z101		

LINEAR LED LIGHT

Suspended Architectural Linear | 2.5" Aperture | Direct

DIMENSIONS

SIZE	TOP/BOTTOM VIEW	SIDE VIEW
2FT		
3FT		
4FT		
5FT		
6FT		
8FT		

LINEAR LED LIGHT

Suspended Architectural Linear | 2.5" Aperture | Direct

DRILLING PATTERN – STAND ALONE INSTALLATION

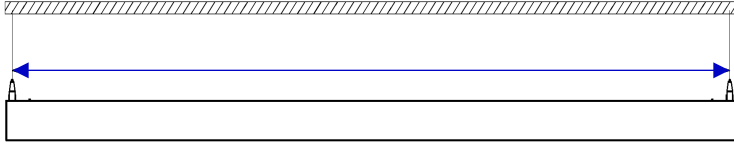

SIZE	STAND ALONE INSTALLATION
2FT	22.2 ± .10
3FT	34.02 ± .10
4FT	45.75 ± .10
5FT	57.64 ± .10
6FT	69.45 ± .10
8FT	93.07 ± .10

DRILLING PATTERN - CONTINUOUS RUN INSTALLATION

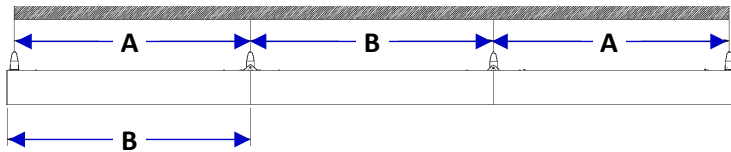

SIZE	CONTINUOUS RUN INSTALLATION	
	A	B
2FT	22.90 ± .10	23.62 ± .10
3FT	34.64 ± .10	35.36 ± .10
4FT	46.45 ± .10	47.17 ± .10
5FT	58.26 ± .10	58.98 ± .10
6FT	70.15 ± .10	70.87 ± .10
8FT	93.77 ± .10	94.49 ± .10

LINEAR LED LIGHT

Suspended Architectural Linear | 2.5" Aperture | Direct

ACCESSORIES – CONNECTIONS

LIT JOINERS

X-JOINER

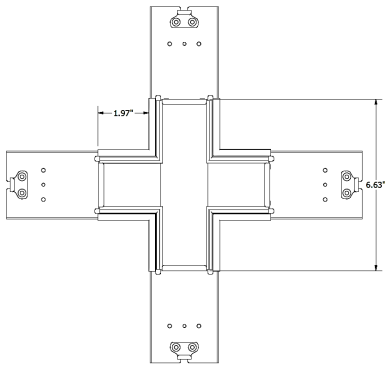

Y-JOINER

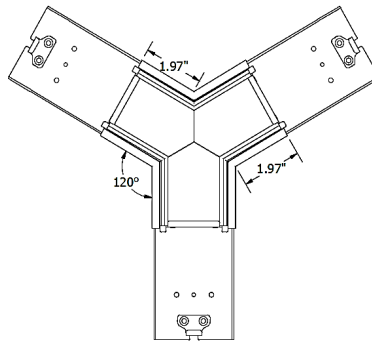

L-JOINER

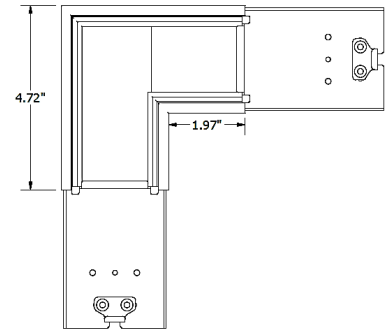

V-JOINER

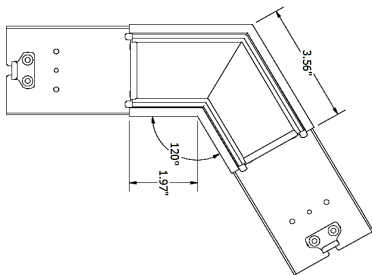

T-JOINER

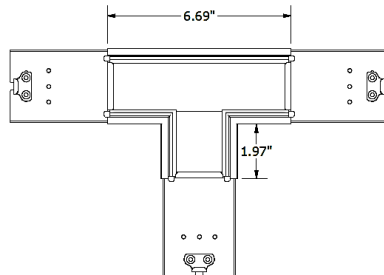

STRAIGHT CONNECTION

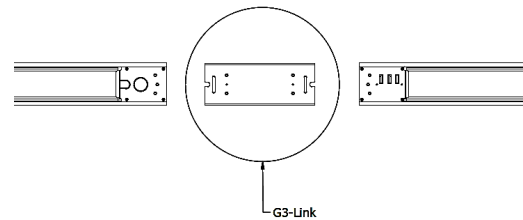

G3-LINK

ORDER CODE

AE-SF-LINK-G3

LIT JOINERS

ORDER CODE

Family	Shape	CCT	Finish
AE-SF-SPT/G5	-V	-30/35/40	-LJ-KIT-WH
	-X		-LJ-KIT-BK
	-T	-30/35/40	-LJ-KIT-MA
	-L		
	-Y		

HONEYCOMB PATTERN

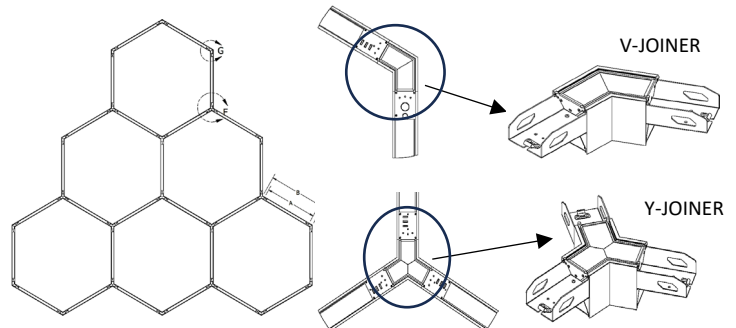

LINEAR LED LIGHT

Suspended Architectural Linear | 2.5" Aperture | Direct

ACCESSORIES – SUSPENSION

Ordered separately if needed

POWER CORD

ORDER CODE	DESCRIPTION	PICTURE
AE-SF-PWRCORD-WH AE-SF-PWRCORD-BK	8' white / black power cord with 120-277V input voltage	
AE-SF-PWRCORD-WH-18FT AE-SF-PWRCORD-BK-18FT	18' white / black power cord with 120-277V input voltage	
AE-SF-PWRCORD-HV-WH AE-SF-PWRCORD-HV-BK	8' white / black power cord with 120-347V input voltage	
AE-SF-PWRCORD-HV-WH-18FT AE-SF-PWRCORD-HV-BK-18FT	18' white / black power cord with 120-347V input voltage	

CANOPY

ORDER CODE	DESCRIPTION	PICTURE
AE-SF-CANOPY-WH-5IN AE-SF-CANOPY-BK-5IN	2 pieces per set white / black 5" canopy 0.8" thickness Dual hole for power cord & aircraft cable Single hole for aircraft cable	
AE-SF-CANOPY-WH-5IN-SUSP AE-SF-CANOPY-BK-5IN-SUSP	1 piece white / black 5" canopy 0.8" thickness For aircraft cable	
AE-SF-CANOPY-WH-ELITE AE-SF-CANOPY-BK-ELITE AE-SF-CANOPY-MA-ELITE	2 pieces per set white / black / maple 5" canopy 0.3" thickness Dual hole for power cord & aircraft cable Single hole for aircraft cable	

AIRCRAFT CABLE

ORDER CODE	DESCRIPTION	PICTURE
AE-SF-G5/SPT-WIRE-8FT	8ft aircraft cable 2 pieces per set 1 set / fixture	
AE-SF-G5/SPT-WIRE-18FT	18ft aircraft cable 2 pieces per set 1 set / fixture	

T-BAR PENDANT

ORDER CODE	DESCRIPTION
AE-SF-TCLIP-TBC	T-bar Pendant Clip
AE-SF-TCLIP-TBS	T-bar Pendant Clamp

LINEAR LED LIGHT

Suspended Architectural Linear | 2.5" Aperture | Direct

ACCESSORIES – ACOUSTIC HOUSING

Ordered separately if needed

Introducing the SILENCIO Series Acoustic Housing for the architectural linears by ERALUX. Designed to enhance sound quality and reduce noise in bustling environments, the SILENCIO features advanced sound-absorbing materials, ensuring optimal acoustic performance for spaces such as offices, conference rooms, and open-plan areas. These panels are fixed to the linear housing, offering a sleek and modern aesthetic while effectively dampening ambient noise. Easy to install using adhesives, the SILENCIO Series provides a versatile and efficient solution for creating quieter, more comfortable spaces.

TECHNICAL SPECIFICATIONS

MATERIAL	100% Polyester Fiber
NOISE REDUCTION COEFFICIENT (NRC)	0.80

SURFACE BURNING CHARACTERISTICS

FLAME SPREAD INDEX (FSI)	15
SMOKE DEVELOPED INDEX (SDI)	40
ASTM E84 (FIRE RATING) CLASSIFICATION	Class A (Highest flame inhibition class)
FLAME SPREAD INDEX (FSI)	15



ORDERING CODE

Family	Shape	CCT	Finish
AE-SIL	-2FT	-TIL	
	-4FT		
	-5FT	-BBQ	-G5CASE
	-6FT		
	-8FT	-SOY	



TILAPIA - #8E8C8C

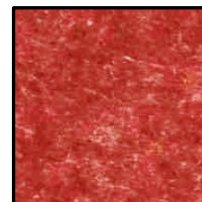

BBQ SAUCE - #CB4147

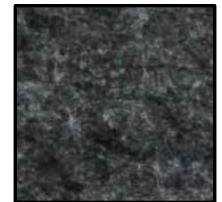

SOYA SAUCE - #454545

NOTES • See Silencio Housing spec sheet for more information (ONLY COLORS SHOWN ABOVE are offered for G5/SPT acoustic housing)

LINEAR LED LIGHT

Suspended Architectural Linear | 2.5" Aperture | Direct

LENS OPTIONS

DROP LENS

ORDER CODE

DESCRIPTION

PICTURE

AE-SF-G5/SPT-DROP LENS-0.5 INCH-XFT-WH
AE-SF-G5/SPT-Drop Lens-0.5 inch-XFT-BK

(X = 2, 4, 6 or 8)

Highly durable frosted polycarbonate lens provides glowing sides with crisp corners visible at a distance. This drop lens gives a 3D look to the light that will enliven your space and add wider spread to the surroundings.

Available sizes: 2FT, 4FT, 6FT, and 8FT.
23% less lumens. 0.5" thickness.

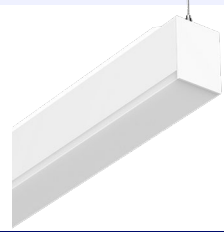

WALL WASH LENS

ORDER CODE

DESCRIPTION

PICTURE

AE-SF-G5/SPT-XFT-WW-KIT-WH
AE-SF-G5/SPT-XFT-WW-KIT-BK

(X = 2, 4, 5, 6 or 8)

Wall washing is a feature where the luminaire is typically positioned at least 12" from the wall to enhance the smoothness of a wall by eliminating shadows or to highlight a wall to create visual interest.

Available sizes: 2FT, 4FT, 5FT, 6FT, and 8FT.

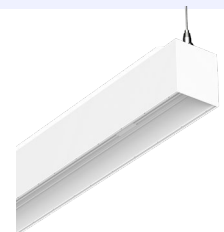

PRIME LENS

ORDER CODE

DESCRIPTION

PICTURE

Order using ordering guide. [Page 2](#)

The prime lens features a parabolic silver louver that offers outstanding light shielding and an attractive, crisp visual texture. Its parabolic blade design, along with side reflectors, effectively directs light, enhancing brightness and efficiency in lighting applications. The prime delivers a modern, sleek look, making it suitable for contemporary spaces.

Available sizes: 2FT, 4FT, 5FT, 6FT, and 8FT.
Efficacy: ~90Lm/W | UGR: 13.9 - 15.7



PRIME SHADOW LENS

ORDER CODE

DESCRIPTION

PICTURE

Order using ordering guide. [Page 2](#)

The prime shadow lens features a parabolic black louver that offers outstanding light shielding and an attractive, crisp visual texture. Its black parabolic blade design, along with side reflectors, effectively reduces glare by absorbing more light. Black louvers can create a more dramatic or industrial aesthetic, fitting well in design contexts.

Available sizes: 2FT, 4FT, 5FT, 6FT, and 8FT.
Efficacy: ~55Lm/W | UGR: 18.3 - 20.4



LINEAR LED LIGHT

Suspended Architectural Linear | 2.5" Aperture | Direct

CONTROLS

EMERGENCY LED DRIVER

BLD-YT08D-XXX

BLD-YT15D-XXX



The BLD-YTXXD-XXX series LED Emergency Driver is UL listed for field and factory installations. It switches to emergency mode during power failures, providing up to 90 minutes of lighting. With an integrated battery, charger, and converter, it delivers 8 or 15W constant power at 30-60VDC. Its slim shape is ideal for use in linear LED lighting fixtures.

SPECIFICATIONS

Input Voltage	30-60VDC
Power Frequency	50/60HZ
Output Voltage	30-60VDC
Output Power	8W 15W
Ambient Temperature	0°C to 50°C
	30°F to 122°F
Installation	Integrated

NOTES For 8ft fixtures, EMBB will only power a 4ft portion

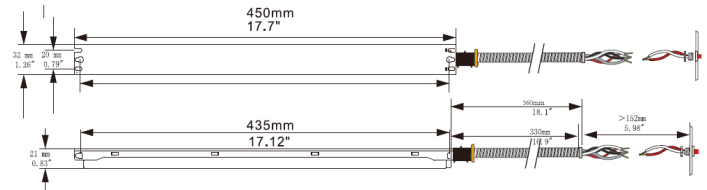
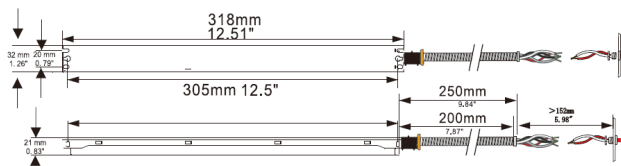

ROOM OCCUPANCY SENSOR

Ordered separately, field installed

PART NUMBER	DESCRIPTION
AE-CT-DT806	Detecta - Room Occupancy Sensor
RC102	Remote Control

SPECIFICATIONS

Input Voltage	120-277 Vac
Power Frequency	50/60HZ
Rated Load	At 120 Vac 800W
	At 277 Vac 1200W
Detection Range	3-10 m
	9.8- 32.8 ft
Standby Power	~0.9W
Time Setting	10 sec to 30 min
Light Control	10 – 2000lux
Installation	Ceiling Mounted

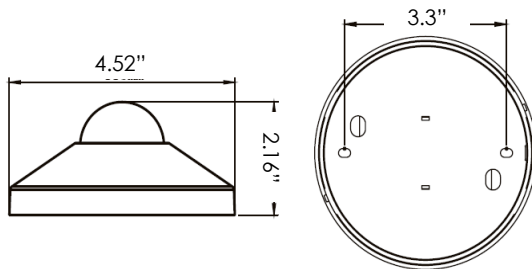

LINEAR LED LIGHT

Suspended Architectural Linear | 2.5" Aperture | Direct

LUMEN ESTIMATE

Lumen output varies based on CCT and CRI. Use correction factors as per table below:

LUMEN ESTIMATE ADJUSTMENT FACTORS

CCT	3000K	3500K	4000K	5000K
PREMIUM (90CRI)	0.94	0.97	1	1.03

PHOTOMETRIC DATA

PART NUMBER		ZONAL LUMEN SUMMARY			POLAR LUMINOUS INTENSITY	CONE DISTRIBUTION		
		Zone	Lumens	% Fixture	Direct Light	Center Beam Fc		Beam Width
AE-SF-G5CA220								
Wattage	20W	0-20°	294.61	12.90		1.7ft	280 fc	5.0 ft 4.8 ft
CCT	4000K	0-30°	623.47	27.20		3.3ft	74.3 fc	9.7 ft 9.3 ft
Distribution	120°	0-40°	1017.77	44.40		5.0ft	32.4 fc	14.8 ft 14.0 ft
Length	2ft	0-60°	1789.99	78.10		6.7ft	18 fc	19.8 ft 18.8 ft
		0-80°	2225.05	97.10		8.3ft	11.7 fc	24.5 ft 23.3 ft
		0-90°	2265.42	98.90	10.0ft	8.09 fc	29.5 ft 28.1 ft	
					■ Vert. Spread: 111.7° ■ Horiz. Spread: 109.1°			
AE-SF-G5CA440								
Wattage	40W	0-20°	525.87	12.9		1.7ft	500 fc	5.0 ft 4.8 ft
CCT	4000K	0-30°	1112.9	27.2		3.3ft	133 fc	9.7 ft 9.3 ft
Distribution	120°	0-40°	1816.72	44.4		5.0ft	57.8 fc	14.8 ft 14.0 ft
Length	4ft	0-60°	3194.96	78.1		6.7ft	32.2 fc	19.8 ft 18.8 ft
		0-80°	3971.71	97.1		8.3ft	21 fc	24.5 ft 23.3 ft
		0-90°	4043.77	98.9	10.0ft	14.4 fc	29.5 ft 28.1 ft	
					■ Vert. Spread: 111.7° ■ Horiz. Spread: 109.1°			
AE-SF-G5CA660								
Wattage	60W	0-20°	751.25	12.9		1.7ft	714 fc	5.0 ft 4.8 ft
CCT	4000K	0-30°	1589.85	27.2		3.3ft	189 fc	9.7 ft 9.3 ft
Distribution	120°	0-40°	2595.32	44.4		5.0ft	82.5 fc	14.8 ft 14.0 ft
Length	6ft	0-60°	4564.23	78.1		6.7ft	46 fc	19.8 ft 18.8 ft
		0-80°	5673.88	97.1		8.3ft	29.9 fc	24.5 ft 23.3 ft
		0-90°	5776.82	98.9	10.0ft	20.6 fc	29.5 ft 28.1 ft	
					■ Vert. Spread: 111.7° ■ Horiz. Spread: 109.1°			
AE-SF-G5CA880								
Wattage	80W	0-20°	981.56	12.90		1.7ft	933 fc	5.0 ft 4.8 ft
CCT	4000K	0-30°	2077.26	27.20		3.3ft	248 fc	9.7 ft 9.3 ft
Distribution	120°	0-40°	3390.97	44.40		5.0ft	108 fc	14.8 ft 14.0 ft
Length	8ft	0-60°	5963.5	78.10		6.7ft	60 fc	19.8 ft 18.8 ft
		0-80°	7413.33	97.10		8.3ft	39.1 fc	24.5 ft 23.3 ft
		0-90°	7547.83	98.90	10.0ft	27 fc	29.5 ft 28.1 ft	
					■ Vert. Spread: 111.7° ■ Horiz. Spread: 109.1°			

LINEAR LED LIGHT

Suspended Architectural Linear | 2.5" Aperture | Direct

PHOTOMETRIC DATA – LENS OPTIONS

PART NUMBER		ZONAL LUMEN SUMMARY			POLAR LUMINOUS INTENSITY	CONE DISTRIBUTION				
AE-SF-G5CA44030/35/40X-DL		Zone	Lumens	% Fixture		Center Beam Fc				
Wattage		40W	0-20°	420.45		11.9	Beam Width			
CCT		4000K	0-30°	882.52		24.9	2.5ft	186 fc	6.5 ft	7.2 ft
Distribution		120°	0-40°	1428.38		40.4	5.0ft	46.6 fc	12.9 ft	14.5 ft
Length		4ft	0-60°	2493.86		70.5	7.5ft	20.7 fc	19.4 ft	21.7 ft
DROP LENS		0-80°	3150.06	89		10.0ft	11.6 fc	25.8 ft	28.9 ft	
		0-90°	3267.17	92.3		12.5ft	7.45 fc	32.3 ft	36.2 ft	
						15.0ft	5.17 fc	38.7 ft	43.4 ft	
						■ Vert. Spread: 104.5° ■ Horiz. Spread: 110.7°				
PART NUMBER		ZONAL LUMEN SUMMARY			POLAR LUMINOUS INTENSITY	CONE DISTRIBUTION				
AE-SF-G5CA45030/35/40X-WW		Zone	Lumens	% Fixture		Center Beam Fc				
Wattage		50W	0-20°	931.99		13.4	Beam Width			
CCT		4000K	0-30°	2174.46		31.3	2.5ft	347 fc	3.5 ft	1.4 ft
Distribution		120°	0-40°	3457.33		49.8	5.0ft	86.8 fc	6.9 ft	2.8 ft
Length		4ft	0-60°	4537.37		65.3	7.5ft	38.6 fc	10.4 ft	4.1 ft
WALL WASH LENS		0-80°	4827.69	69.5		10.0ft	21.7 fc	13.9 ft	5.5 ft	
		0-90°	4850.9	69.8		12.5ft	13.9 fc	17.3 ft	6.9 ft	
						15.0ft	9.65 fc	20.8 ft	8.3 ft	
						■ Vert. Spread: 69.5° ■ Horiz. Spread: 30.9°				
PART NUMBER		ZONAL LUMEN SUMMARY			POLAR LUMINOUS INTENSITY	CONE DISTRIBUTION				
AE-SF-G5CA44030/35/40X-P		Zone	Lumens	% Fixture		Center Beam Fc				
Wattage		40W	0-20°	967.59		27.6	Beam Width			
CCT		4000K	0-30°	1905.45		54.4	2.5ft	178 fc	7.2 ft	6.9 ft
Distribution		120°	0-40°	2736.19		78.2	5.0ft	44.5 fc	14.4 ft	13.8 ft
Length		4ft	0-60°	3454.72		98.7	7.5ft	19.8 fc	21.7 ft	20.7 ft
PRIME		0-80°	3483.38	99.5		10.0ft	11.1 fc	28.9 ft	27.6 ft	
		0-90°	3485.56	99.6		12.5ft	7.11 fc	36.1 ft	34.5 ft	
						15.0ft	4.94 fc	43.3 ft	41.5 ft	
						■ Vert. Spread: 110.6° ■ Horiz. Spread: 108.2°				
PART NUMBER		ZONAL LUMEN SUMMARY			POLAR LUMINOUS INTENSITY	CONE DISTRIBUTION				
AE-SF-G5CA44030/35/40X-PS		Zone	Lumens	% Fixture		Center Beam Fc				
Wattage		40W	0-20	523.96		23.4	Beam Width			
CCT		4000K	0-30	1069.19		47.8	2.5ft	233 fc	3.1 ft	5.1 ft
Distribution		120°	0-40	1601.34		71.6	5.0ft	58.4 fc	6.3 ft	10.3 ft
Length		4ft	0-60	2178.89		97.4	7.5ft	25.9 fc	9.4 ft	15.4 ft
PRIME SHADOW		0-80	2230.17	99.7		10.0ft	14.6 fc	12.5 ft	20.5 ft	
		0-90	2231.01	99.8		12.5ft	9.34 fc	15.6 ft	25.6 ft	
						15.0ft	6.49 fc	18.8 ft	30.8 ft	
						■ Vert. Spread: 64.0° ■ Horiz. Spread: 91.5°				

LINEAR LED LIGHT

Suspended Architectural Linear | 2.5" Aperture | Direct

OVERVIEW

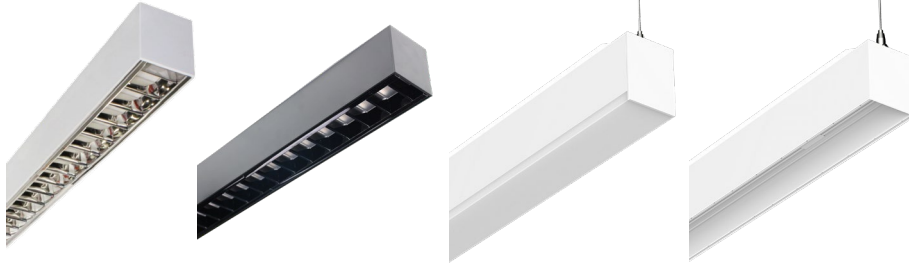

Innovative Design

- Extruded aluminum housing for better heat dissipation.
- Highly durable polycarbonate and high transmittance lens.



Diffusers

- Polycarbonate lens
- Wall-wash lens
- 0.5-inch drop lens
- Black/silver parabolic louver



Multiple Options

- Six standard lengths available: 2, 3, 4, 5, 6 & 8ft.
- CCT switchable and power tunable.
- Black, white, silver, gun powder and maple finishes.



Features

- 1% dimming option
- Lutron Hi-lume Ecosystem driver with Soft-on



Emergency Backup Battery



Mountings Available

- Suspended
- Wall mount (refer to the wall mount spec sheet)
- Recessed T-grid (refer to the recessed T-grid spec sheet)



Custom Design

- Continuous lens; increment of 2'
- L, T, X & rectangular shapes
- Honeycomb design using lit joiners

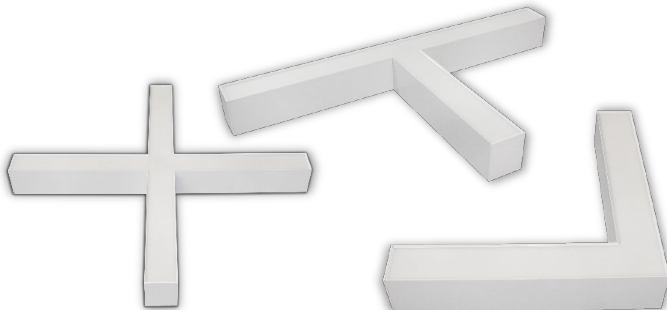

Tests And Certifications

