

LED COMMERCIAL DOWNLIGHT

Recessed Downlight | 4", 6", & 8" Round

The GALAXY is a recessed downlight offers a range of optical options. Variety of reflectors and trim finishes available making it an attractive addition. It comes in round shape. It is available in multiple power switchable options 18/24/30W for 4" & 6" or 30/40/50W for 6" and 8" multiple CCTs and adjustable beam angles, with low UGR 16, 19
Applications: Schools | Show Rooms | Retail Stores | Hospitality | Offices | Commercial

DATE	QTY	ACC. QTY	TYPE
PROJECT			
PN			
ACCESSORY PN			
NOTES			



DYNAMIC MENU

Order Information	Page 2
Dimensions	Page 3
Accessories	Page 5
Photometric Data	Page 8

[Install Instruction link](#)

SPECIFICATIONS

Input Voltage	120-347V
Power Factor	>0.9
Total Harmonic Distortion	<20%
Dimming Page 7	TRIAC & 0-10V (down 10%) for 30W 0-10V (down to 1%) for 50W
CRI	90 CRI
CCT	<div style="display: flex; gap: 10px;"> <div style="background-color: #fff9c4; border-radius: 50%; width: 20px; height: 20px; display: flex; align-items: center; justify-content: center;">27K</div> <div style="background-color: #fff176; border-radius: 50%; width: 20px; height: 20px; display: flex; align-items: center; justify-content: center;">30K</div> <div style="background-color: #fff9c4; border-radius: 50%; width: 20px; height: 20px; display: flex; align-items: center; justify-content: center;">35K</div> <div style="background-color: #bbdefb; border-radius: 50%; width: 20px; height: 20px; display: flex; align-items: center; justify-content: center;">40K</div> <div style="background-color: #bbdefb; border-radius: 50%; width: 20px; height: 20px; display: flex; align-items: center; justify-content: center;">50K</div> </div>
Efficacy	~70-100 lm/W
Size and Power	4 inch 18/24/30W 6 inch 18/24/30W 30/40/50W 8 inch 30/40/50W
Ambient Temperature Range	-25°C to 40°C
Mounting Options	New construction Retrofit
Reflector/Flange Finish	<div style="display: flex; gap: 10px;"> <div style="background-color: black; width: 20px; height: 20px; border-radius: 50%;"></div> <div style="background-color: gray; width: 20px; height: 20px; border-radius: 50%;"></div> <div style="background-color: white; width: 20px; height: 20px; border-radius: 50%;"></div> </div>
Protection	Wet Rated; suitable for wet location 2.5KV Surge Protector
Adjustable beam angle	24°-36°-60° for 30W 36°-42°-65° for 50W
Distribution	<div style="display: flex; justify-content: space-around; align-items: center;"> <div style="text-align: center;"> 24° </div> <div style="text-align: center;"> 36° </div> <div style="text-align: center;"> 42° </div> <div style="text-align: center;"> 60° </div> </div>



PRODUCT FEATURE

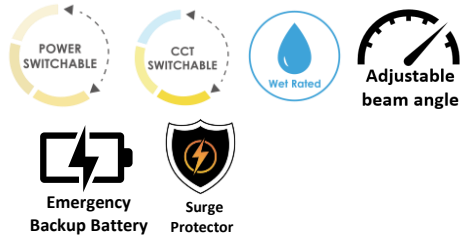

PRODUCT CERTIFICATIONS



SYSTEM WARRANTY – 5 YEARS

Eralux will warrant defective drivers, LEDs and boards for 5 years from the date of purchase. This warranty is valid only if the fixture is installed and used as per installation guides and specifications. If a defect is present, Eralux will send drivers and boards at no fee with a thorough replacement instructions along with instructions on the return of the defective parts back to Eralux.

LUMEN MAINTENANCE – L70 at 50,000 hours

Rated for 70% initial lumen output at 50,000 hours of operation, operated at 25°C ambient temperature; per guidelines published by the Illuminating Engineering Society (IES).

LED COMMERCIAL DOWNLIGHT

Recessed Downlight | 4", 6", & 8" Round



ORDERING GUIDE



AE-DL-GX

ERALUX GALAXY Round
Recessed downlight

120-347V

-4R | -30W

4 inch | 30/24/18W

-6R | -30W

6 inch | 30/24/18W

-6R | -50W

6 inch | 50/40/30W

-8R | -30W

8 inch | 30/24/18W

-8R | -50W

8 inch | 50/40/30W

-275

27/30/35/40/50K
Switchable

90CRI

-WH | W

Matte White Reflector and Flange

-BK | B

Matte Black Reflector and Flange

-SV | S

Matte Silver Reflector and Flange

Fixture Family

Size | Power

CCT

Reflector | Flange Finish

Module	Input Voltage	Power	LPW	Lumens	Beam Angle	Dimming	IC Rating	Flange Size
30W	120-347V	30/24/18W	~70-100	2700/2400/1800lm	Adjustable 24°-36°-60°	0-10V (Down to 10%)	Non-IC rated	4 6 8 inch
50W		50/40/30W		4550/4000/3000lm	Adjustable 36°-42°-65°	0-10V (Down to 1%)	Non-IC rated	6 8 inch

BEAM ANGLE

UGR

24°

<16

24°-42°

<19



ORDERING GUIDE – FRAME KIT | EMBB



AE-DL-FRKT

ERALUX
FRAME KITS
Round Downlights

[BLANK]

Frame kit
Chicago plenum

-PL

-04

4 Inches

-06

6 Inches

-08

8 Inches

[BLANK]

No EMBB

BLD-HM8D-YYY

8W emergency battery
backup

EMBB

Fixture Family

Option

SIZE

NOTES

- Junction Box is included with the frame kit.

LED COMMERCIAL DOWNLIGHT

Recessed Downlight | 4", 6", & 8" Round

DIMENSIONS

DRIVER & LIGHT ENGINE

30W

50W

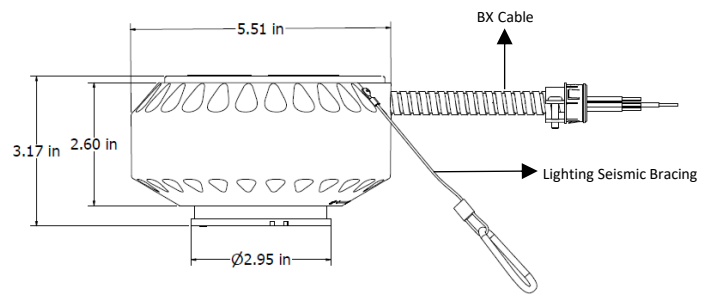
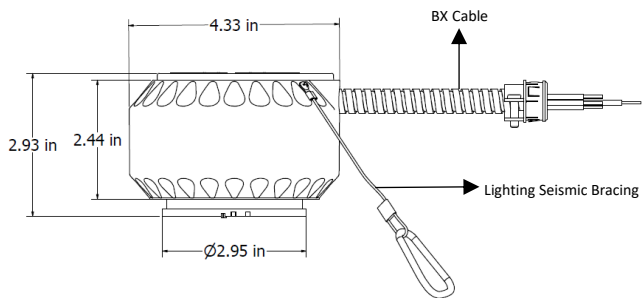

BX Cable length: 17 in – 18 in
Lighting Seismic Bracing Length: 19 in

REFLECTOR

4" ROUND

6" ROUND

8" ROUND

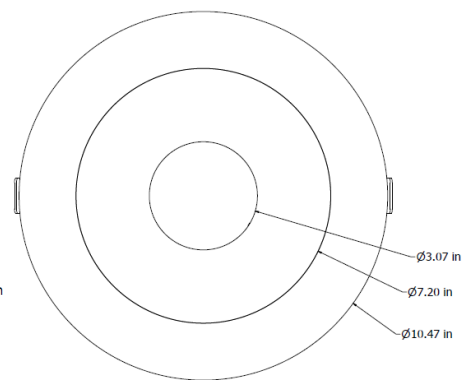
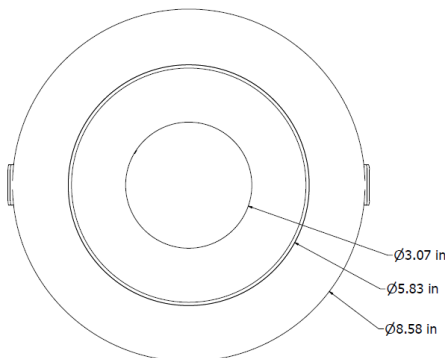
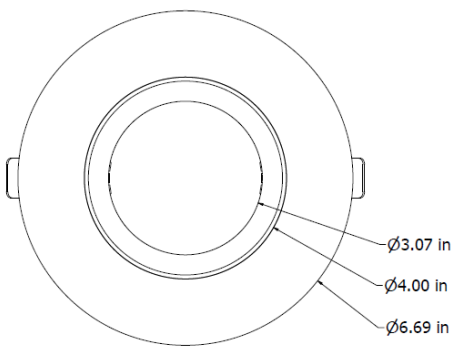
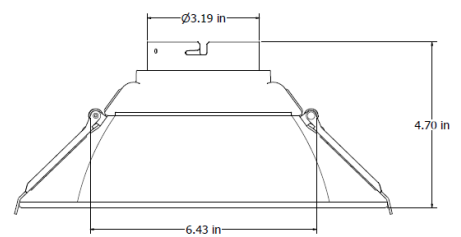
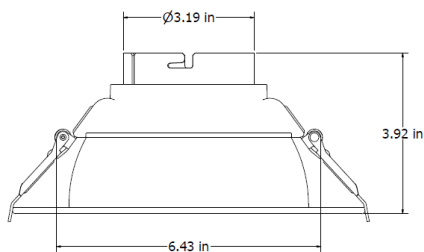
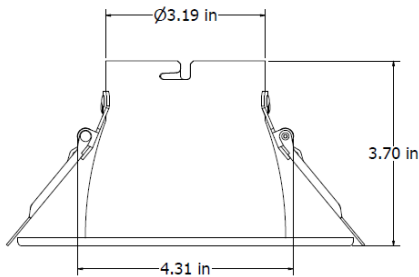

LED COMMERCIAL DOWNLIGHT

Recessed Downlight | 4", 6", & 8" Round

DIMENSIONS

FIXTURE

AE-DL-GX-4R-30W

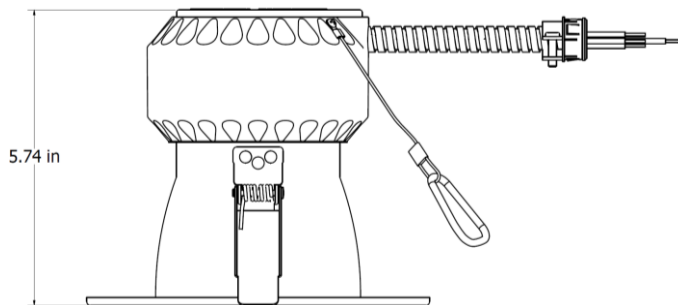

Ceiling cut-out:
4.75 in Ø

AE-DL-GX-6R-30W

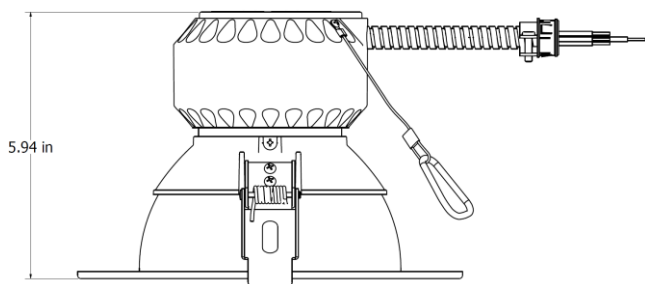

Ceiling cut-out:
7 in Ø

AE-DL-GX-6R-50W

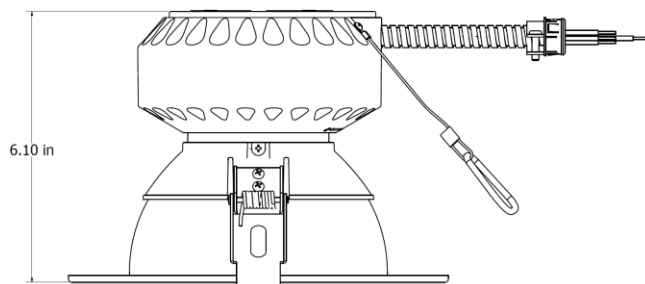

AE-DL-GX-8R-30W

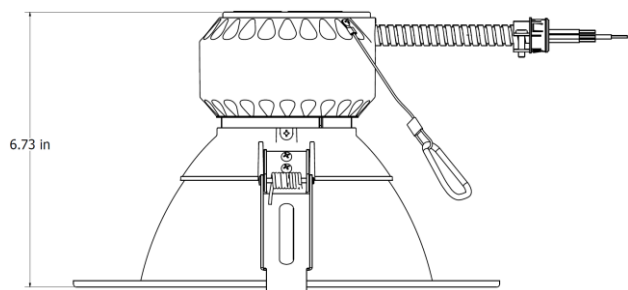

Ceiling cut-out:
8 in Ø

AE-DL-GX-8R-50W

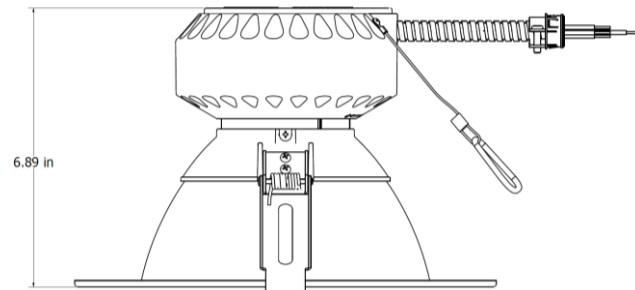

LED COMMERCIAL DOWNLIGHT

Recessed Downlight | 4", 6", & 8" Round

ADJUSTABLE BEAM ANGLE

DRIVER & LIGHT ENGINE

30W

Adjustable beam angle to any value between 24°, 36° and 60°
Place the arrow at the desired angle by twisting the lens before installing the reflector

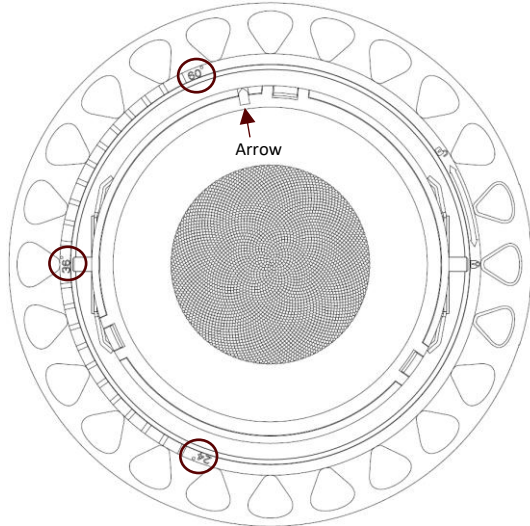

50W

Adjustable beam angle to any value between 36°, 42° and 65°
Place the arrow at the desired angle by twisting the lens before installing the reflector

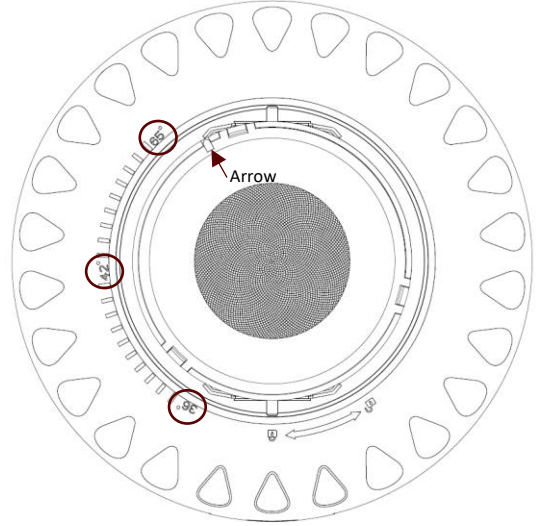

REFLECTOR

FINISH

SHAPE

WHITE

DIFFUSED SILVER

BLACK

4-inch



6-inch



8-inch



DESCRIPTION

Maximizes and diffuses light, providing soft and even illumination.

Evenly scatters light, creating a soft, balanced illumination with reduced glare.

Absorbs light, creating a focused and dramatic effect with minimized glare.

LED COMMERCIAL DOWNLIGHT

Recessed Downlight | 4", 6", & 8" Round

MOUNTING ACCESSORIES

Ordered separately, field installed.

NEW CONSTRUCTION FRAME KIT

SPECIFICATIONS	
MATERIAL	<ul style="list-style-type: none"> 22-gauge galvanized steel housing Galvanized steel junction box with multiple knockouts
MOUNTING	T Grid Ceiling
	Gypsum Ceiling
	Maximum Thickness ~1.5"
LENGTH (A)	12.75"
WIDTH (B)	8.63"

OPENING SIZE			
ORDERING CODE	SIZE	SHAPE	C
AE-DL-FRKT-04	4"	Round	Ø 4.5"
AE-DL-FRKT-06	6"	Round	Ø 6.37"
AE-DL-FRKT-08	8"	Round	Ø 7.25"

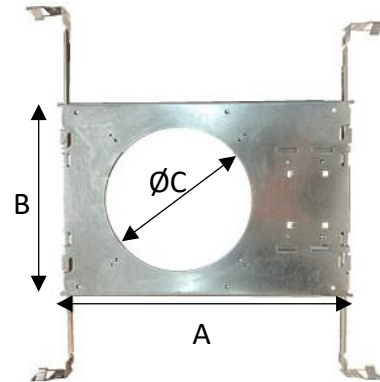

CHICAGO PLENUM

SPECIFICATIONS	
MATERIAL	27-gauge galvanized steel frame Galvanized steel junction box with gasket
MOUNTING	T-bar or drywall ceilings Up to 1.5" thick

OPENING SIZE		
ORDERING CODE	SIZE	SHAPE
AE-DL-FRKT-PL-04	4"	Round
AE-DL-FRKT-PL-06	6"	Round
AE-DL-FRKT-PL-08	8"	Round

COMPONENTS

- Chicago Plenum External Cover
- Chicago Plenum Internal Cover
- Chicago Plenum I.C. Box
- Chicago Plenum 4-inch Plaster Frame
- Chicago Plenum 6-inch Plaster Frame
- Chicago Plenum 8-inch Plaster Frame
- Chicago Plenum Suspension Bars (2 sets)

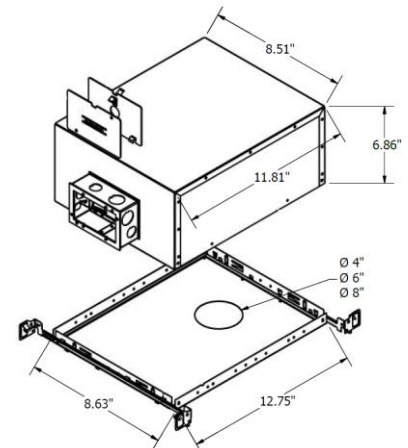

LED COMMERCIAL DOWNLIGHT

Recessed Downlight | 4", 6", & 8" Round

CONTROLS

Ordered separately, field installed

EMERGENCY LED DRIVER (BLD-HMXXD-YYY)

BLD-HM8D-YYY



The BLD-HMXXD-YYY series LED Emergency Driver is UL listed for field and factory installations. It switches to emergency mode during power failures, providing up to 90 minutes of lighting. With an integrated battery, charger, and converter, it delivers 6-25W constant power at 170VDC. Ideal for 0-10V dimmable indoor commercial LED fixtures, such as flat panels, troffers, downlights, and linear strip lights.

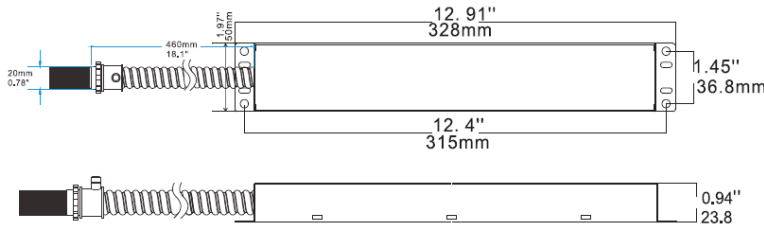

ROOM OCCUPANCY SENSOR

PART NUMBER	DESCRIPTION
AE-CT-DT806	Line Voltage Motion Sensor
RC102	RC102 Remote Control

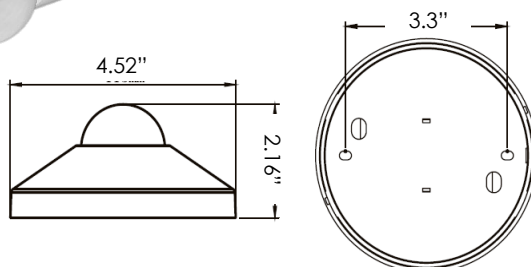

SPECIFICATIONS	
Input Voltage	100-347 Vac
Power Frequency	50/60HZ
Input Power	8W max
Output Voltage	170V Dc
Output Power	8W
Ambient Temperature	0°C to 50°C
	30°F to 122°F
Installation	Remote

SPECIFICATIONS		
Input Voltage	120-277 Vac	
Power Frequency	50/60HZ	
Rated Load	At 120 Vac	800W
	At 277 Vac	1200W
Detection Range	3-10 Meters	
	9.8-32.8 Feet	
Standby Power	~0.9W	
Time Setting	10 sec to 30 min	
Light Control	10-2,000LUX	
Installation	Ceiling Mounted	

LED COMMERCIAL DOWNLIGHT

Recessed Downlight | 4", 6", & 8" Round

DIMMER COMPATIBILITY LIST

0-10V DIMMING

Brand	Model
LUTRON	RMJS-8TN-DV-B
	DVSTV-36WH29
	DVSTV-WH
LEGRAND	RH4FBL3PTCCCV6
	RH4FBL3PTC
LEVITON	IP710-LFZ

LUMEN ESTIMATE

Lumen output varies based on CCT and CRI. An estimate of lumen output of the various CCT/CRI combinations, use correction factors as per table below:

LUMEN ESTIMATE ADJUSTMENT FACTORS				
CCT	2700K	3000K	3500K	4000K
PREMIUM (90CRI)	0.94	1	1.02	1.03

PHOTOMETRIC DATA

PART NUMBER		ZONAL LUMEN SUMMARY			POLAR LUMINOUS INTENSITY	CONE DISTRIBUTION			
AE-DL-GX-4R-30W		Zone	Lumens	% Fixture	Direct Light	Center Beam Fc	Beam Width		
Wattage	30W	0-20°	1206.72	52.3		2.5ft	1234 fc	1.3 ft	0.8 ft
CCT	4000K	0-30°	1735.72	75.2		5.0ft	309 fc	2.5 ft	1.7 ft
Distribution	24°	0-40°	2048.22	88.8		7.5ft	137 fc	3.8 ft	2.5 ft
SIZE	4"	0-60°	2213.54	95.9		10.0ft	77.1 fc	5.0 ft	3.4 ft
UGR	15.8	0-80°	2288.18	99.2		12.5ft	49.4 fc	6.3 ft	4.2 ft
		0-90°	2307.79	100		15.0ft	34.3 fc	7.6 ft	5.1 ft
						■ Vert. Spread: 28.3° ■ Horiz. Spread: 19.3°			

PART NUMBER		ZONAL LUMEN SUMMARY			POLAR LUMINOUS INTENSITY	CONE DISTRIBUTION			
AE-DL-GX-4R-30W		Zone	Lumens	% Fixture	Direct Light	Center Beam Fc	Beam Width		
Wattage	30W	0-20°	678.09	36.4		2.5ft	320 fc	2.8 ft	2.7 ft
CCT	4000K	0-30°	1219.32	65.4		5.0ft	80.1 fc	5.6 ft	5.3 ft
Distribution	60°	0-40°	1515.69	81.3		7.5ft	35.6 fc	8.4 ft	8.0 ft
SIZE	4"	0-60°	1732	92.9		10.0ft	20 fc	11.2 ft	10.6 ft
UGR	20	0-80°	1847.87	99.1		12.5ft	12.8 fc	14.0 ft	13.3 ft
		0-90°	1864.44	100		15.0ft	8.9 fc	16.8 ft	15.9 ft
						■ Vert. Spread: 58.5° ■ Horiz. Spread: 56.0°			

LED COMMERCIAL DOWNLIGHT

Recessed Downlight | 4", 6", & 8" Round

PHOTOMETRIC DATA

PART NUMBER		ZONAL LUMEN SUMMARY			POLAR LUMINOUS INTENSITY	CONE DISTRIBUTION			
AE-DL-GX-6R-30W		Zone	Lumens	% Fixture	Direct Light	Center Beam Fc	Beam Width		
Wattage	30W	0-20°	1521.17	52.9		2.5ft	1366 fc	1.2 ft	1.1 ft
CCT	5000K	0-30°	2144.91	74.6		5.0ft	342 fc	2.4 ft	2.2 ft
Distribution	24°	0-40°	2561.36	89.1		7.5ft	152 fc	3.6 ft	3.2 ft
SIZE	6"	0-60°	2804.64	97.5		10.0ft	85.4 fc	4.8 ft	4.3 ft
UGR	12.8	0-80°	2860.26	99.5		12.5ft	54.6 fc	6.0 ft	5.4 ft
		0-90°	2875.41	100		15.0ft	37.9 fc	7.2 ft	6.5 ft
						■ Vert. Spread: 27.2° ■ Horiz. Spread: 24.4°			

PART NUMBER		ZONAL LUMEN SUMMARY			POLAR LUMINOUS INTENSITY	CONE DISTRIBUTION			
AE-DL-GX-6R-30W		Zone	Lumens	% Fixture	Direct Light	Center Beam Fc	Beam Width		
Wattage	30W	0-20°	706.4	30.7		2.5ft	323 fc	3.3 ft	3.3 ft
CCT	5000K	0-30°	1369.28	59.5		5.0ft	80.8 fc	6.7 ft	6.6 ft
Distribution	60°	0-40°	1895.57	82.3		7.5ft	35.9 fc	10.0 ft	9.9 ft
SIZE	6"	0-60°	2179.16	94.6		10.0ft	20.2 fc	13.4 ft	13.2 ft
UGR	17.5	0-80°	2281.93	99.1		12.5ft	12.9 fc	16.7 ft	16.6 ft
		0-90°	2303.14	100		15.0ft	8.97 fc	20.1 ft	19.9 ft
						■ Vert. Spread: 67.6° ■ Horiz. Spread: 67.0°			

PART NUMBER		ZONAL LUMEN SUMMARY			POLAR LUMINOUS INTENSITY	CONE DISTRIBUTION			
AE-DL-GX-6R-50W		Zone	Lumens	% Fixture	Direct Light	Center Beam Fc	Beam Width		
Wattage	50W	0-20°	1811.63	38.9		2.5ft	1246 fc	1.5 ft	1.4 ft
CCT	5000K	0-30°	2910.61	62.5		5.0ft	311 fc	3.0 ft	2.8 ft
Distribution	36°	0-40°	3801.12	81.6		7.5ft	138 fc	4.5 ft	4.2 ft
SIZE	6"	0-60°	4463.35	95.8		10.0ft	77.9 fc	6.1 ft	5.5 ft
UGR	19.5	0-80°	4631.05	99.4		12.5ft	49.8 fc	7.6 ft	6.9 ft
		0-90°	4658.62	100		15.0ft	34.6 fc	9.1 ft	8.3 ft
						■ Vert. Spread: 33.7° ■ Horiz. Spread: 30.9°			

PART NUMBER		ZONAL LUMEN SUMMARY			POLAR LUMINOUS INTENSITY	CONE DISTRIBUTION			
AE-DL-GX-6R-50W		Zone	Lumens	% Fixture	Direct Light	Center Beam Fc	Beam Width		
Wattage	50W	0-20°	1153.73	27.6		2.5ft	579 fc	3.1 ft	3.5 ft
CCT	5000K	0-30°	2226.48	53.3		5.0ft	145 fc	6.3 ft	7.0 ft
Distribution	65°	0-40°	3201.29	76.7		7.5ft	64.3 fc	9.4 ft	10.4 ft
SIZE	6"	0-60°	3921.45	93.9		10.0ft	36.2 fc	12.5 ft	13.9 ft
UGR	21.4	0-80°	4141.2	99.2		12.5ft	23.2 fc	15.7 ft	17.4 ft
		0-90°	4175.62	100		15.0ft	16.1 fc	18.8 ft	20.9 ft
						■ Vert. Spread: 64.2° ■ Horiz. Spread: 69.6°			

LED COMMERCIAL DOWNLIGHT

Recessed Downlight | 4", 6", & 8" Round

PHOTOMETRIC DATA

PART NUMBER		ZONAL LUMEN SUMMARY			POLAR LUMINOUS INTENSITY	CONE DISTRIBUTION			
AE-DL-GX-8R-30W		Zone	Lumens	% Fixture	Direct Light	Center Beam Fc	Beam Width		
Wattage	30W	0-20°	1457.61	55.6		2.5ft	1171 fc	1.3 ft	1.0 ft
CCT	2700K	0-30°	2017.32	77		5.0ft	293 fc	2.5 ft	1.9 ft
Distribution	24°	0-40°	2378.52	90.8		7.5ft	130 fc	3.8 ft	2.9 ft
SIZE	8"	0-60°	2562.68	97.8		10.0ft	73.2 fc	5.0 ft	3.9 ft
UGR	12.4	0-80°	2608.59	99.6		12.5ft	46.8 fc	6.3 ft	4.8 ft
		0-90°	2619.61	100		15.0ft	32.5 fc	7.6 ft	5.8 ft
						■ Vert. Spread: 28.3° ■ Horiz. Spread: 21.9°			

PART NUMBER		ZONAL LUMEN SUMMARY			POLAR LUMINOUS INTENSITY	CONE DISTRIBUTION			
AE-DL-GX-8R-30W		Zone	Lumens	% Fixture	Direct Light	Center Beam Fc	Beam Width		
Wattage	30W	0-20°	697.29	31.9		2.5ft	342 fc	3.0 ft	3.3 ft
CCT	2700K	0-30°	1329.96	60.8		5.0ft	85.4 fc	6.1 ft	6.5 ft
Distribution	60°	0-40°	1833.5	83.8		7.5ft	38 fc	9.1 ft	9.8 ft
SIZE	8"	0-60°	2096.86	95.9		10.0ft	21.4 fc	12.2 ft	13.1 ft
UGR	16.6	0-80°	2173.74	99.4		12.5ft	13.7 fc	15.2 ft	16.3 ft
		0-90°	2187.04	100		15.0ft	9.49 fc	18.3 ft	19.6 ft
						■ Vert. Spread: 62.7° ■ Horiz. Spread: 66.3°			

PART NUMBER		ZONAL LUMEN SUMMARY			POLAR LUMINOUS INTENSITY	CONE DISTRIBUTION			
AE-DL-GX-8R-50W		Zone	Lumens	% Fixture	Direct Light	Center Beam Fc	Beam Width		
Wattage	50W	0-20°	1939.17	40.5		2.5ft	1402 fc	1.5 ft	1.5 ft
CCT	4000K	0-30°	3088.35	64.5		5.0ft	351 fc	3.0 ft	2.9 ft
Distribution	36°	0-40°	3999.09	83.5		7.5ft	156 fc	4.5 ft	4.4 ft
SIZE	8"	0-60°	4608.81	96.3		10.0ft	87.6 fc	6.0 ft	5.8 ft
UGR	19.7	0-80°	4763.08	99.5		12.5ft	56.1 fc	7.5 ft	7.3 ft
		0-90°	4786.61	100		15.0ft	39 fc	9.0 ft	8.7 ft
						■ Vert. Spread: 33.3° ■ Horiz. Spread: 32.5°			

PART NUMBER		ZONAL LUMEN SUMMARY			POLAR LUMINOUS INTENSITY	CONE DISTRIBUTION			
AE-DL-GX-8R-50W		Zone	Lumens	% Fixture	Direct Light	Center Beam Fc	Beam Width		
Wattage	50W	0-20°	1254.66	27.9		2.5ft	644 fc	3.0 ft	3.0 ft
CCT	4000K	0-30°	2402.34	53.5		5.0ft	161 fc	6.0 ft	6.1 ft
Distribution	65°	0-40°	3452.94	76.8		7.5ft	71.5 fc	9.1 ft	9.1 ft
SIZE	8"	0-60°	4243.42	94.4		10.0ft	40.2 fc	12.1 ft	12.2 ft
UGR	21.1	0-80°	4454.83	99.1		12.5ft	25.7 fc	15.1 ft	15.2 ft
		0-90°	4493.15	100		15.0ft	17.9 fc	18.1 ft	18.3 ft
						■ Vert. Spread: 62.3° ■ Horiz. Spread: 62.7°			

LED COMMERCIAL DOWNLIGHT

Recessed Downlight | 4", 6", & 8" Round

Control Solution

Aria Plus Bluetooth based control system with motion sensor and light schedule Room Sensor

Refer to Lighting control (Aria) spec sheet for more information

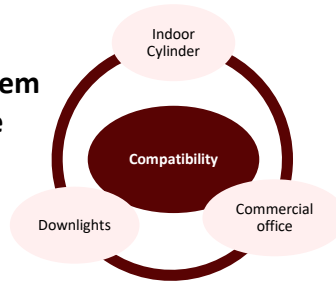

EFS107



PPA103S



It is a low-voltage, dual-tech ceiling mount room sensor that combines PIR and ultrasonic technologies to provide high accuracy and wide coverage.

Parameters	
Input Voltage	12V
Application	Indoor / Outdoor
Detection Range	50ft Max
Mounting Height	20ft Max
Bluetooth Transmit	200ft Max
Operating Temperature	-30°C to 55°C
IP Rating	IP66
Installation	Ceiling (2.2" cutout)
Detection	PIR DLH

Features	
Powered by luminaire controllers (PPA103S)	
Easily installed to any ceiling	
PIR technology	
Daylight harvesting available	
Schedule lighting	
On/off with dimming option	

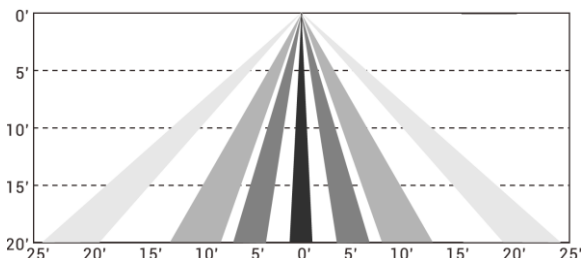

It is a power pack that provides 12V DC output to power sensors and switching for non-dim-to-off LED drivers. The PPA103S also provides a 0-10V dimming wire for bi-level motion control and relay output.

Parameters	
Input Voltage	120-347V
Output Power	360W
Application	Indoor
Bluetooth Transmit	200ft MAX
Operating Temperature	-30°C to 55°C
IP Rating	IP20
Installation	Flat Surface
Knockout	½ inch US standard

Features	
high-efficiency switching power supply and a 6A relay	
Well-suited for applications that require high-voltage switching through low voltage controls	
Offers 12VDC, 200mA to power the sensor	
Needs Sensor	
Can power up to 360W total power fixtures (ex: 10 of 36W fixtures)	

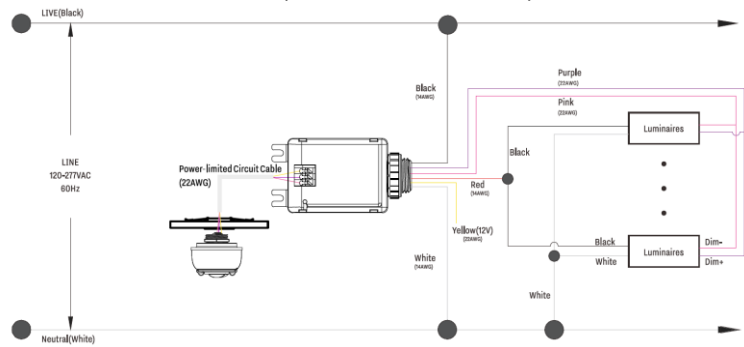

LED COMMERCIAL DOWNLIGHT

Recessed Downlight | 4", 6", & 8" Round

OVERVIEW



Innovative Design

- Aluminum die-cast heatsink
- Improved design extends LED and driver lifespan.
- Stainless steel spring-action clip.
- Quick connector for easy installation



Multiple Options



- Two power options; 30/24/18W and 50/40/30W.
- Three sizes; 4, 6 and 8inch
- Five CCTs switchable; 27/30/35/40/50K
- Adjustable beam angle; 24°-36°-60° for 30W
36°-42°-65° for 50W.
- Three reflector finishes; black, white, and matte silver.

Quick Connector

BX Cable

Seismic Bracing

Spring-Action Clip

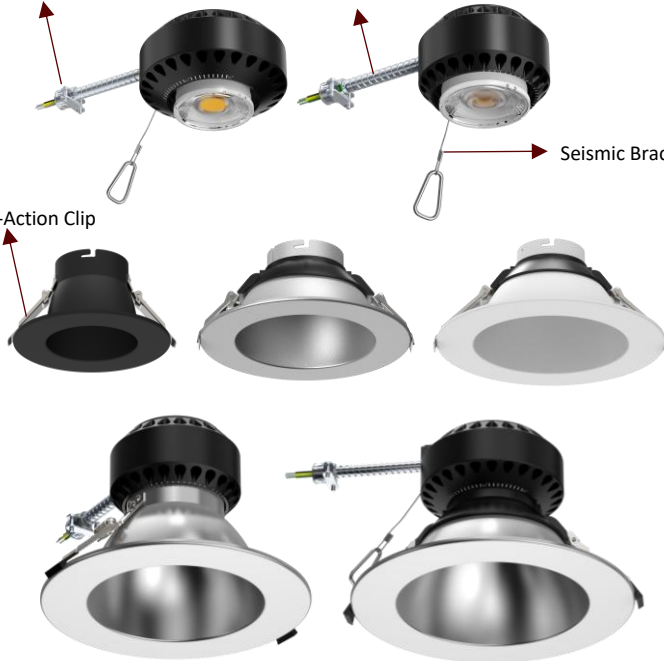

Mountings Available

Durable stainless steel spring action housing clips for retrofit installations or the new construction frame kit for new constructions.



Protection

- 2.5KV surge protector
- Wet rated suitable for wet locations, such as washrooms, kitchens.



Accessories

- New construction frame kit.
- Emergency back up battery.
- Compatible with Aria Plus – Bluetooth based control system



Tests And Certifications

