

## LED COMMERCIAL DOWNLIGHT

### Recessed Downlight | 4", 6", & 8" Round

The GALAXY is a recessed downlight offers a range of optical options. The variety of reflectors and trim finishes available makes it an attractive addition. It is available in multiple power switchable options 18/24/30W for 4" & 6" or 30/40/50W for 6" and 8" multiple CCTs and adjustable beam angles, with a low UGR of 16 or 19.

Applications: Schools | Show Rooms | Retail Stores | Hospitality | Offices | Commercial

	DATE	QTY	ACC. QTY	TYPE
PROJECT				
PN				
ACCESSORY PN				
NOTES				



### DYNAMIC MENU

Order Information	<a href="#">Page 2</a>
Dimensions	<a href="#">Page 4</a>
Accessories	<a href="#">Page 7</a>
Photometric Data	<a href="#">Page 10</a>

[Install Instruction link](#)

### SPECIFICATIONS

Input Voltage	120-277/347V
Power Factor	>0.9
Total Harmonic Distortion	<20%
Dimming <a href="#">Page 10</a>	0-10V (down to 10%)
CRI	90 CRI
CCT	<span style="background-color: #fff9c4; border-radius: 50%; padding: 2px 5px;">27K</span> <span style="background-color: #fff176; border-radius: 50%; padding: 2px 5px;">30K</span> <span style="background-color: #fff9c4; border-radius: 50%; padding: 2px 5px;">35K</span> <span style="background-color: #bbdefb; border-radius: 50%; padding: 2px 5px;">40K</span> <span style="background-color: #bbdefb; border-radius: 50%; padding: 2px 5px;">50K</span>
Efficacy	~70-100 lm/W
Size and Power	4 inch   18/24/30W 6 inch   18/24/30W   30/40/50W 8 inch   18/24/30W   30/40/50W
Ambient Temperature Range	-25°C to 40°C
Mounting Options	New construction   Retrofit
Reflector/Flange Finish	
Protection	Wet Rated; suitable for wet location 2.5KV Surge Protector
Adjustable beam angle	24°- 36°- 60° for 30W 36°- 42°- 65° for 50W
Distribution	



### PRODUCT FEATURES

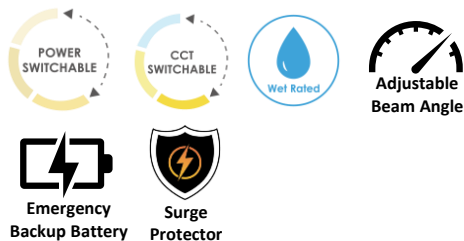

### PRODUCT CERTIFICATIONS



### SYSTEM WARRANTY – 5 YEARS

Eralux will warrant defective drivers, LEDs and boards for 5 years from the date of purchase. This warranty is valid only if the fixture is installed and used as per installation guides and specifications. If a defect is present, Eralux will send drivers and boards at no fee with a thorough replacement instructions along with instructions on the return of the defective parts back to Eralux.

### LUMEN MAINTENANCE – L70 at 50,000 hours

Rated for 70% initial lumen output at 50,000 hours of operation, operated at 25°C ambient temperature; per guidelines published by the Illuminating Engineering Society (IES).

## LED COMMERCIAL DOWNLIGHT

Recessed Downlight | 4", 6", & 8" Round



### ORDERING GUIDE

<b>AE-DL-GX</b>		<b>-275</b>		
<b>AE-DL-GX</b> ERALUX GALAXY Round Recessed Downlight  120-277/347V	<b>-4R   -30W</b> 4 inch   30/24/18W <b>-6R   -30W</b> 6 inch   30/24/18W <b>-6R   -50W</b> 6 inch   50/40/30W <b>-8R   -30W</b> 8 inch   30/24/18W <b>-8R   -50W</b> 8 inch   50/40/30W	<b>-275</b> 27/30/35/40/50K Switchable  90CRI	<b>-WHW</b> Matte White Reflector and Flange <b>-BKB</b> Matte Black Reflector and Flange <b>-SVS</b> Matte Silver Reflector and Flange	<b>[BLANK]</b> No Option <b>-JB<sup>1</sup></b> Separate Junction Box
<b>Fixture Family</b>	<b>Size   Power</b>	<b>CCT</b>	<b>Reflector   Flange Finish</b>	<b>Option</b>

**NOTES** 1. Junction Box is included with the frame kit.

Module	Input Voltage	Power	LPW	Lumens	Beam Angle	Dimming	IC Rating	Flange Size
<b>30W</b>	120-277/347V	30/24/18W	~70-100	2700/2400/1800lm	Adjustable 24° - 36° - 60°	0-10V (Down to 10%)	Non-IC rated	4   6   8 inch
<b>50W</b>		50/40/30W		4550/4000/3000lm	Adjustable 36° - 42° - 65°			6   8 inch

BEAM ANGLE	UGR
24°	<16
24°-42°	<19



### ORDERING GUIDE – FRAME KIT | EMBB

<b>AE-DL-FRKT</b> ERALUX FRAME KIT Round Downlights	<b>-05</b> 5 inch <b>-06</b> 6 inch <b>-08</b> 8 inch	<b>[BLANK]</b> No EMBB <b>BLD-HM8D-YYY</b> 8W Emergency Battery Backup
<b>Fixture Family</b>	<b>Size</b>	<b>EMBB</b>

**NOTES** 1. The 5 inch frame kit is compatible with the 4 inch Galaxy.  
2. Junction box is included with the frame kit.

## LED COMMERCIAL DOWNLIGHT

Recessed Downlight | 4", 6", & 8" Round

### LUMEN OUTPUT

	SIZE	POWER	BEAM ANGLE RANGE	LUMENS
WHITE REFLECTOR	4 IN	18W	24°-60°	1250-1550
		24W	24°-60°	1600-2025
		30W	24°-60°	2050-2340
	6 IN	18W	24°-60°	1355-1610
		24W	24°-60°	1763-2100
		30W	24°-60°	2080-2580
		30W	36°-65°	2680-3102
		40W	36°-65°	3430-3885
		50W	36°-65°	3986-4440
	8 IN	18W	24°-60°	1343-1595
		24W	24°-60°	1827-2050
		30W	24°-60°	2218-2662
		30W	36°-65°	2640-3049
		40W	36°-65°	3513-3895
		50W	36°-65°	4076-4796

LUMEN OUTPUT ADJUSTMENT FACTORS			
SIZE	4 in	6 in	8 in
BLACK REFLECTOR	0.84	0.88	
SILVER REFLECTOR			

## LED COMMERCIAL DOWNLIGHT

Recessed Downlight | 4", 6", & 8" Round

### DIMENSIONS

#### DRIVER & LIGHT ENGINE

**30W**

**50W**

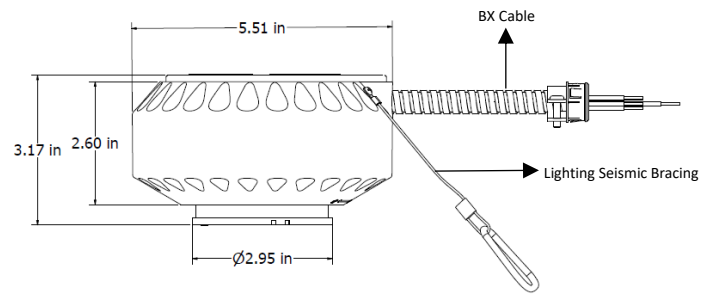
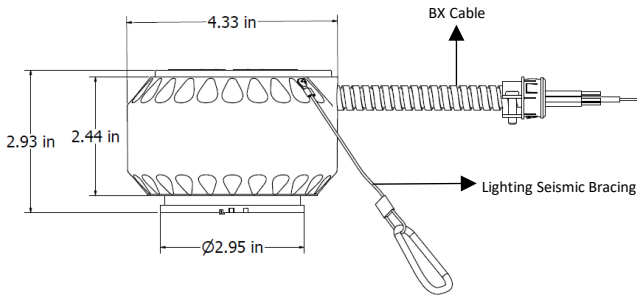

BX Cable length: 17 in – 18 in  
Lighting Seismic Bracing Length: 19 in

#### REFLECTOR

**4" ROUND**

**6" ROUND**

**8" ROUND**

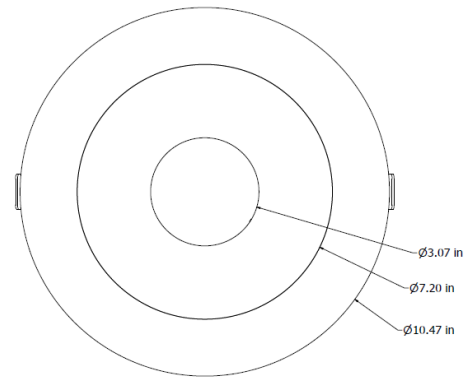
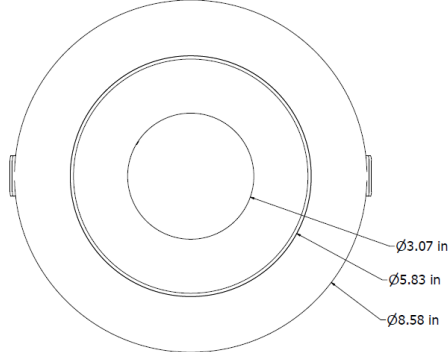
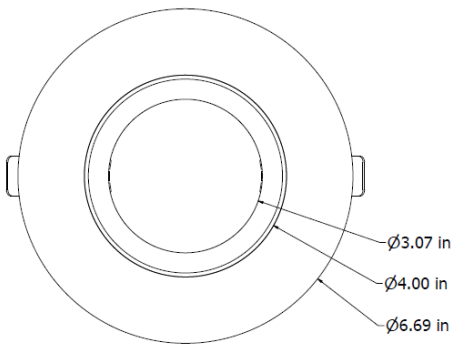
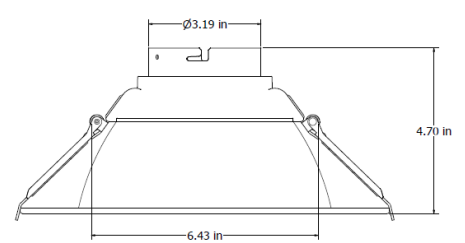
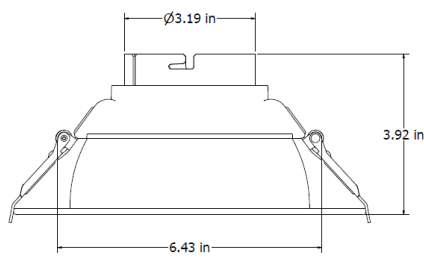
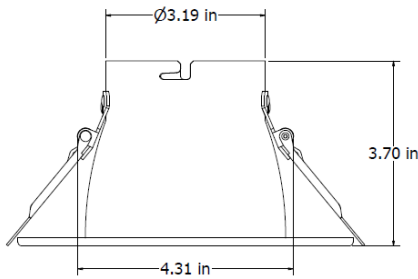

## LED COMMERCIAL DOWNLIGHT

Recessed Downlight | 4", 6", & 8" Round

### DIMENSIONS

#### FIXTURE

#### AE-DL-GX-4R-30W

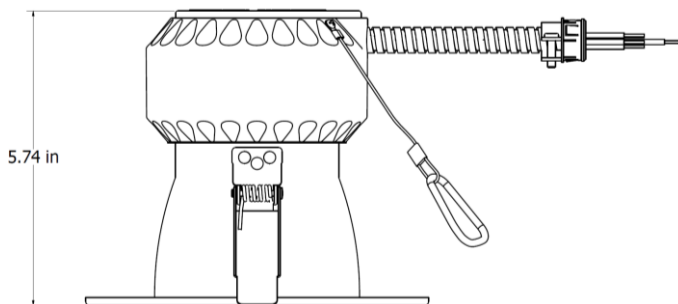

Ceiling cut-out:  
4.75 in  $\varnothing$

#### AE-DL-GX-6R-30W

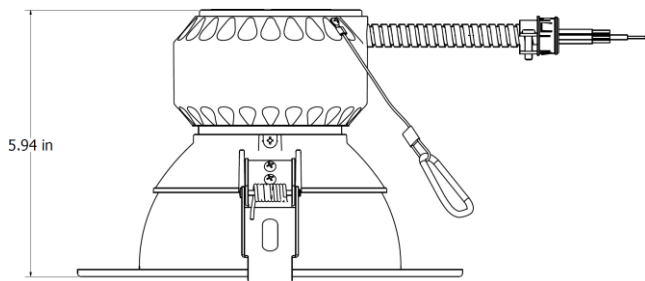

#### AE-DL-GX-6R-50W

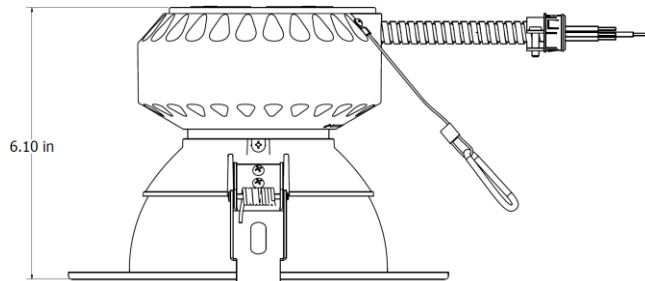

Ceiling cut-out:  
7 in  $\varnothing$

#### AE-DL-GX-8R-30W

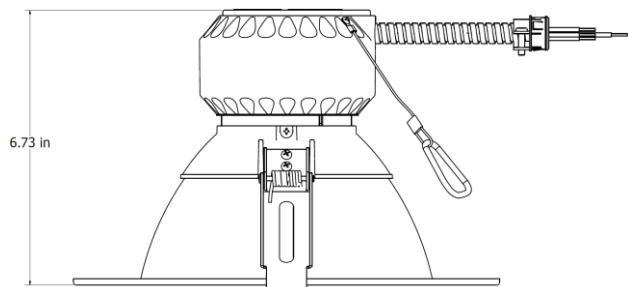

#### AE-DL-GX-8R-50W

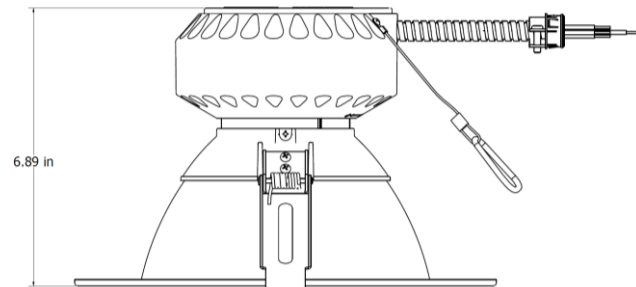

Ceiling cut-out:  
8 in  $\varnothing$

## LED COMMERCIAL DOWNLIGHT

Recessed Downlight | 4", 6", & 8" Round

### ADJUSTABLE BEAM ANGLE

#### DRIVER & LIGHT ENGINE

##### 30W

Adjustable beam angle to any value between 24°, 36° and 60°.  
Place the arrow at the desired angle by twisting the lens before installing the reflector

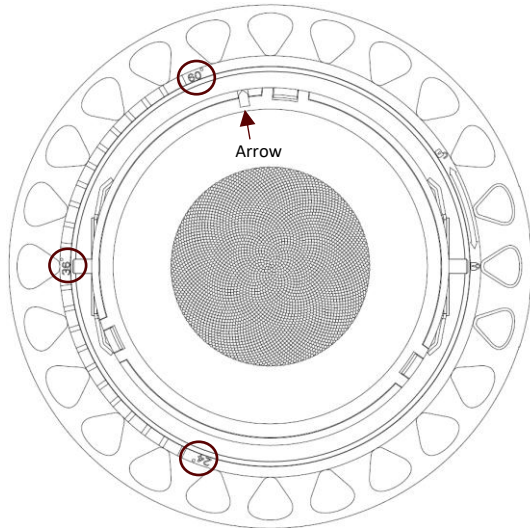

##### 50W

Adjustable beam angle to any value between 36°, 42° and 65°.  
Place the arrow at the desired angle by twisting the lens before installing the reflector

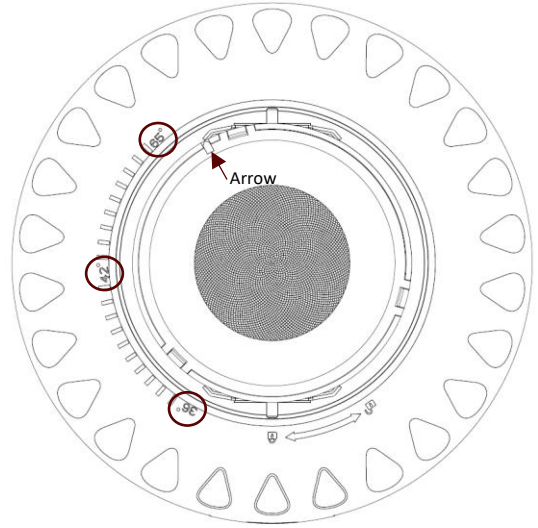

### REFLECTOR

#### FINISH

##### SHAPE

##### WHITE

##### DIFFUSED SILVER

##### BLACK

4-inch



6-inch



8-inch



##### DESCRIPTION

Maximizes and diffuses light, providing soft and even illumination.

Evenly scatters light, creating a soft, balanced illumination with reduced glare.

Absorbs light, creating a focused and dramatic effect with minimized glare.

## LED COMMERCIAL DOWNLIGHT

Recessed Downlight | 4", 6", & 8" Round

### MOUNTING ACCESSORIES

Ordered separately, field installed.

### NEW CONSTRUCTION FRAME KIT

SPECIFICATIONS	
<b>MATERIAL</b>	<ul style="list-style-type: none"> <li>22-gauge galvanized steel housing</li> <li>Galvanized steel junction box with multiple knockouts</li> </ul>
<b>MOUNTING</b>	T Grid Ceiling
	Gypsum Ceiling
	Maximum Thickness ~1.5"
<b>LENGTH (A)</b>	12.75"
<b>WIDTH (B)</b>	8.63"

OPENING SIZE			
ORDERING CODE	SIZE	SHAPE	C
AE-DL-FRKT-05	5"	Round	Ø 4.9"
AE-DL-FRKT-06	6"	Round	Ø 6.37"
AE-DL-FRKT-08	8"	Round	Ø 7.25"

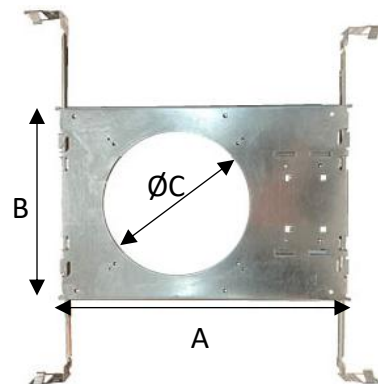

## LED COMMERCIAL DOWNLIGHT

Recessed Downlight | 4", 6", & 8" Round

### CONTROLS

Ordered separately, field installed

### EMERGENCY LED DRIVER (BLD-HMXXD-YYY)

BLD-HM8D-YYY



The BLD-HMXXD-YYY series LED Emergency Driver is UL listed for field and factory installations. It switches to emergency mode during power failures, providing up to 90 minutes of lighting. With an integrated battery, charger, and converter, it delivers 6-25W constant power at 170VDC. Ideal for 0-10V dimmable indoor commercial LED fixtures, such as flat panels, troffers, downlights, and linear strip lights.

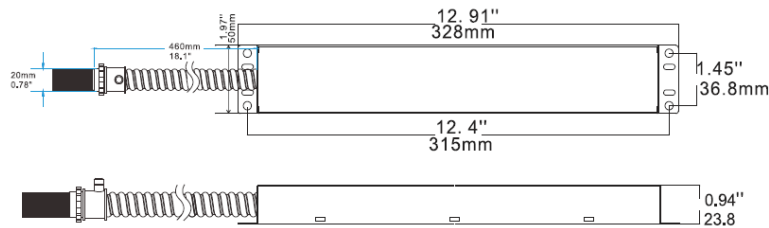

SPECIFICATIONS	
Input Voltage	100-347 Vac
Power Frequency	50/60HZ
Input Power	8W max
Output Voltage	170V Dc
Output Power	8W
Ambient Temperature	0°C to 50°C
	30°F to 122°F
Installation	Remote

### ROOM OCCUPANCY SENSOR

PART NUMBER	DESCRIPTION
AE-CT-DT806	Line Voltage Motion Sensor
RC102	RC102 Remote Control

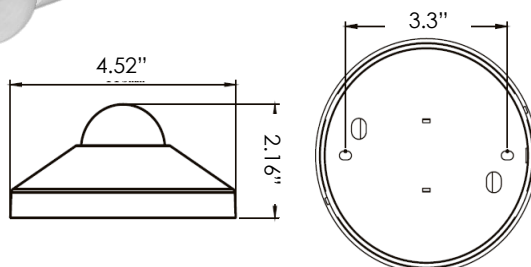

SPECIFICATIONS		
Input Voltage	120-277 Vac	
Power Frequency	50/60HZ	
Rated Load	At 120 Vac	800W
	At 277 Vac	1200W
Detection Range	3-10 Meters	
	9.8-32.8 Feet	
Standby Power	~0.9W	
Time Setting	10 sec to 30 min	
Light Control	10-2,000LUX	
Installation	Ceiling Mounted	

## LED COMMERCIAL DOWNLIGHT

Recessed Downlight | 4", 6", & 8" Round

### CONTROLS

#### ARIA PLUS

- Bluetooth-based control system with motion sensor and light schedule room sensor
- Refer to Aria spec sheet for more information

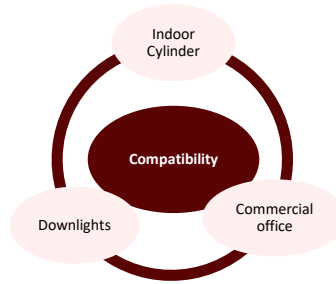

EFS107



PPA103S



EFS207 is a low-voltage, dual-tech ceiling mount room sensor that combines PIR and ultrasonic technologies to provide high accuracy and wide coverage.

PPA103S is a power pack that provides 12V DC output to power sensors and switching for non-dim-to-off LED drivers. The PPA103S also provides a 0-10V dimming wire for bi-level motion control and relay output.

#### Parameters

Input Voltage	12V
Application	Indoor / Outdoor
Detection Range	50ft Max
Mounting Height	20ft Max
Bluetooth Transmit	200ft Max
Operating Temperature	-30°C to 55°C
IP Rating	IP66
Installation	Ceiling (2.2" cutout)
Detection	PIR DLH

#### Parameters

Input Voltage	120-347V
Output Power	360W
Application	Indoor
Bluetooth Transmit	200ft MAX
Operating Temperature	-30°C to 55°C
IP Rating	IP20
Installation	Flat Surface
Knockout	½ inch US standard

#### Features

Powered by luminaire controllers (PPA103S)

Easily installed to any ceiling

PIR technology

Daylight harvesting available

Schedule lighting

On/off with dimming option

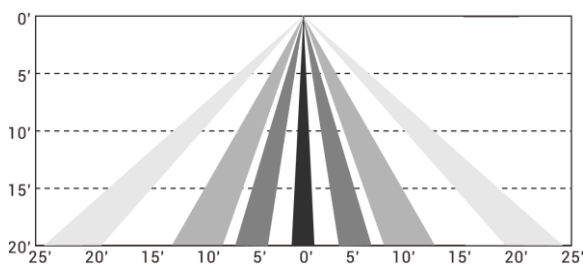

#### Features

high-efficiency switching power supply and a 6A relay

Well-suited for applications that require high-voltage switching through low voltage controls

Offers 12VDC, 200mA to power the sensor

#### Needs Sensor

Can power up to 360W total power fixtures (ex: 10 of 36W fixtures)

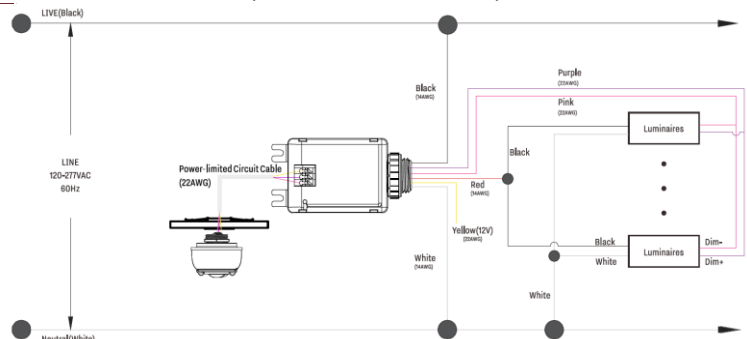

## LED COMMERCIAL DOWNLIGHT

Recessed Downlight | 4", 6", & 8" Round

### DIMMER COMPATIBILITY LIST

0-10V DIMMING

Brand	Model
LUTRON	RMJS-8TN-DV-B
	DVSTV-36WH29
	DVSTV-WH
LEGRAND	RH4FBL3PTCCCV6
	RH4FBL3PTC
LEVITON	IP710-LFZ

### LUMEN ESTIMATE

Lumen output varies based on CCT and CRI. Use correction factors as per table below:

#### LUMEN ESTIMATE ADJUSTMENT FACTORS

CCT	2700K	3000K	3500K	4000K
PREMIUM (90CRI)	0.94	1	1.02	1.03

### PHOTOMETRIC DATA

PART NUMBER		ZONAL LUMEN SUMMARY			POLAR LUMINOUS INTENSITY	CONE DISTRIBUTION			
AE-DL-GX-8R-30W		Zone	Lumens	% Fixture	Direct Light	Center Beam Fc	Beam Width		
Wattage	30W	0-20°	1457.61	55.6		2.5ft	1171 fc	1.3 ft	1.0 ft
CCT	2700K	0-30°	2017.32	77		5.0ft	293 fc	2.5 ft	1.9 ft
Distribution	24°	0-40°	2378.52	90.8		7.5ft	130 fc	3.8 ft	2.9 ft
SIZE	8"	0-60°	2562.68	97.8		10.0ft	73.2 fc	5.0 ft	3.9 ft
UGR	12.4	0-80°	2608.59	99.6		12.5ft	46.8 fc	6.3 ft	4.8 ft
		0-90°	2619.61	100		15.0ft	32.5 fc	7.6 ft	5.8 ft
						<span style="color: blue;">■</span> Vert. Spread: 28.3° <span style="color: red;">■</span> Horiz. Spread: 21.9°			

PART NUMBER		ZONAL LUMEN SUMMARY			POLAR LUMINOUS INTENSITY	CONE DISTRIBUTION			
AE-DL-GX-8R-30W		Zone	Lumens	% Fixture	Direct Light	Center Beam Fc	Beam Width		
Wattage	30W	0-20°	697.29	31.9		2.5ft	342 fc	3.0 ft	3.3 ft
CCT	2700K	0-30°	1329.96	60.8		5.0ft	85.4 fc	6.1 ft	6.5 ft
Distribution	60°	0-40°	1833.5	83.8		7.5ft	38 fc	9.1 ft	9.8 ft
SIZE	8"	0-60°	2096.86	95.9		10.0ft	21.4 fc	12.2 ft	13.1 ft
UGR	16.6	0-80°	2173.74	99.4		12.5ft	13.7 fc	15.2 ft	16.3 ft
		0-90°	2187.04	100		15.0ft	9.49 fc	18.3 ft	19.6 ft
						<span style="color: blue;">■</span> Vert. Spread: 62.7° <span style="color: red;">■</span> Horiz. Spread: 66.3°			

## LED COMMERCIAL DOWNLIGHT

Recessed Downlight | 4", 6", & 8" Round

### PHOTOMETRIC DATA

PART NUMBER		ZONAL LUMEN SUMMARY			POLAR LUMINOUS INTENSITY	CONE DISTRIBUTION			
AE-DL-GX-4R-30W		Zone	Lumens	% Fixture	Direct Light	Center Beam Fc	Beam Width		
Wattage	30W	0-20°	1206.72	52.3		2.5ft	1234 fc	1.3 ft	0.8 ft
CCT	4000K	0-30°	1735.72	75.2		5.0ft	309 fc	2.5 ft	1.7 ft
Distribution	24°	0-40°	2048.22	88.8		7.5ft	137 fc	3.8 ft	2.5 ft
SIZE	4"	0-60°	2213.54	95.9		10.0ft	77.1 fc	5.0 ft	3.4 ft
UGR	15.8	0-80°	2288.18	99.2		12.5ft	49.4 fc	6.3 ft	4.2 ft
		0-90°	2307.79	100		15.0ft	34.3 fc	7.6 ft	5.1 ft
						■ Vert. Spread: 28.3° ■ Horiz. Spread: 19.3°			

PART NUMBER		ZONAL LUMEN SUMMARY			POLAR LUMINOUS INTENSITY	CONE DISTRIBUTION			
AE-DL-GX-4R-30W		Zone	Lumens	% Fixture	Direct Light	Center Beam Fc	Beam Width		
Wattage	30W	0-20°	678.09	36.4		2.5ft	320 fc	2.8 ft	2.7 ft
CCT	4000K	0-30°	1219.32	65.4		5.0ft	80.1 fc	5.6 ft	5.3 ft
Distribution	60°	0-40°	1515.69	81.3		7.5ft	35.6 fc	8.4 ft	8.0 ft
SIZE	4"	0-60°	1732	92.9		10.0ft	20 fc	11.2 ft	10.6 ft
UGR	20	0-80°	1847.87	99.1		12.5ft	12.8 fc	14.0 ft	13.3 ft
		0-90°	1864.44	100		15.0ft	8.9 fc	16.8 ft	15.9 ft
						■ Vert. Spread: 58.5° ■ Horiz. Spread: 56.0°			

PART NUMBER		ZONAL LUMEN SUMMARY			POLAR LUMINOUS INTENSITY	CONE DISTRIBUTION			
AE-DL-GX-8R-50W		Zone	Lumens	% Fixture	Direct Light	Center Beam Fc	Beam Width		
Wattage	50W	0-20°	1939.17	40.5		2.5ft	1402 fc	1.5 ft	1.5 ft
CCT	4000K	0-30°	3088.35	64.5		5.0ft	351 fc	3.0 ft	2.9 ft
Distribution	36°	0-40°	3999.09	83.5		7.5ft	156 fc	4.5 ft	4.4 ft
SIZE	8"	0-60°	4608.81	96.3		10.0ft	87.6 fc	6.0 ft	5.8 ft
UGR	19.7	0-80°	4763.08	99.5		12.5ft	56.1 fc	7.5 ft	7.3 ft
		0-90°	4786.61	100		15.0ft	39 fc	9.0 ft	8.7 ft
						■ Vert. Spread: 33.3° ■ Horiz. Spread: 32.5°			

PART NUMBER		ZONAL LUMEN SUMMARY			POLAR LUMINOUS INTENSITY	CONE DISTRIBUTION			
AE-DL-GX-8R-50W		Zone	Lumens	% Fixture	Direct Light	Center Beam Fc	Beam Width		
Wattage	50W	0-20°	1254.66	27.9		2.5ft	644 fc	3.0 ft	3.0 ft
CCT	4000K	0-30°	2402.34	53.5		5.0ft	161 fc	6.0 ft	6.1 ft
Distribution	65°	0-40°	3452.94	76.8		7.5ft	71.5 fc	9.1 ft	9.1 ft
SIZE	8"	0-60°	4243.42	94.4		10.0ft	40.2 fc	12.1 ft	12.2 ft
UGR	21.1	0-80°	4454.83	99.1		12.5ft	25.7 fc	15.1 ft	15.2 ft
		0-90°	4493.15	100		15.0ft	17.9 fc	18.1 ft	18.3 ft
						■ Vert. Spread: 62.3° ■ Horiz. Spread: 62.7°			

## LED COMMERCIAL DOWNLIGHT

Recessed Downlight | 4", 6", & 8" Round

### PHOTOMETRIC DATA

PART NUMBER		ZONAL LUMEN SUMMARY			POLAR LUMINOUS INTENSITY	CONE DISTRIBUTION			
AE-DL-GX-6R-30W		Zone	Lumens	% Fixture	Direct Light	Center Beam Fc	Beam Width		
Wattage	30W	0-20°	1521.17	52.9		2.5ft	1366 fc	1.2 ft	1.1 ft
CCT	5000K	0-30°	2144.91	74.6		5.0ft	342 fc	2.4 ft	2.2 ft
Distribution	24°	0-40°	2561.36	89.1		7.5ft	152 fc	3.6 ft	3.2 ft
SIZE	6"	0-60°	2804.64	97.5		10.0ft	85.4 fc	4.8 ft	4.3 ft
UGR	12.8	0-80°	2860.26	99.5		12.5ft	54.6 fc	6.0 ft	5.4 ft
		0-90°	2875.41	100		15.0ft	37.9 fc	7.2 ft	6.5 ft
						<span style="color:blue">■</span> Vert. Spread: 27.2° <span style="color:red">■</span> Horiz. Spread: 24.4°			

PART NUMBER		ZONAL LUMEN SUMMARY			POLAR LUMINOUS INTENSITY	CONE DISTRIBUTION			
AE-DL-GX-6R-30W		Zone	Lumens	% Fixture	Direct Light	Center Beam Fc	Beam Width		
Wattage	30W	0-20°	706.4	30.7		2.5ft	323 fc	3.3 ft	3.3 ft
CCT	5000K	0-30°	1369.28	59.5		5.0ft	80.8 fc	6.7 ft	6.6 ft
Distribution	60°	0-40°	1895.57	82.3		7.5ft	35.9 fc	10.0 ft	9.9 ft
SIZE	6"	0-60°	2179.16	94.6		10.0ft	20.2 fc	13.4 ft	13.2 ft
UGR	17.5	0-80°	2281.93	99.1		12.5ft	12.9 fc	16.7 ft	16.6 ft
		0-90°	2303.14	100		15.0ft	8.97 fc	20.1 ft	19.9 ft
						<span style="color:blue">■</span> Vert. Spread: 67.6° <span style="color:red">■</span> Horiz. Spread: 67.0°			

PART NUMBER		ZONAL LUMEN SUMMARY			POLAR LUMINOUS INTENSITY	CONE DISTRIBUTION			
AE-DL-GX-6R-50W		Zone	Lumens	% Fixture	Direct Light	Center Beam Fc	Beam Width		
Wattage	50W	0-20°	1811.63	38.9		2.5ft	1246 fc	1.5 ft	1.4 ft
CCT	5000K	0-30°	2910.61	62.5		5.0ft	311 fc	3.0 ft	2.8 ft
Distribution	36°	0-40°	3801.12	81.6		7.5ft	138 fc	4.5 ft	4.2 ft
SIZE	6"	0-60°	4463.35	95.8		10.0ft	77.9 fc	6.1 ft	5.5 ft
UGR	19.5	0-80°	4631.05	99.4		12.5ft	49.8 fc	7.6 ft	6.9 ft
		0-90°	4658.62	100		15.0ft	34.6 fc	9.1 ft	8.3 ft
						<span style="color:blue">■</span> Vert. Spread: 33.7° <span style="color:red">■</span> Horiz. Spread: 30.9°			

PART NUMBER		ZONAL LUMEN SUMMARY			POLAR LUMINOUS INTENSITY	CONE DISTRIBUTION			
AE-DL-GX-6R-50W		Zone	Lumens	% Fixture	Direct Light	Center Beam Fc	Beam Width		
Wattage	50W	0-20°	1153.73	27.6		2.5ft	579 fc	3.1 ft	3.5 ft
CCT	5000K	0-30°	2226.48	53.3		5.0ft	145 fc	6.3 ft	7.0 ft
Distribution	65°	0-40°	3201.29	76.7		7.5ft	64.3 fc	9.4 ft	10.4 ft
SIZE	6"	0-60°	3921.45	93.9		10.0ft	36.2 fc	12.5 ft	13.9 ft
UGR	21.4	0-80°	4141.2	99.2		12.5ft	23.2 fc	15.7 ft	17.4 ft
		0-90°	4175.62	100		15.0ft	16.1 fc	18.8 ft	20.9 ft
						<span style="color:blue">■</span> Vert. Spread: 64.2° <span style="color:red">■</span> Horiz. Spread: 69.6°			

## LED COMMERCIAL DOWNLIGHT

Recessed Downlight | 4", 6", & 8" Round

### OVERVIEW



#### Innovative Design

- Aluminum die-cast heatsink
- Improved design extends LED and driver lifespan.
- Stainless steel spring-action clip.
- Quick connector for easy installation



#### Multiple Options

- Two power options: 30/24/18W and 50/40/30W.
- Three sizes: 4, 6 and 8inch
- Five CCTs switchable: 27/30/35/40/50K
- Adjustable beam angle: 24°-36°-60° for 30W  
36°-42°-65° for 50W.
- Three reflector finishes: black, white, and matte silver.

Quick Connector

BX Cable

Seismic Bracing

Spring-Action Clip

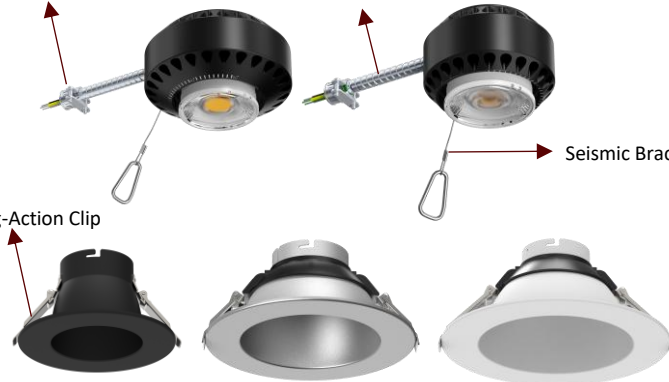

#### Mountings Available

Durable stainless steel spring action housing clips for retrofit installations or the new construction frame kit for new constructions.



#### Protection

- 2.5KV surge protector
- Wet rated suitable for wet locations, such as washrooms, kitchens.



#### Accessories

- New construction frame kit.
- Emergency back up battery.
- Compatible with Aria Plus – Bluetooth-based control system



#### Tests And Certifications

