

GUARDIANS

eralux®

LED COMMERCIAL DOWNLIGHT

Recessed High Output Downlight | 4", 5" & 6" Round

The GUARDIANS series is designed for easy installation with a spring and roto-lock mechanism, making it ideal for both retrofits and new construction. Its durable aluminum housing ensures long-lasting reliability. Offering a variety of lumen outputs and CCT options, this series provides exceptional flexibility. The wide beam angle and high lumen output make it an excellent choice for illuminating large, high-ceiling spaces.

Applications: Art Galleries | Show Rooms | Retail Stores | Hotel Lobbies

	DATE	QTY	ACC. QTY	TYPE
PROJECT				
PN				
ACCESSORY PN				
NOTES				



DYNAMIC MENU

Order Information	Page 2
Dimensions	Page 3
Accessories	Page 4
Photometric Data	Page 7

[Install Instruction link](#)

SPECIFICATIONS

Input Voltage	120-277V						
Power Factor	>0.9						
Total Harmonic Distortion	<20%						
Dimming	TRIAC & 0-10V dimming (down 10%)						
UGR	Low glare UGR<16						
CRI	90 CRI						
CCT	<div style="display: flex; gap: 10px;"> <div style="background-color: #fff9c4; border-radius: 50%; padding: 2px 5px;">27K</div> <div style="background-color: #fff176; border-radius: 50%; padding: 2px 5px;">30K</div> <div style="background-color: #fff9c4; border-radius: 50%; padding: 2px 5px;">35K</div> <div style="background-color: #bbdefb; border-radius: 50%; padding: 2px 5px;">40K</div> <div style="background-color: #b3e5fc; border-radius: 50%; padding: 2px 5px;">50K</div> </div>						
Efficacy	~80-90 lm/W						
Size and Power	<table border="0"> <tr> <td>4"</td> <td>20 25W</td> </tr> <tr> <td>5"</td> <td>20 25 30 35W</td> </tr> <tr> <td>6"</td> <td>20 25 30 35 40 45W</td> </tr> </table>	4"	20 25W	5"	20 25 30 35W	6"	20 25 30 35 40 45W
4"	20 25W						
5"	20 25 30 35W						
6"	20 25 30 35 40 45W						
Ambient Temperature Range	-20°C to 40°C						
Mounting Options	New construction Retrofit						
Reflector Finish							
Trim Shape							
Trim Finish							
Distribution							



PRODUCT FEATURE



PRODUCT CERTIFICATIONS



SYSTEM WARRANTY – 5 YEARS

Eralux will warrant defective drivers, LEDs and boards for 5 years from the date of purchase. This warranty is valid only if the fixture is installed and used as per installation guides and specifications. If a defect is present, Eralux will send drivers and boards at no fee with a thorough replacement instructions along with instructions on the return of the defective parts back to Eralux.

LUMEN MAINTENANCE – L85 at 50,000 hours

Rated for 85% initial lumen output at 50,000 hours of operation, operated at 25°C ambient temperature; per guidelines published by the Illuminating Engineering Society (IES).

LED COMMERCIAL DOWNLIGHT

Recessed High-Output Downlight | 4", 5" & 6" Round



ORDERING GUIDE

AE-DL-GR			-X			
AE-DL-GR ERALUX Guardians Series LED Commercial Downlight	-4-UV-20W 4" 20W 1694 lm	-WH White	-X Dual dimming: 0-10V & TRIAC Dimming	P27 2700K	24 24°	BK Black Finish
	-4-UV-25W 4" 25W 2190 lm	-BK Black		P30 3000K	38 38°	WH White Finish
	-5-UV-20W 5" 20W 1694 lm	-GD Gold		P35 3500K	60 60°	
	-5-UV-25W 5" 25W 2190 lm	-DF Diffused Matte Silver		P40 4000K		
	-5-UV-30W 5" 30W 2441 lm	-SP Specular Bright Silver		P50 5000K		
	-5-UV-35W 5" 35W 3016 lm					
	-6-UV-20W 6" 20W 1694 lm					
	-6-UV-25W 6" 25W 2190 lm					
	-6-UV-30W 6" 30W 2441 lm					
	-6-UV-35W 6" 35W 3016 lm					
	-6-UV-40W 6" 40W 3600 lm					
	-6-UV-45W 6" 45W 4056 lm					

Fixture Family	Size Power	Reflector Finish	Controls	CCT	Distribution	Trim Finish
----------------	--------------	------------------	----------	-----	--------------	-------------

* Only 20W & 25W options are IC Rated



ORDERING GUIDE – FRAME KIT | EMBB

AE-DL-FRKT			
AE-DL-FRKT ERALUX Frame Kits Downlights	-04 4 Inches	-UNV¹ Universal	[BLANK] No EMBB
	-05 5 Inches	-PPF³ Plaster Frame Plate	BLD-HM8D-YYY 8W Emergency Battery Backup
	-06 6 Inches		EMBB
Fixture Family	Size	Type	

- Junction Box is not included. Guardian Series comes with a junction box by default.
- Chicago Plenum available for 4 and 6 inches.
- Plaster Frame Plate option available for 4 and 6 inches.

LED COMMERCIAL DOWNLIGHT

Recessed High-Output Downlight | 4", 5" & 6" Round

DIMENSIONS

FIXTURE			
	Guardians 4"	Guardians 5"	Guardians 6"
A	Ø 4.65 in	Ø 5.63 in	Ø 6.61 in
B	Ø 3.66 in	Ø 4.72 in	Ø 5.64 in
C	3.25 in	3.54 in	4.33 in
D	Ø 3.86 in	Ø 4.84 in	Ø 5.83 in
E	Ø 3.9-4.1 in	Ø 4.9-5.1 in	Ø 5.9-6.1 in



Ceiling cut-out: E

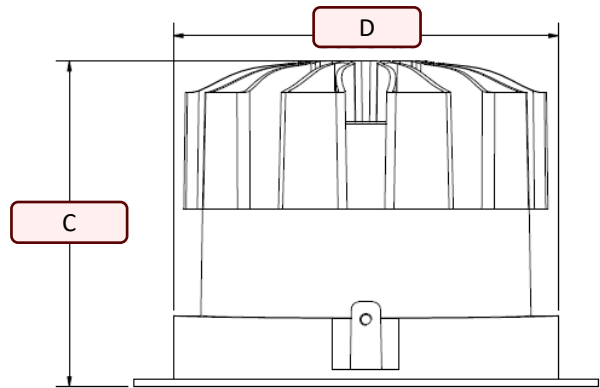
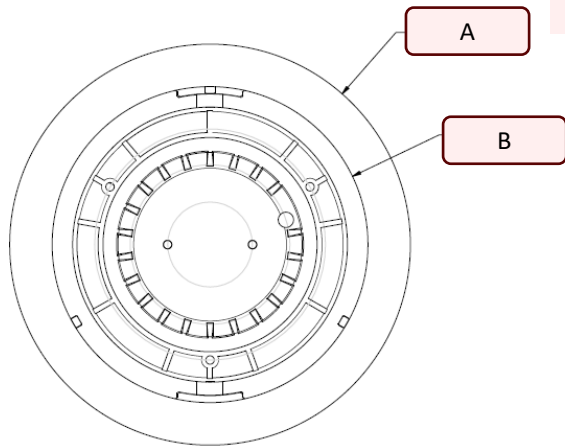

DRIVER

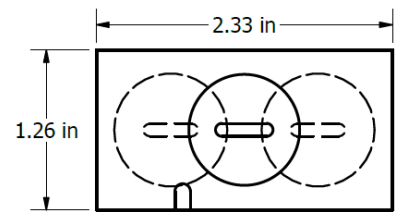
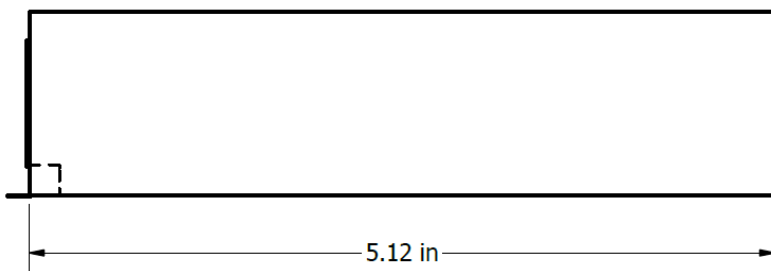

CEILING THICKNESS

4 inch - SPRING MECHANISM

5/6 inch - ROTO-LOCK MECHANISM



LED COMMERCIAL DOWNLIGHT

Recessed High-Output Downlight | 4", 5" & 6" Round

REFLECTOR FINISH



Gold



Diffused
Matte Silver



Black

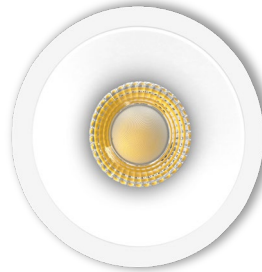

White



Specular
Bright Silver

TRIM FINISH



Black

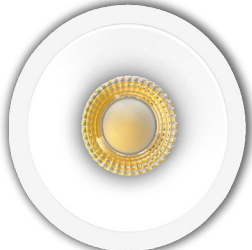

White

FIXING MECHANISM

4 inch - SPRING MECHANISM



Spring clips snapping over the ceiling for simple installation and easy readjustments.

5/6 inch - ROTO-LOCK MECHANISM



Roto-lock mechanism for a rigid fixation on the ceiling simply by tightening the two screws under the reflector.

LED COMMERCIAL DOWNLIGHT

Recessed High-Output Downlight | 4", 5" & 6" Round

MOUNTING ACCESSORIES

Ordered separately, field installed.

NEW CONSTRUCTION UNIVERSAL FRAME KIT

SPECIFICATIONS			
MATERIAL	22-gauge galvanized steel housing		
MOUNTING	T-bar or drywall ceilings Up to 1.5" thick		
LENGTH (A)	12.75 inch		
WIDTH (B)	8.63 inch		
OPENING SIZE			
ORDERING CODE	SIZE	SHAPE	C
AE-DL-FRKT-04-UNV	4"	Round	4.20" Ø
AE-DL-FRKT-05-UNV	5"	Round	4.92" Ø
AE-DL-FRKT-06-UNV	6"	Round	6.37" Ø

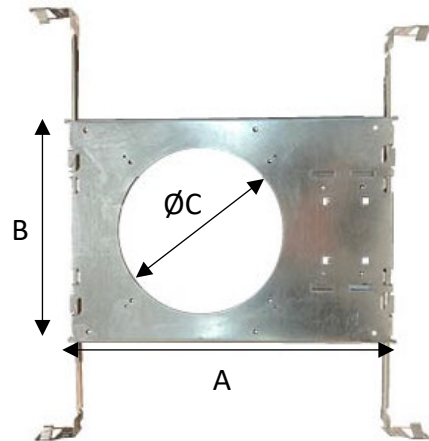

NEW CONSTRUCTION PLASTER FRAME PLATE

SPECIFICATIONS			
MATERIAL	22-gauge galvanized steel housing		
MOUNTING	T-bar or drywall ceilings Up to 1.5" thick		
LENGTH (A)	12.087 inch		
WIDTH (B)	7.625 inch		
OPENING SIZE			
ORDERING CODE	SIZE	SHAPE	A
AE-DL-FRKT-04-PFP	4"	Round	4.30" Ø
AE-DL-FRKT-06-PFP	6"	Round	6.25" Ø

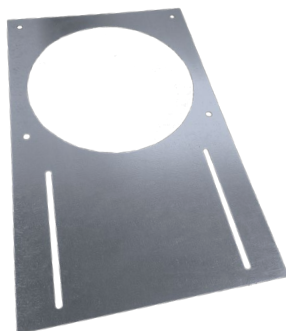
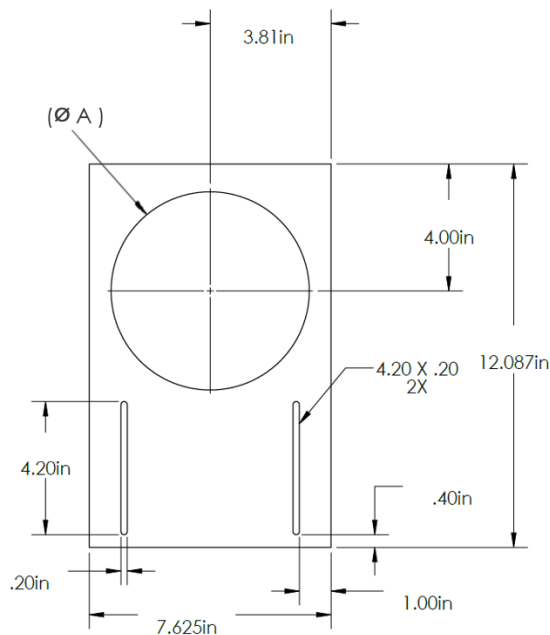

LED COMMERCIAL DOWNLIGHT

Recessed High-Output Downlight | 4", 5" & 6" Round

CONTROLS

Ordered separately, field installed

EMERGENCY LED DRIVER (BLD-HMXXD-YYY)

BLD-HM8D-YYY



The BLD-HMXXD-YYY series LED Emergency Driver is UL listed for field and factory installations. It switches to emergency mode during power failures, providing up to 90 minutes of lighting. With an integrated battery, charger, and converter, it delivers 6-25W constant power at 170VDC. Ideal for 0-10V dimmable indoor commercial LED fixtures, such as flat panels, troffers, downlights, and linear strip lights.

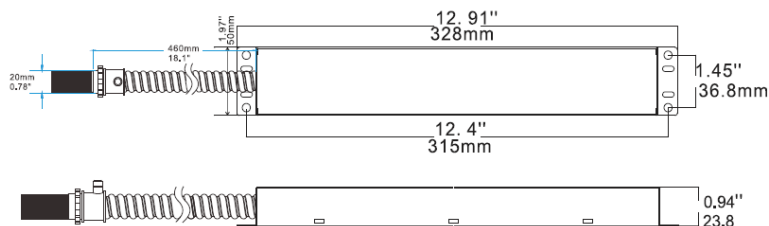

SPECIFICATIONS	
Input Voltage	100-347 Vac
Power Frequency	50/60HZ
Input Power	8W max
Output Voltage	170V Dc
Output Power	8W
Ambient Temperature	0°C to 50°C
	30°F to 122°F
Installation	Remote

ROOM OCCUPANCY SENSOR

PART NUMBER	DESCRIPTION
AE-CT-DT806	Detecta - Room Occupancy Sensor

RC102	RC102 Remote Control
-------	----------------------

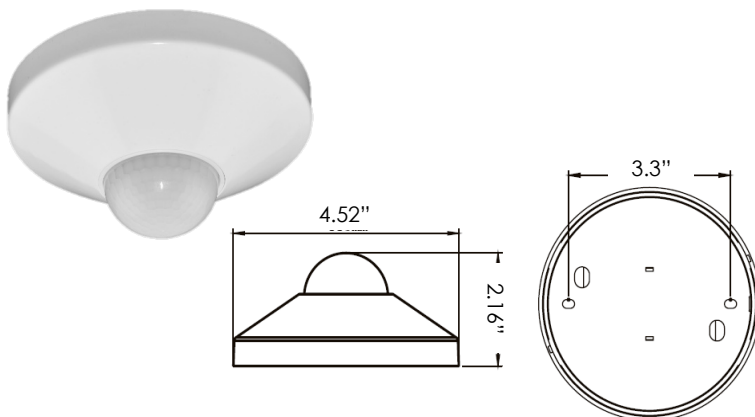

SPECIFICATIONS	
Input Voltage	120-277 Vac
Power Frequency	50/60HZ
Rated Load	At 120 Vac 800W
	At 277 Vac 1200W
Detection Range	3-10 Meters
	9.8- 32.8 Feet
Standby Power	~0.9W
Time Setting	10 sec to 30 min
Light Control	10-2,000LUX
Installation	Ceiling Mounted

LED COMMERCIAL DOWNLIGHT

Recessed High-Output Downlight | 4", 5" & 6" Round

LUMENS ESTIMATE

Lumen output varies based on CCT and CRI. An estimate of lumen output of the various CCT/CRI combinations, use correction factors as per table below:

LUMEN ESTIMATE ADJUSTMENT FACTORS				
CCT	2700K	3000K	3500K	4000K
PREMIUM (90CRI)	0.96	1	1.03	1.06

PHOTOMETRIC DATA

PART NUMBER		ZONAL LUMEN SUMMARY			POLAR LUMINOUS INTENSITY	CONE DISTRIBUTION			
AE-DL-GR-4		Zone	Lumens	% Fixture	Direct Light	Center Beam Fc	Beam Width		
Wattage	20W	0-20°	1262.8	67.3		2.5ft	1113 fc	1.1 ft	1.1 ft
CCT	3000K	0-30°	1587.42	84.6		5.0ft	278 fc	2.2 ft	2.2 ft
Distribution	24°	0-40°	1751	93.3		7.5ft	124 fc	3.4 ft	3.4 ft
SIZE	4"	0-60°	1829	97.5		10.0ft	69.6 fc	4.5 ft	4.5 ft
		0-80°	1830.05	97.6		12.5ft	44.5 fc	5.6 ft	5.6 ft
		0-90°	1830.37	97.6		15.0ft	30.9 fc	6.7 ft	6.7 ft
						■ Vert. Spread: 25.2° ■ Horiz. Spread: 25.2°			

PART NUMBER		ZONAL LUMEN SUMMARY			POLAR LUMINOUS INTENSITY	CONE DISTRIBUTION			
AE-DL-GR-4		Zone	Lumens	% Fixture	Direct Light	Center Beam Fc	Beam Width		
Wattage	25W	0-20°	1489.71	67.4		2.5ft	1679 fc	1.2 ft	1.2 ft
CCT	3000K	0-30°	1871.48	84.6		5.0ft	420 fc	2.4 ft	2.4 ft
Distribution	24°	0-40°	2064.2	93.3		7.5ft	187 fc	3.6 ft	3.6 ft
SIZE	4"	0-60°	2155.92	97.5		10.0ft	105 fc	4.8 ft	4.8 ft
		0-80°	2157.14	97.5		12.5ft	67.2 fc	6.1 ft	6.0 ft
		0-90°	2157.51	97.6		15.0ft	46.6 fc	7.3 ft	7.2 ft
						■ Vert. Spread: 27.3° ■ Horiz. Spread: 27.0°			

PART NUMBER		ZONAL LUMEN SUMMARY			POLAR LUMINOUS INTENSITY	CONE DISTRIBUTION			
AE-DL-GR-5		Zone	Lumens	% Fixture	Direct Light	Center Beam Fc	Beam Width		
Wattage	30W	0-20°	2059.45	67.6		2.5ft	1679 fc	1.2 ft	1.2 ft
CCT	4000K	0-30°	2595.93	85.3		5.0ft	420 fc	2.4 ft	2.4 ft
Distribution	24°	0-40°	2838.94	93.2		7.5ft	187 fc	3.6 ft	3.6 ft
SIZE	5"	0-60°	2968.7	97.5		10.0ft	105 fc	4.8 ft	4.8 ft
		0-80°	2970.31	97.5		12.5ft	67.2 fc	6.1 ft	6.0 ft
		0-90°	2970.83	97.6		15.0ft	46.6 fc	7.3 ft	7.2 ft
						■ Vert. Spread: 27.3° ■ Horiz. Spread: 27.0°			

LED COMMERCIAL DOWNLIGHT

Recessed High-Output Downlight | 4", 5" & 6" Round

PHOTOMETRIC DATA

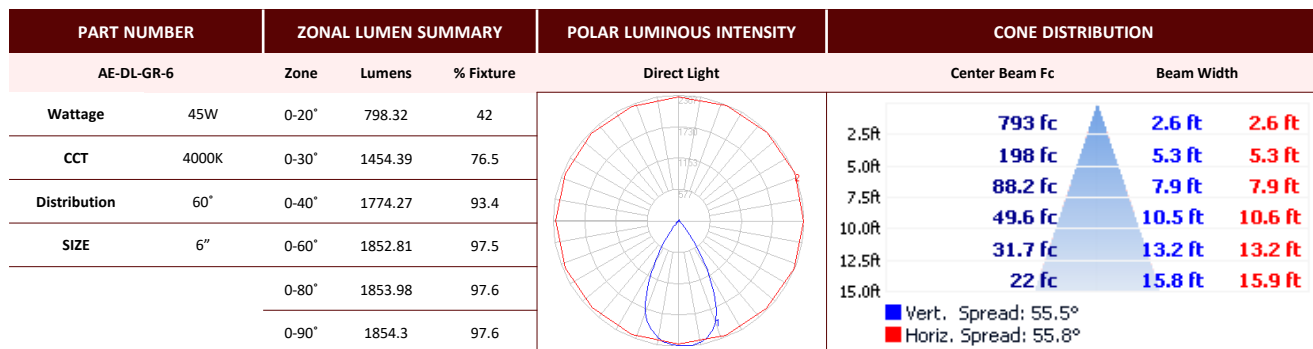
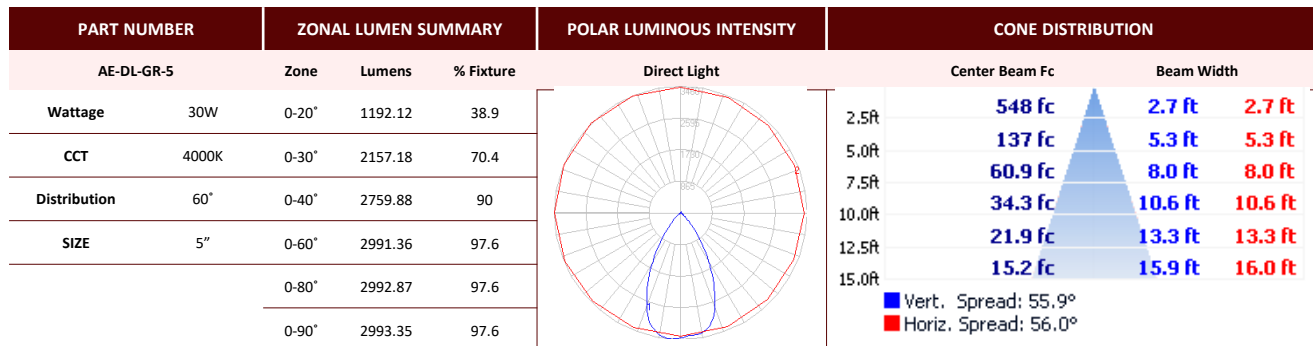
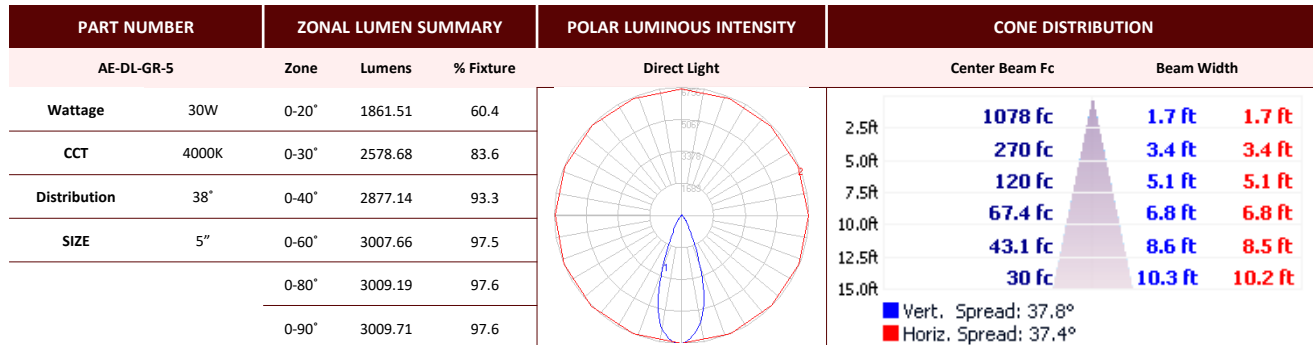

LED COMMERCIAL DOWNLIGHT

Recessed High-Output Downlight | 4", 5" & 6" Round

OVERVIEW



Protection

- IP54 & IC RATED (limited powers)
- Suitable for semi-outdoor and wet areas, and safe to be in contact with insulation



Multiple Options

- Three sizes: 4", 5", and 6"
- Five CCT options from 2700K to 5000K
- Three distributions: 24°, 38° and 60°
- Two trim colors
- Five reflector finishes



Accessories

- New construction frame kit.
- Emergency back up battery.

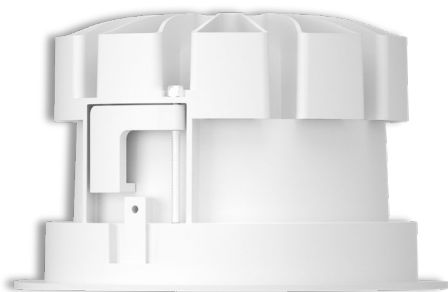

Tests And Certifications



Emergency Backup Battery

IC RATED POWER

20W

25W