

TRACK T1

TRACK ACCESSORIES AND SYSTEMS

ERALUX Track 1 is compatible with Juno single circuit Adapters (Juno is a brand of ACUITY). Track and power distribution system is suitable for retail, commercial and residential use. Ships with one end cap (T0009) installed extruded aluminum "I" beam. Thermoplastic insulator. Two #12 AWG solid copper conductors.

eralux®

	DATE	QTY	ACC. QTY	TYPE
PROJECT				
PN				
ACCESSORY PN				
NOTES				



PRODUCT CERTIFICATIONS



SYSTEM WARRANTY – 3 YEARS

Eralux will warrant defective drivers, LEDs and boards for 3 years from the date of purchase. This warranty is valid only if the fixture is installed and used as per installation guides and specifications. If a defect is present, Eralux will send drivers and boards at no fee with a thorough replacement instructions along with instructions on the return of the defective parts back to Eralux.

ORDERING GUIDE

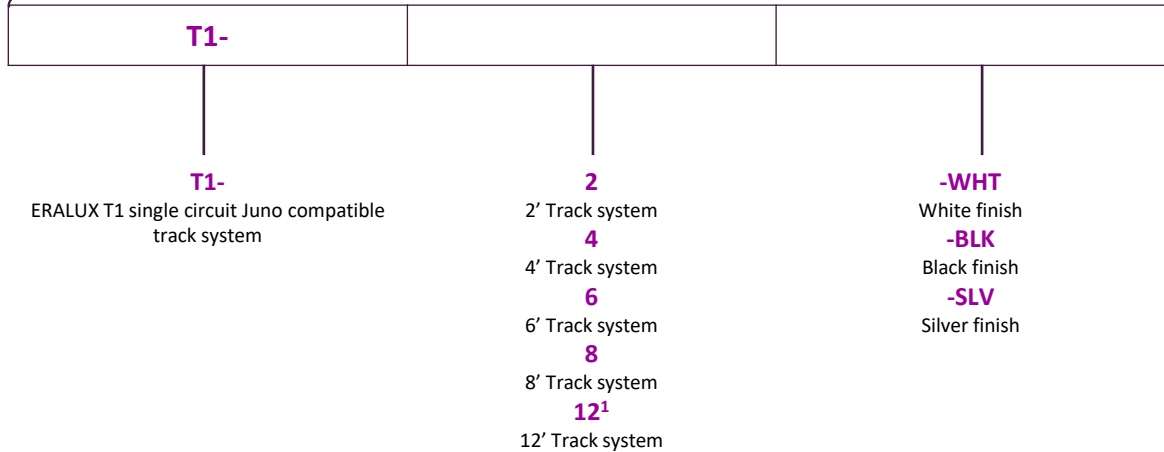







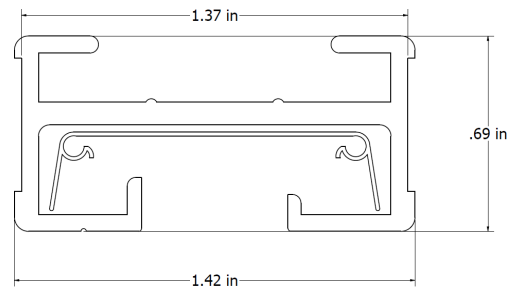

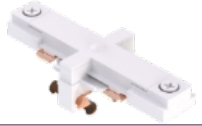

Fixture Family	Length	Finish
----------------	--------	--------

¹For 12 feet tracks, please contact factory for shipping costs

PART NO.	LENGTH	LENGTH
T1-2	2'	512 mm (20.16")
T1-4	4'	1122 mm (44.17")
T1-6	6'	1732 mm (68.19")
T1-8	8'	2341 mm (92.17")
T1-12	12'	3581.4 mm(141")



ACCESSORIES

ORDERING CODE		DESCRIPTION	PICTURE
T10001	-WHT	Mini I Connector	
	-BLK		
	-SLV		
T10002	-WHT	T Connector	
T10002R (Reverse)	-BLK		
	-SLV		
T10003	-WHT	L Connector	
	-BLK		
	-SLV		
T10004	-WHT	X Connector	
	-BLK		
	-SLV		
T10005	-WHT	Floating Canopy	
	-BLK		
	-SLV		
T10006	-WHT	Conduit End Feed	
T10006R (Reverse)	-BLK		
	-SLV		
T10007	-WHT	Flexible Connector	
	-BLK		
	-SLV		
T10008	-WHT	End Feed Kit and Cover	
	-BLK		
	-SLV		
T10009	-WHT	End Cap	
	-BLK		
	-SLV		
T10010	-WHT	Pendant Luminaire Adapter, Chain	
	-BLK		
	-SLV		
T10011	-WHT	Pendant Luminaire Adapter, Cord	
	-BLK		
	-SLV		

ACCESSORIES

ORDERING CODE		DESCRIPTION	PICTURE
T10012	-WHT	T-Bar Connector	
	-BLK		
	-SLV		
T10013	-WHT	T-Bar End Feed	
	-BLK		
	-SLV		
T10014	-WHT	Mounting Accessory for T-Bar Grid Ceilings	
	-BLK		
	-SLV		
T10015	-WHT	Top Access End Feed	
T10015R (Reverse)	-BLK		
	-SLV		
T10016	-WHT	Line Voltage Mono-Point Adapter	
	-BLK		
	-SLV		
T10017	-WHT	Duo-Point Adapters	
	-BLK		
	-SLV		
T10018	-WHT	Line Voltage Sloped Ceiling Adapter	
	-BLK		
	-SLV		
T10020	-WHT	Cover Plate	
	-BLK		
	-SLV		
T10021	-WHT	Single Circuit End Feed	
	-BLK		
	-SLV		
T10023	-WHT	Single Circuit In-Line Feed	
	-BLK		
	-SLV		
T10026	-WHT	Thin Single Circuit End Feed	
	-BLK		
	-SLV		

MINI I CONNECTOR

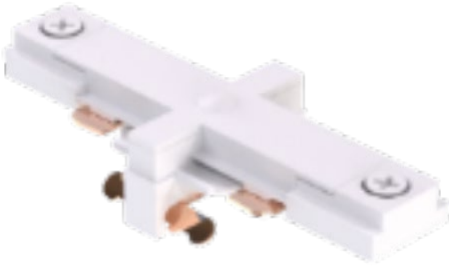

COLOUR	ORDERING CODE
White	T10001-WHT
Black	T10001-BLK
Silver	T10001-SLV

DIMENSIONS (in mm)

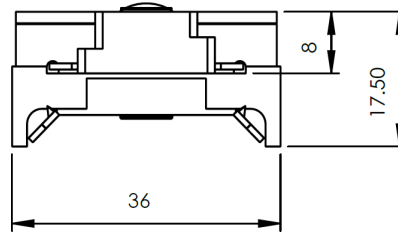
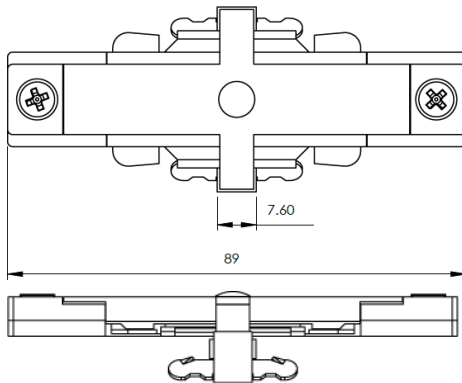

T CONNECTOR



T Connector

COLOUR	ORDERING CODE
White	T10002-WHT
Black	T10002-BLK
Silver	T10002-SLV

DIMENSIONS (in mm)

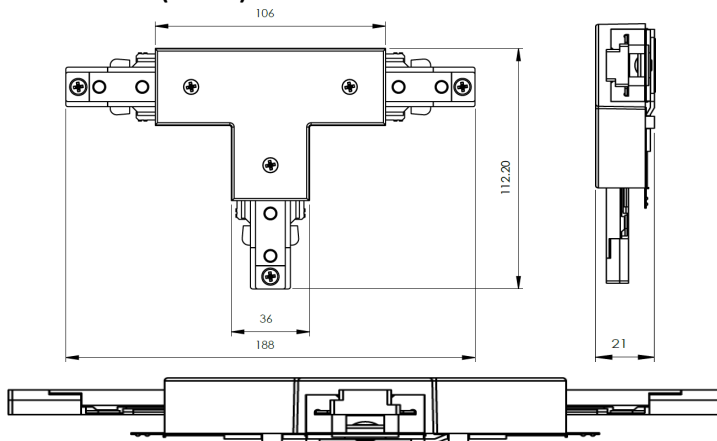

T Connector Reverse

COLOUR	ORDERING CODE
White	T10002R-WHT
Black	T10002R-BLK
Silver	T10002R-SLV

TRACK SYSTEM AND ACCESSORIES

Track Components

L CONNECTOR



DIMENSIONS (in mm)

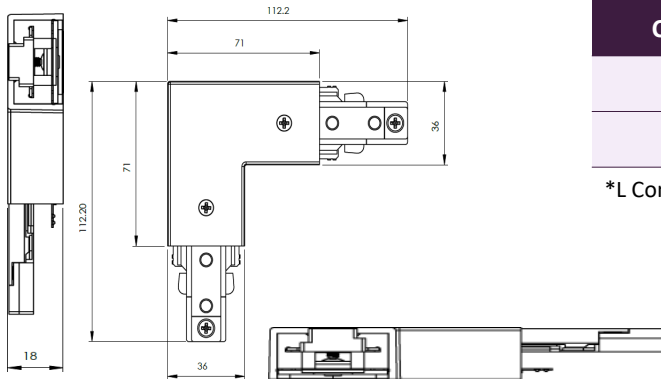

L Connector

COLOUR	ORDERING CODE
White	T10003-WHT
Black	T10003-BLK
Silver	T10003-SLV

L Connector Cover

COLOUR	ORDERING CODE
White	AE-TS-LCONNECTOR-COVER-WH
Black	AE-TS-LCONNECTOR-COVER-BK

*L Connector + Cover → Straight Connector + Power Feed

X CONNECTOR

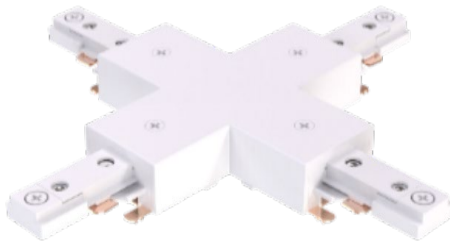

DIMENSIONS (in mm)

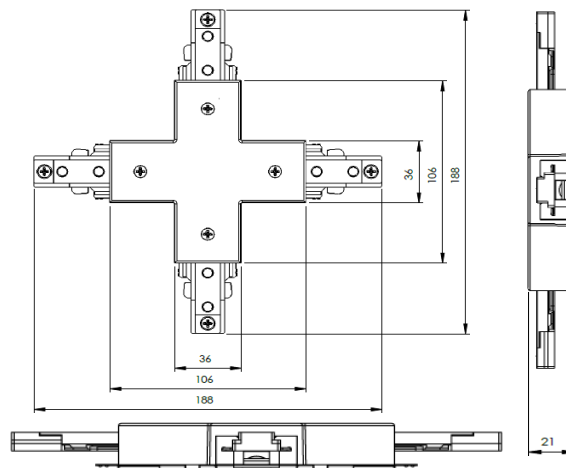

COLOUR	ORDERING CODE
White	T10004-WHT
Black	T10004-BLK
Silver	T10004-SLV

TRACK SYSTEM AND ACCESSORIES

Track Components

FLOATING CANOPY



COLOUR	ORDERING CODE
White	T10005-WHT
Black	T10005-BLK
Silver	T10005-SLV

DIMENSIONS (in mm)

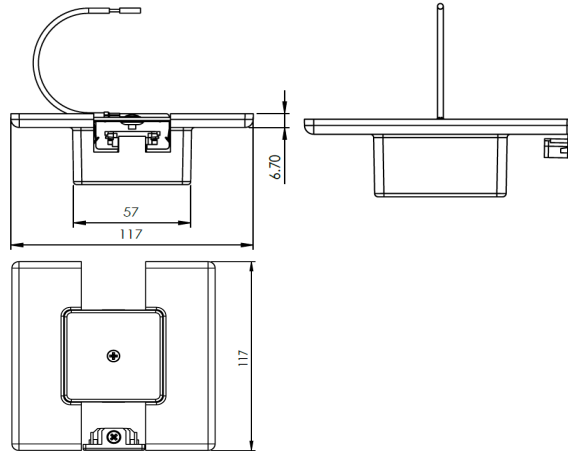

CONDUIT END FEED



Conduit End Feed

COLOUR	ORDERING CODE
White	T10006-WHT
Black	T10006-BLK
Silver	T10006-SLV

DIMENSIONS (in mm)

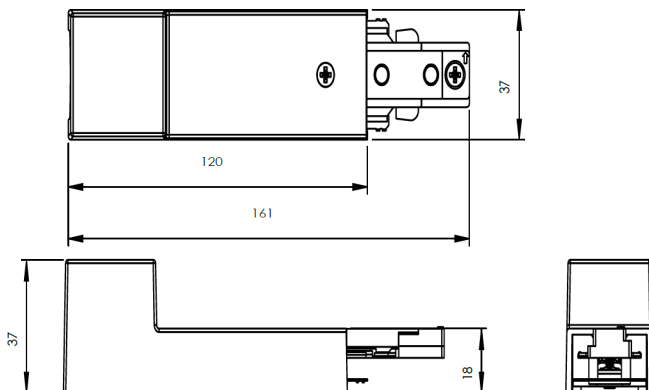

Conduit End Feed Reverse

COLOUR	ORDERING CODE
White	T10006R-WHT
Black	T10006R-BLK
Silver	T10006R-SLV

TRACK SYSTEM AND ACCESSORIES

Track Components

FLEXIBLE CONNECTOR

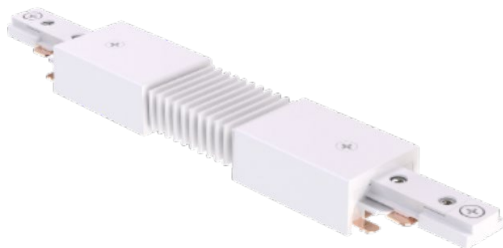

COLOUR	ORDERING CODE
White	T10007-WHT
Black	T10007-BLK
Silver	T10007-SLV

DIMENSIONS (in mm)

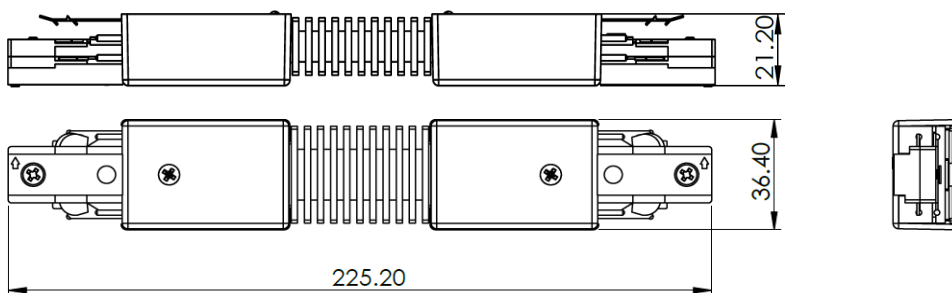

END FEED KIT AND COVER



COLOUR	ORDERING CODE
White	T10008-WHT
Black	T10008-BLK
Silver	T10008-SLV

DIMENSIONS (in mm)

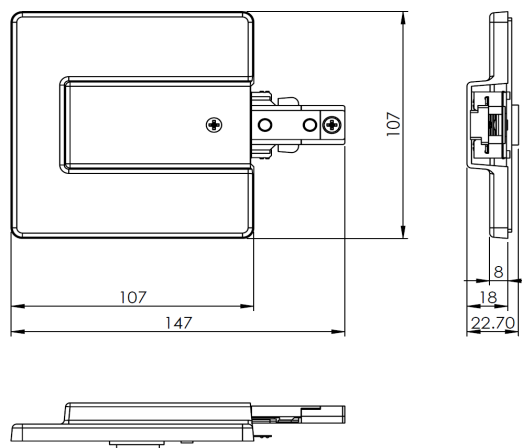

TRACK SYSTEM AND ACCESSORIES

Track Components

T-BAR CONNECTOR



COLOUR	ORDERING CODE
White	T10012-WHT
Black	T10012-BLK
Silver	T10012-SLV

DIMENSIONS (in mm)

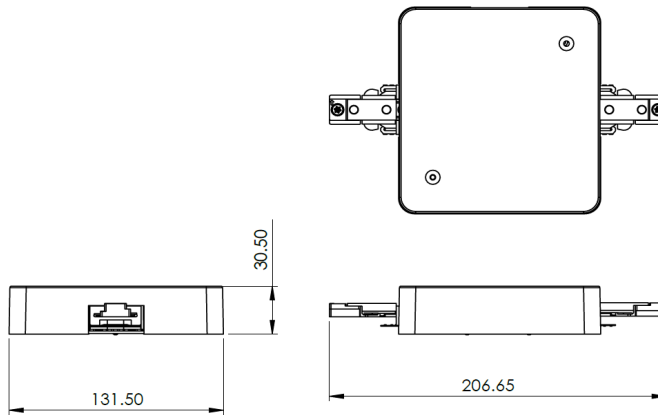

T-BAR END FEED



COLOUR	ORDERING CODE
White	T10013-WHT
Black	T10013-BLK
Silver	T10013-SLV

DIMENSIONS (in mm)

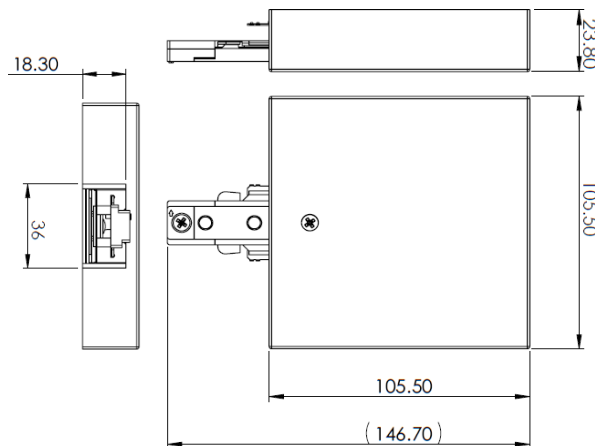

TRACK SYSTEM AND ACCESSORIES

Track Components

TOP ACCESS END FEED



DIMENSIONS (in mm)

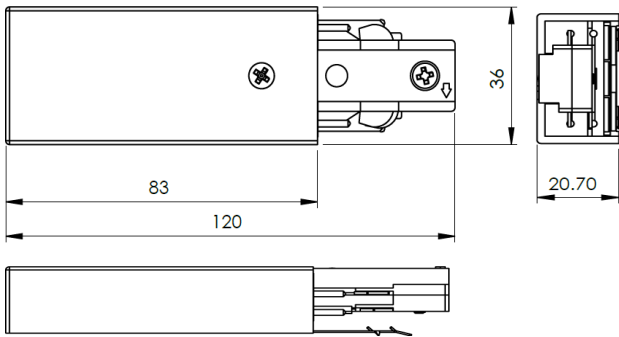

Top Access End Feed

COLOUR	ORDERING CODE
White	T10015-WHT
Black	T10015-BLK
Silver	T10015-SLV

Top Access End Feed Reverse

COLOUR	ORDERING CODE
White	T10015R-WHT
Black	T10015R-BLK
Silver	T10015R-SLV

SINGLE CIRCUIT END FEED



DIMENSIONS (in mm)

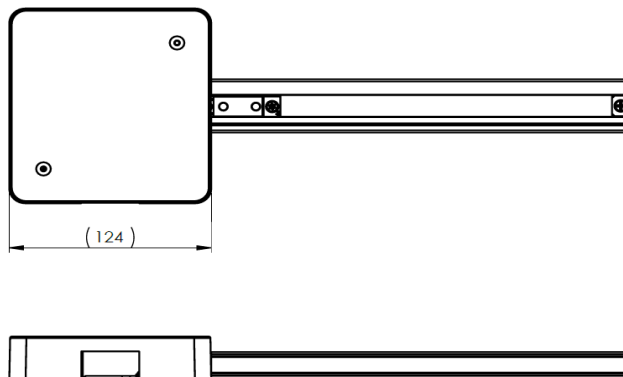

COLOUR	ORDERING CODE
White	T10021-WHT
Black	T10021-BLK
Silver	T10021-SLV

TRACK SYSTEM AND ACCESSORIES

Track Components

SINGLE CIRCUIT IN-LINE FEED



COLOUR	ORDERING CODE
White	T10023-WHT
Black	T10023-BLK
Silver	T10023-SLV

DIMENSIONS (in mm)

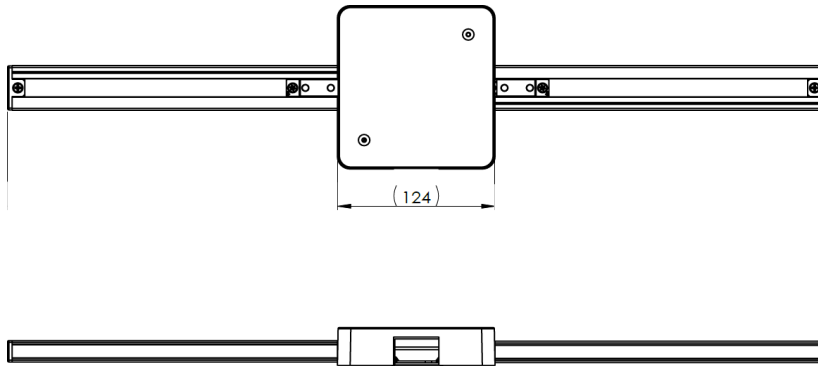
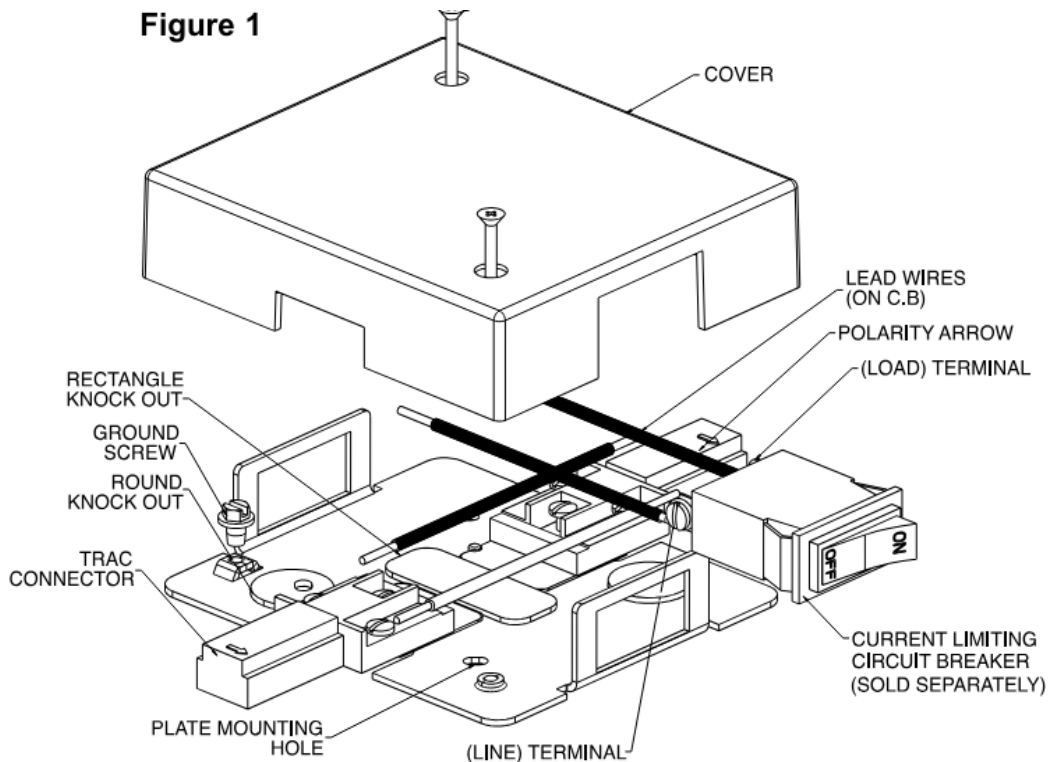

Figure 1



TRACK SYSTEM AND ACCESSORIES

Track Accessories

TRACK COMPONENTS ACCESSORIES



CURRENT LIMITER WHITE	
PART NUMBER	CURRENT LIMIT
TC-T1-0176	1A
TC-T1-0177	2A
TC-T1-0178	3A
TC-T1-0202	5A
TC-T1-0179	6A
TC-T1-0173	10A
TC-T1-0174	14A
TC-T1-0175	15A



CURRENT LIMITER BLACK	
PART NUMBER	CURRENT LIMIT
TC-T1-0203	4A
TC-T1-0204	5A

Current limiters are used to limit the number of track heads that can be installed on a track. It also helps avoiding overcurrent which can damage the fixtures or cause a fire.

The formula to find the current limiter necessary is $I=P/V$, where “I” is the current, “P” is the total power of all the fixtures on the track, and “V” is the input voltage.

Ex: if you have 10 fixtures of 30W, and the input voltage is 120V, your current limit should be at:

$$\frac{10 \times 30W}{120V} = 2.5A$$

STEM KIT FOR SUSPENSION

CANOPY



COLOUR	ORDERING CODE
White	T10027-WHT
Black	T10027-BLK

STEM



COLOUR	LENGTH	ORDERING CODE
White	48"	TS48-WHT
	36"	TS36-WHT
	24"	TS24-WHT
	12"	TS12-WHT
Black	48"	TS48-BLK
	36"	TS36-BLK
	24"	TS24-BLK
	12"	TS12-BLK

*Each product is ordered separately

TRACK SYSTEM AND ACCESSORIES

Track Suspension

SUSPENSION TRACK WIRES

Whether using a cable coupler or a looped cable method, these suspension track wires are designed to suspend track systems from the ceilings. These kits comes in two assemblies of 150 inches cables, grippers and 8-32 bolts.

ORDERING GUIDE

G-16TRK-SR-		-150
G-16TRK-SR- 1/16" galv. cable, gripper, and 8-32 bolt	44 Looped cable CC Cable Coupler	-150 150 inches length suspension wire
Family	Suspension Type	Wire Length

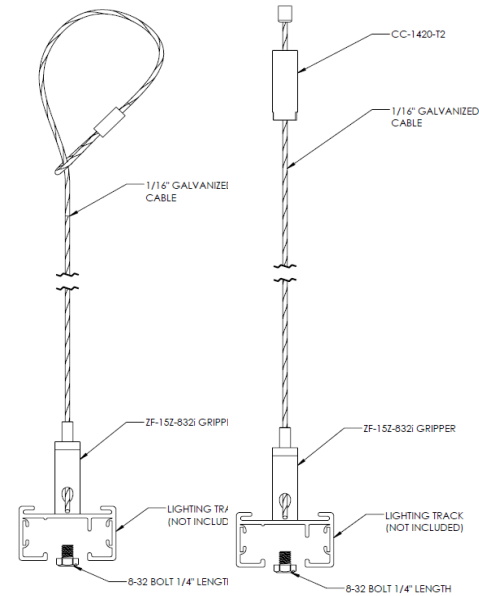

SUSPENSION TRACK BRACKET

This suspension track bracket are designed to suspend track systems from the ceilings.

COMPATIBLE MOUNTING

Mounting	For suspended track systems
Eralux Track Systems	T1 T2

ORDERING GUIDE

AE-TS-SUS-KIT-TRK		
AE-TS-SUS-KIT-TRK Suspension bracket for suspending tracks Two suspension brackets, 20FT galvanized cable, gripper, and one screw	-BLK Black finish bracket -WHT White finish bracket	BLANK Suspension ceiling mount bracket -HOLDER Holder
Fixture Family	Finish	Holder

AE-TS-SUS-KIT-TRK-BLK

AE-TS-SUS-KIT-TRK-BLK-HOLDER



Holder

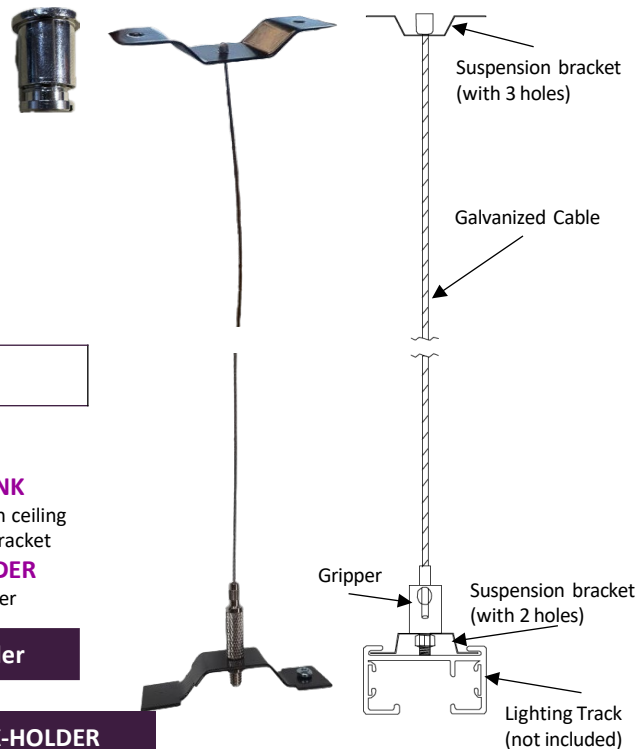

TRACKHEAD EXTENSION WAND



COLOUR	LENGTH	ORDERING CODE
White	12"	T1-Extwand-12"-WHT
	18"	T1-Extwand-18"-WHT
	24"	T1-Extwand-24"-WHT
	36"	T1-Extwand-36"-WHT
	48"	T1-Extwand-48"-WHT
Black	12"	T1-Extwand-12"-BLK
	18"	T1-Extwand-18"-BLK
	24"	T1-Extwand-24"-BLK
	36"	T1-Extwand-36"-BLK
	48"	T1-Extwand-48"-BLK

TRACK SYSTEM AND ACCESSORIES

Recessed Track Housing

TRACK ACCESSORIES AND CONNECTIONS

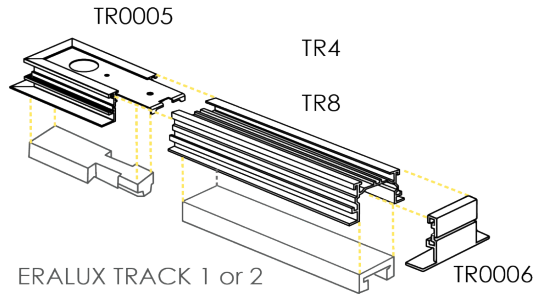

Family	Length	Finish
TR- ERALUX TR reversed circuit Juno compatible track systems	4 4' Track system 8 8' Track system 12 12' Track system	-WHT White finish -BLK Black finish -SLV Silver finish

TRACK COMPONENTS

RECESSED HOUSING FOR I CONNECTOR



COLOUR	ORDERING CODE
White	TR0001-WHT
Black	TR0001-BLK
Silver	TR0001-SLV

RECESSED HOUSING FOR T CONNECTOR

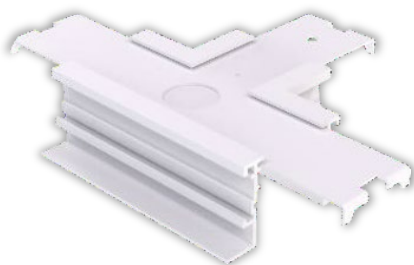

COLOUR	ORDERING CODE
White	TR0002-WHT
Black	TR0002-BLK
Silver	TR0002-SLV

TRACK COMPONENTS

RECESSED HOUSING FOR L CONNECTOR



COLOUR	ORDERING CODE
White	TR0003-WHT
Black	TR0003-BLK
Silver	TR0003-SLV

RECESSED HOUSING FOR END FEED



COLOUR	ORDERING CODE
White	TR0005-WHT
Black	TR0005-BLK
Silver	TR0005-SLV

RECESSED HOUSING FOR END PIECE



COLOUR	ORDERING CODE
White	TR0006-WHT
Black	TR0006-BLK
Silver	TR0006-SLV