

# JUPITER TRACK ST18

## TRACK SYSTEM AND ACCESSORIES

The JUPITER ST18 track is a recessed snap-in track system. This 2" low-voltage track is compatible with the JUPITER track head series, comprised of a variety of cylindrical, pendant and linear track lights. The modules are easily mounted using snap-in adapters. The track and power distribution are suitable for retail, commercial, and residential use.

	DATE	QTY	ACC. QTY	TYPE
PROJECT				
PN				
ACCESSORY PN				
NOTES				

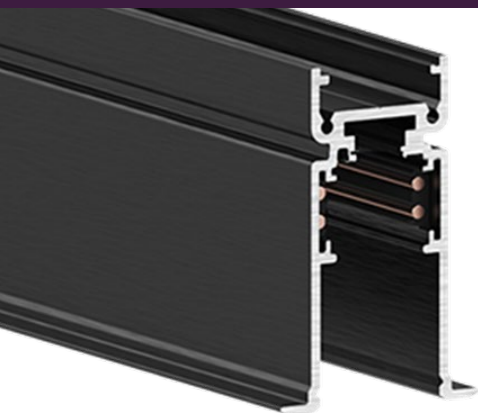

### PRODUCT CERTIFICATIONS



### SYSTEM WARRANTY – 3 YEARS

Eralux will warrant defective drivers, LEDs and boards for 3 years from the date of purchase. This warranty is valid only if the fixture is installed and used as per installation guides and specifications. If a defect is present, Eralux will send drivers and boards at no fee with a thorough replacement instructions along with instructions on the return of the defective parts back to Eralux.

### ORDERING GUIDE

<b>9500</b>			<b>-ST18-E</b>
-------------	--	--	----------------

**9500**  
ERALUX Jupiter  
Snap-In Track

**-UL4**  
4ft track  
**-UL8**  
8ft track

**/B**  
Black Finish  
**/W2**  
White Finish

**-ST18-E**  
2-Inch Depth

Track System	Length	Finish	Depth
--------------	--------	--------	-------

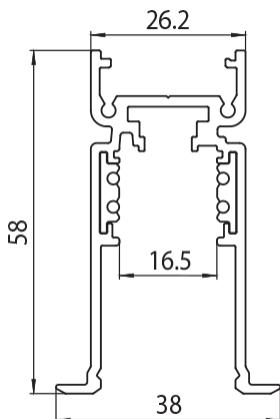

PART NO.	LENGTH
9500-UL4	4ft (1219.2 mm)
9500-UL8	8ft (2438.4 mm)

### ACCESSORIES

ORDERING CODE		DESCRIPTION	PICTURE
JP10001	-WHT	I Connector	
	-BLK		
JR20003	-WHT	L Connector	
	-BLK		
JP10015   JP10015R (Reverse)	-WHT	End Feed	
	-BLK		
JR20009	-WHT	End Cap	
	-BLK		
JR20009H	-WHT	End Cap with Hole	
	-BLK		
JP20027	-WHT	8ft Aesthetic Track Cover	
	-BLK		

#### NOTES

- All connectors come with housing. See pages 4-5 for more details.
- See page 5 for an example track configuration.

### CLAMP FOR RECESSED MOUNTING

ORDERING CODE
S-9500/112

Silver finish only.



### SUSPENSION KIT

ORDERING CODE
9500-KIT1-5

Silver finish only.

Includes:

- Round head ceiling attachment
- Steel cable (0.059in diameter and 196.85in length) with spherical end
- Bracket with automatic gripper



#### NOTES

- 2 clamps/mounting kits for 4ft of track.
- 3 clamps/mounting kits for 8ft of track.
- See install instructions for more information.

### EXTERNAL DRIVER

ORDERING CODE
ELG-75-48AB

- 48V output low-voltage driver
- Necessary for Jupiter snap-in track heads

SPECIFICATIONS	
Input Voltage	100-240/277V
Output Voltage	43.2-52.8V
Output Power	60W max
Dimming	0-10V
Current	1.6A
Ambient Temperature	-40°C to 60°C
	-40°F to 140°F
IP Rating	IP65

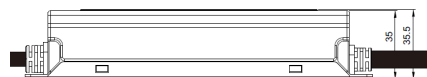
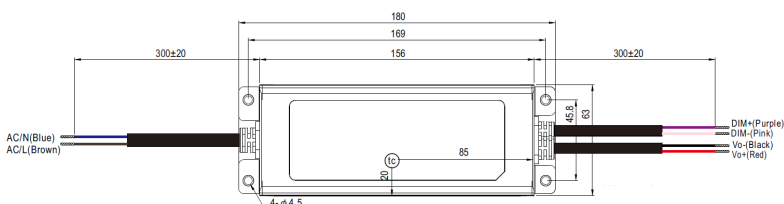

# JUPITER TRACK ST18

## TRACK SYSTEM AND ACCESSORIES

Snap-In Track | 2" Recessed

### END FEED



#### DIMENSIONS (in mm)

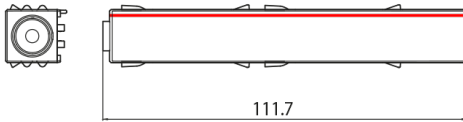

POLARIZATION	ORDERING CODE	BOM
Standard (Right)	JP10015-WHT	9501-S-KR/W-E
	JP10015-BLK	9501-S-KR/B-E
Reverse (Left)	JP10015R-WHT	9501-S-KL/W-E
	JP10015R-BLK	9501-S-KL/B-E

### I CONNECTOR



#### DIMENSIONS (in mm)

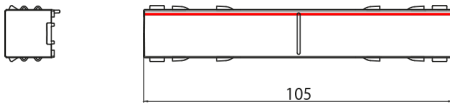

ORDERING CODE	BOM
JP10001-WHT	9503-S-K/W-E S-9500/423-LA
JP10001-BLK	9503-S-K/B-E S-9500/423-LA

### L CONNECTOR

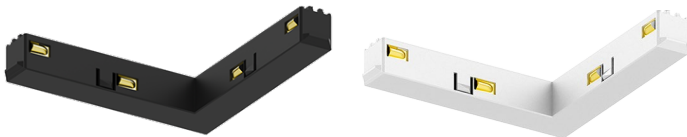

#### DIMENSIONS (in mm)

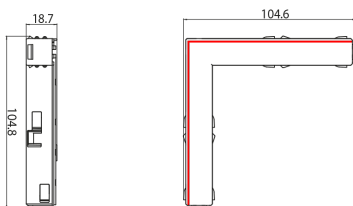

ORDERING CODE	BOM
JR20003-WHT	9511-KE/W-E S-9511/W2-ST18-E
JR20003-BLK	9511-KE/B-E S-9511/B-ST18-E

## TRACK SYSTEM AND ACCESSORIES

Snap-In Track | 2" Recessed

### END CAPS AND TRACK COVER



JR20009



JR20009H



JP20027

ORDERING CODE	BOM
JR20009-WHT	9504/ST18-W2
JR20009-BLK	9504/ST18-B
JR20009H-WHT	9504/ST18-W2-F
JR20009H-BLK	9504/ST18-B-F
JP20027-WHT	S-9500-LE/W2-UL8
JP20027-BLK	S-9500-LE/B-UL8

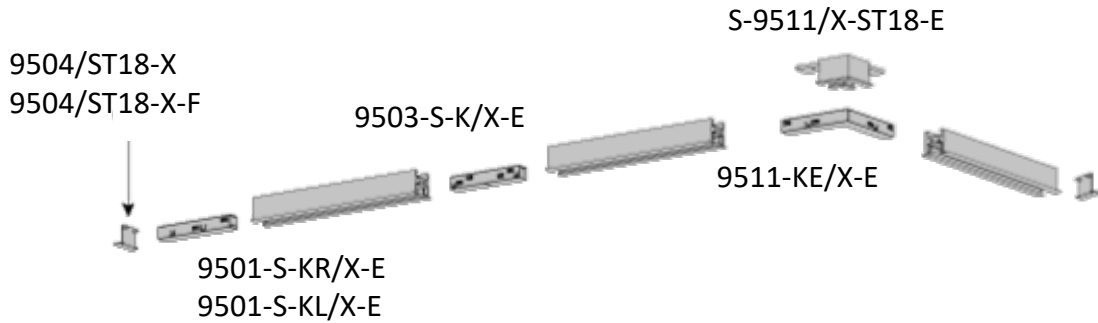

### JUPITER TRACK – ALL MODELS

MODEL	DEPTH	MOUNTING	PICTURE
<u>ST6</u>	1"	Surface or Suspended	
<u>ST2</u>	2"		
<u>ST8</u>	1"	Recessed	
<u>ST18</u>	2"		