

JUPITER TRACK ST6

SNAP-IN TRACK SYSTEM AND ACCESSORIES

The JUPITER ST6 track is a two-circuit snap-in track system that can be surface mounted or suspended. This 1" low-voltage track is compatible with the JUPITER track head series, comprised of a variety of cylindrical, pendant and linear track lights. The modules are easily mounted using snap-in adapters. The track and power distribution are suitable for retail, commercial, and residential use.

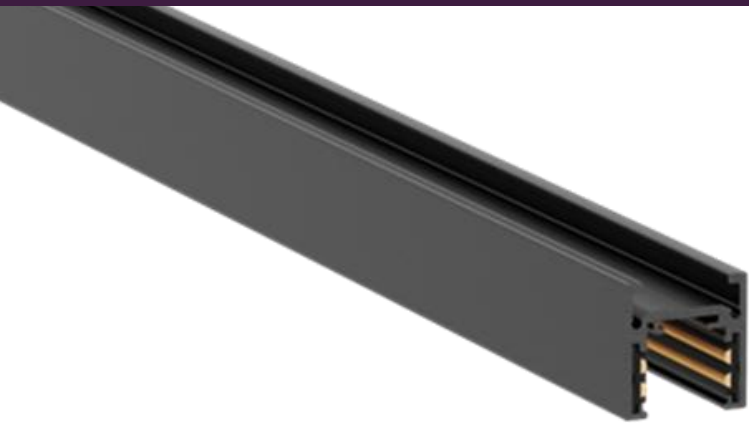

| | DATE | QTY | ACC. QTY | TYPE |
|--------------|------|-----|----------|------|
| PROJECT | | | | |
| PN | | | | |
| ACCESSORY PN | | | | |
| NOTES | | | | |

PRODUCT CERTIFICATIONS



SYSTEM WARRANTY – 3 YEARS

Eralux will warrant defective drivers, LEDs and boards for 3 years from the date of purchase. This warranty is valid only if the fixture is installed and used as per installation guides and specifications. If a defect is present, Eralux will send drivers and boards at no fee with a thorough replacement instructions along with instructions on the return of the defective parts back to Eralux.

ORDERING GUIDE

| | | | |
|-------------|--|--|---------------|
| 9500 | | | -ST6-E |
|-------------|--|--|---------------|

9500
ERALUX Jupiter
Snap-In Track

-UL4
4ft track
-UL8
8ft track

/B
Black Finish
/W2
White Finish

-ST6-E
1-Inch Depth

| Track System | Length | Finish | Depth |
|--------------|--------|--------|-------|
|--------------|--------|--------|-------|

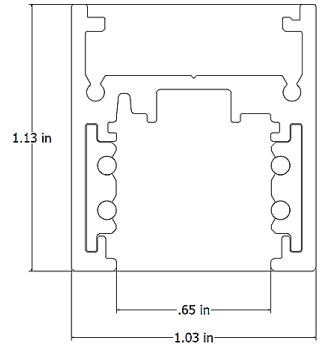

| PART NO. | LENGTH |
|----------|----------------|
| 9500-UL4 | 4ft (1219.2mm) |
| 9500-UL8 | 8ft (2438.4mm) |

TRACK SYSTEM AND ACCESSORIES

Snap-In Track | 1" Surface Mounted or Suspended

ACCESSORIES

| ORDERING CODE | | DESCRIPTION | PICTURE |
|------------------------------|------|---------------------------|---------|
| JP10001 | -WHT | I Connector | |
| | -BLK | | |
| JS20002 JS20002R (Reverse) | -WHT | T Connector | |
| | -BLK | | |
| JS20003 | -WHT | L Connector | |
| | -BLK | | |
| JS20004 | -WHT | X Connector | |
| | -BLK | | |
| JP10015 JP10015R (Reverse) | -WHT | End Feed | |
| | -BLK | | |
| JS20009 | -WHT | End Cap | |
| | -BLK | | |
| JS20009H | -WHT | End Cap with Hole | |
| | -BLK | | |
| JP20027 | -WHT | 8ft Aesthetic Track Cover | |
| | -BLK | | |

NOTES

- All connectors come with housing. See pages 4-5 for more details.
- See page 6 for an example track configuration.

TRACK SYSTEM AND ACCESSORIES

Snap-In Track | 1" Surface Mounted or Suspended

CLAMP FOR CEILING MOUNT

| ORDERING CODE | |
|---------------|-----|
| S-9500/114 | -B |
| | -W2 |

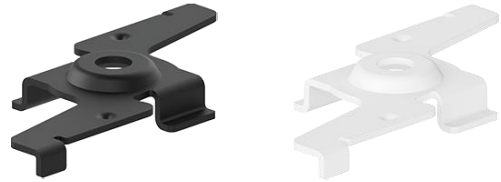

- Black or white finish
- Painted steel clamp

SUSPENSION KIT

| ORDERING CODE |
|---------------|
| 9500-KIT1-5 |

- Silver finish only
- Round head ceiling attachment
- Steel cable (0.059in diameter and 196.85in length) with spherical end
- Bracket with automatic gripper



NOTES

- 2 clamps/suspension kits for 4ft of track.
- 3 clamps/suspension kits for 8ft of track.
- See install instructions for more information.

EXTERNAL DRIVER

| ORDERING CODE |
|---------------|
| ELG-75-48AB |

- 48V output low-voltage driver
- Necessary for Jupiter snap-in track heads

| SPECIFICATIONS | |
|---------------------|----------------|
| Input Voltage | 100-240/277V |
| Output Voltage | 43.2-52.8V |
| Output Power | 60W max |
| Dimming | 0-10V |
| Current | 1.6A |
| Ambient Temperature | -40°C to 60°C |
| | -40°F to 140°F |
| IP Rating | IP65 |

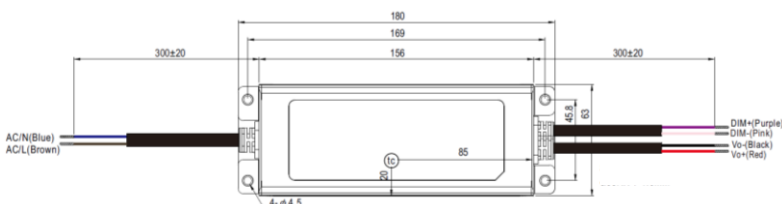

JUPITER TRACK ST6

TRACK SYSTEM AND ACCESSORIES

Snap-In Track | 1" Surface Mounted or Suspended

END FEED



DIMENSIONS (in mm)

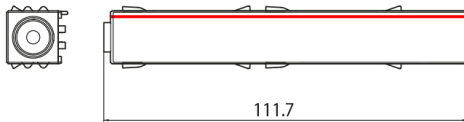

| POLARIZATION | ORDERING CODE | BOM |
|------------------|---------------|---------------|
| Standard (Right) | JP10015-WHT | 9501-S-KR/W-E |
| | JP10015-BLK | 9501-S-KR/B-E |
| Reverse (Left) | JP10015R-WHT | 9501-S-KL/W-E |
| | JP10015R-BLK | 9501-S-KL/B-E |

I CONNECTOR



DIMENSIONS (in mm)



| ORDERING CODE | BOM |
|---------------|-------------------------------|
| JP10001-WHT | 9503-S-K/W-E S-9500/423-LA |
| JP10001-BLK | 9503-S-K/B-E S-9500/423-LA |

| ORDERING CODE | DESCRIPTION | PICTURE |
|---------------|------------------------------------|---------|
| S-9500/423-LA | Mechanical Link for Continuous Row | |

L CONNECTOR

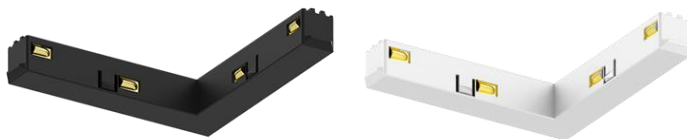

DIMENSIONS (in mm)

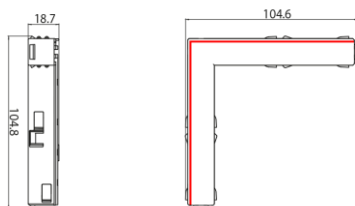

| ORDERING CODE | BOM |
|---------------|--------------------------------|
| JS10003-WHT | 9511-KE/W-E S-9511/W2-P-ST6 |
| JS10003-BLK | 9511-KE/B-E S-9511/B-P-ST6 |

TRACK SYSTEM AND ACCESSORIES

Snap-In Track | 1" Surface Mounted or Suspended

T CONNECTOR



DIMENSIONS (mm)

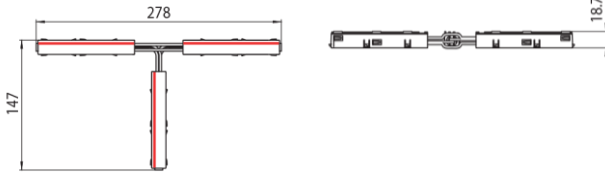

| POLARIZATION | ORDERING CODE | BOM |
|------------------|---------------|-------------------------------|
| Standard (Right) | JS10002-WHT | 9514-K/W-E S-9513/W2-P-ST6 |
| | JS10002-BLK | 9514-K/B-E S-9513/B-P-ST6 |
| Reverse (Left) | JS10002R-WHT | 9513-K/W-E S-9513/W2-P-ST6 |
| | JS10002R-BLK | 9513-K/B-E S-9513/B-P-ST6 |

X CONNECTOR



DIMENSIONS (mm)

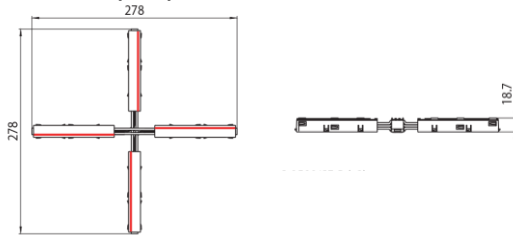

| ORDERING CODE | BOM |
|---------------|-------------------------------|
| JS10004-WHT | 9517-K/W-E S-9517/W2-P-ST6 |
| JS10004-BLK | 9517-K/B-E S-9517/B-P-ST6 |

END CAPS AND TRACK COVER



JS10009



JS10009H

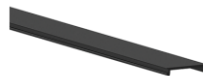

JP10027

| ORDERING CODE | BOM |
|---------------|------------------|
| JS10009-WHT | 9504/ST6-P-W2 |
| JS10009-BLK | 9504/ST6-P-B |
| JS10009H-WHT | 9504/ST6-P-W2-F |
| JS10009H-BLK | 9504/ST6-P-B-F |
| JP10027-WHT | S-9500-SE/W2-UL8 |
| JP10027-BLK | S-9500-SE/B-UL8 |

TRACK SYSTEM AND ACCESSORIES

Snap-In Track | 1" Surface Mounted or Suspended

TRACK CONFIGURATION

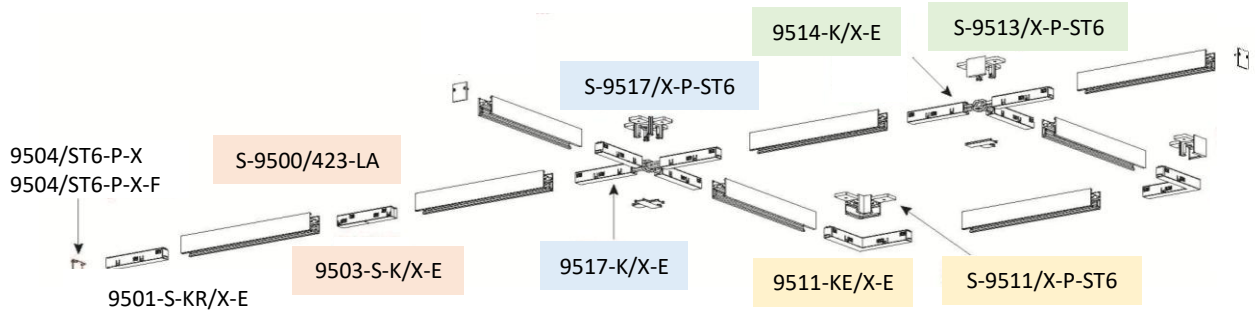

JUPITER TRACK – ALL MODELS

| MODEL | DEPTH | MOUNTING | PICTURE |
|-------------|-------|----------------------|---------|
| <u>ST6</u> | 1" | Surface or Suspended | |
| <u>ST2</u> | 2" | | |
| <u>ST8</u> | 1" | Recessed | |
| <u>ST18</u> | 2" | | |