

# OVA

## LED COMMERCIAL DOWNLIGHT

### Surface Mount Disk | 4" Round

The OVA Series is round semi oval shape surface mounted downlight disk. Its selectable CCT switch lets you adjust the color temperature from 2700K to 5000K. Available in 4" aperture size with 10W respectively and an output of 82lm/W, providing a versatile lighting option for any space, in addition to the surface mount it can be retrofit installed into can with the suitable accessories.

Applications: Office | Retail stores | Hotels | Restaurants | Home interior | Library Etc.

eralux®

	DATE	QTY	ACC. QTY	TYPE
PROJECT				
PN				
ACCESSORY PN				
NOTES				



### DYNAMIC MENU

Order Information	<a href="#">Page 2</a>
Dimensions	<a href="#">Page 3</a>
Accessories	<a href="#">Page 4</a>
Photometric Data	<a href="#">Page 6</a>

[Install Instruction link](#)

### SPECIFICATIONS

Input Voltage	120V
Power Factor	>0.9
Total Harmonic Distortion	<20%
Dimming <a href="#">Page 6</a>	TRIAC
CRI	90 CRI
CCT	<div style="display: flex; gap: 10px;"> <span style="border: 1px solid black; border-radius: 50%; padding: 2px 5px;">27K</span> <span style="border: 1px solid black; border-radius: 50%; padding: 2px 5px;">30K</span> <span style="border: 1px solid black; border-radius: 50%; padding: 2px 5px;">35K</span> <span style="border: 1px solid black; border-radius: 50%; padding: 2px 5px;">40K</span> <span style="border: 1px solid black; border-radius: 50%; padding: 2px 5px;">50K</span> </div>
Efficacy	~ 82 LPW
Size	4"
Power	10W
Ambient Temperature Range	-20°C to 40°C
Mounting	Surface mount Recessed retrofit into can
Finish	White
Material	Iron housing

Distribution



### PRODUCT FEATURES



### PRODUCT CERTIFICATIONS



### SYSTEM WARRANTY – 5 YEARS

Eralux will warrant defective drivers, LEDs and boards for 5 years from the date of purchase. This warranty is valid only if the fixture is installed and used as per installation guides and specifications. If a defect is present, Eralux will send drivers and boards at no fee with a thorough replacement instructions along with instructions on the return of the defective parts back to Eralux.

### LUMEN MAINTENANCE – L70 at 50,000 hours

Rated for 70% initial lumen output at 50,000 hours of operation, operated at 25°C ambient temperature; per guidelines published by the Illuminating Engineering Society (IES).

## LED COMMERCIAL DOWNLIGHT

Surface Mount Disk | 4" Round



### ORDERING GUIDE

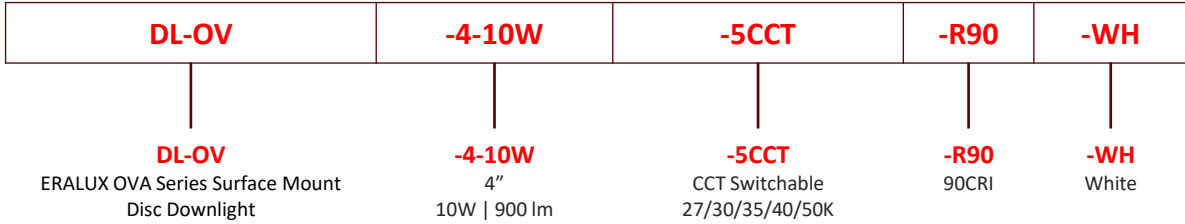

### ORDERING GUIDE - ACCESSORIES

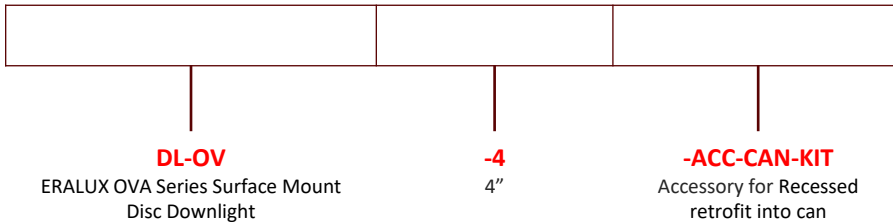

Model Number	Input Voltage	Power	Beam Angle	CCT	Lumens
<b>AE-DL-OV-4-10W-5CCT-R90-WH</b>	120V	10W	110	2700K	820lm
				3000K	830lm
				3500K	900lm
				4000K	850lm
				5000K	830lm

### DIMENSIONS

FIXTURE

Drill position

AE-DL-OV-4-10W

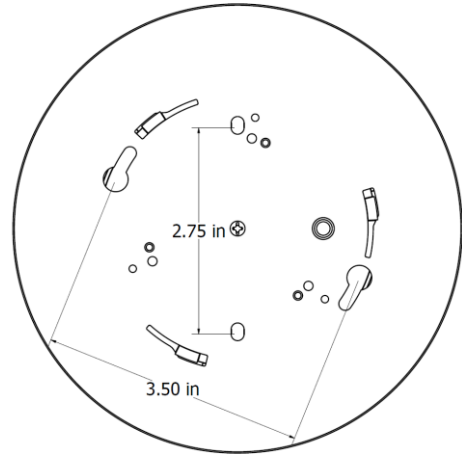
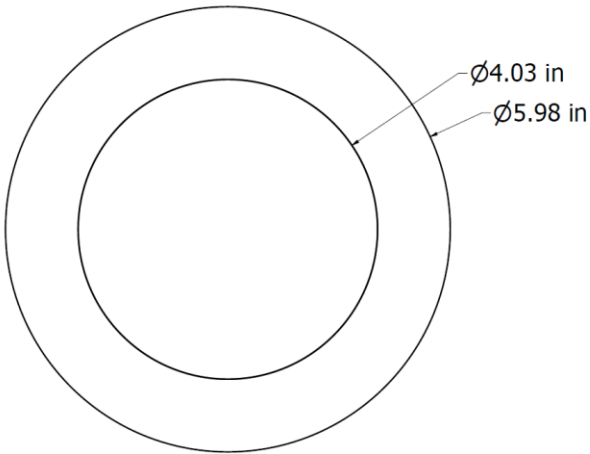
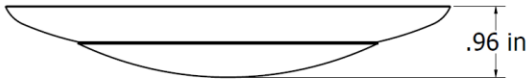

### ACCESSORIES

Accessory for Recessed retrofit into can

Installation Sketch

AE-DL-OV-4-ACC-CAN-KIT



**3 Mounting Bracket  
E26 Base Whip**

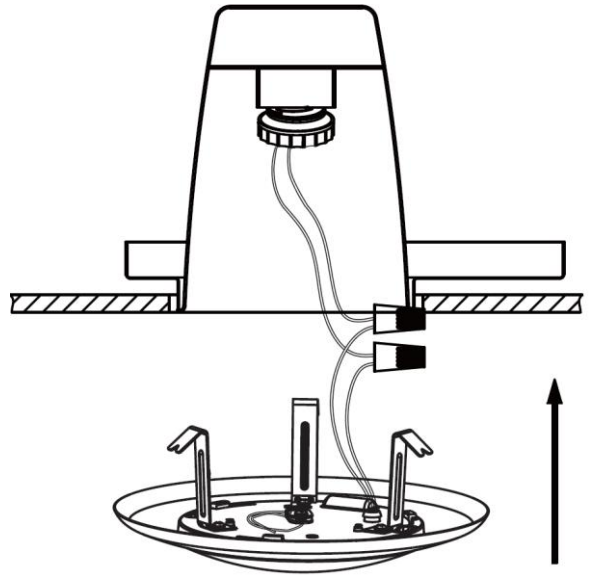

## LED COMMERCIAL DOWNLIGHT

Surface Mount Disk | 4" Round

### CONTROLS

Ordered separately, field installed

#### EMERGENCY LED DRIVER (BLD-HMXXD-YYY)

BLD-HM8D-YYY



The BLD-HMXXD-YYY series LED Emergency Driver is UL listed for field and factory installations. It switches to emergency mode during power failures, providing up to 90 minutes of lighting. With an integrated battery, charger, and converter, it delivers 6-25W constant power at 170VDC. Ideal for 0-10V dimmable indoor commercial LED fixtures, such as flat panels, troffers, downlights, and linear strip lights.

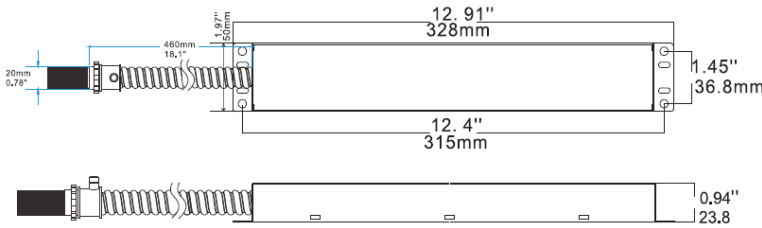

### ROOM OCCUPANCY SENSOR

PART NUMBER	DESCRIPTION
AE-CT-DT806	Line Voltage Motion Sensor
RC102	RC102 Remote Control



SPECIFICATIONS	
Input Voltage	100-347 Vac
Power Frequency	50/60HZ
Input Power	8W max
Output Voltage	170V Dc
Output Power	8W
Ambient Temperature	0°C to 50°C
	30°F to 122°F
Installation	Remote

SPECIFICATIONS		
Input Voltage	120-277 Vac	
Power Frequency	50/60HZ	
Rated Load	At 120 Vac	800W
	At 277 Vac	1200W
Detection Range	3-10 Meters	
	9.8-32.8 Feet	
Standby Power	~0.9W	
Time Setting	10 sec to 30 min	
Light Control	10-2,000LUX	
Installation	Ceiling Mounted	

### DIMMER COMPATIBILITY LIST

TRIAC Dimming

Brand	Model	Brand	Model
LUTRON	SCL-153P	LUTRON	CL-6683
	CTCL-153P		IPLO6
	DVCL-153P		CL-6672
	MACL-153M		MACL-153M
	MACL-153MR-WH		EDV-600P
	CL-6674		153M-ES
	TG-600PH-LA		

### LUMENS ESTIMATE

Lumen output varies based on CCT and CRI. An estimate of lumen output of the various CCT/CRI combinations, use correction factors as per table below:

LUMEN ESTIMATE ADJUSTMENT FACTORS				
CCT	2700K	3000K	3500K	4000K
NORMAL	0.97	1	1.03	1.05

### PHOTOMETRIC DATA

PART NUMBER		ZONAL LUMEN SUMMARY			POLAR LUMINOUS INTENSITY
AE-DL-OV-4-10W-5CCT-R90-WH		Zone	Lumens	% Fixture	
Wattage	10W	0-20°	67.25	11.8	
CCT	3500K	0-30°	143.7	25.2	
Distribution	110°	0-40°	236.76	41.5	
		0-60°	427.51	74.9	
		0-80°	552.27	96.8	
		0-90°	570.79	100	

### OVERVIEW



#### Innovative Design

- Iron housing for better heat dissipation.



#### Multiple Options

5 CCT switchable from 2700K to 5000K.



#### Mountings Available

- Surface mount to a junction box size: 2.75" or 3.5" for 4" OVA
- Recessed retrofit using additional accessories.



#### Tests And Certifications



Emergency backup battery

