

SB2

eralux®

INDUSTRIAL LED LIGHT

High Bay UFO | 150-240-300W

The SB2 series is a round high bay with power and CCT switchable. This series features 3 power packages; 100/125/150W, 150/200/240W, and 200/240/300W with 150 LPW performance. It comes with various accessories form reflector, reflector cover, wire guard to plug in motion sensor and EMBB. The SB2 has rating of NEMA 4X which is equivalent to IP66. In addition to natatorium option which means that the fixture can be placed in wet environment.

Application: Industrial, Manufacturing, Warehouse, High-bay applications, Pools.

	DATE	QTY	ACC. QTY	TYPE
PROJECT				
PN				
ACCESSORY PN				
NOTES				



DYNAMIC MENU

Order Information	Page 2
Dimensions	Page 3
Accessories	Page 4
Photometric Data	Page 7

[Install Instruction link](#)

SPECIFICATIONS

Input Voltage	120-277/347V
Power Factor	>0.9
Total Harmonic Distortion	<20%
Dimming	0-10V Dimming
CRI	80 CRI
CCT	<div style="display: flex; gap: 10px;"> <div style="border: 1px solid gray; border-radius: 50%; padding: 2px 5px;">35K</div> <div style="border: 1px solid gray; border-radius: 50%; padding: 2px 5px;">40K</div> <div style="border: 1px solid gray; border-radius: 50%; padding: 2px 5px;">50K</div> </div>
Lumens Per Watt	~150 LPW
Power	100/125/150W 150/200/240W 300/240/200W
Ambient Temperature Range	-40 °C to 45 °C
Fixture Finish	Black White
Distribution	110°
Mounting Options	Hook Pendant – ¾" NPT conduit
Options	Natatorium
Protection	NEMA 4x equivalent to IP66 Wet Rated 6KV Surge Protector



PRODUCT FEATURES

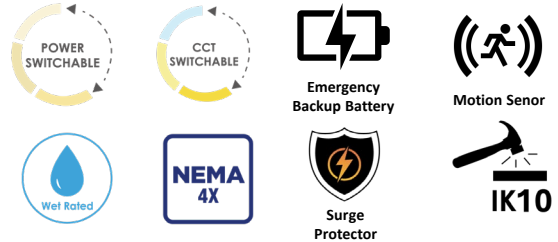

PRODUCT CERTIFICATIONS



“Design Lights Consortium® (DLC) qualified product. Not all versions of this product may be DLC qualified. Please check the DLC Qualified Products List at www.designlights.org/QPL to confirm which versions are qualified” [Page 5](#)

SYSTEM WARRANTY – 5 YEARS

Eralux will warrant defective drivers, LEDs and boards for 5 years from the date of purchase. This warranty is valid only if the fixture is installed and used as per installation guides and specifications. If a defect is present, Eralux will send drivers and boards at no fee with a thorough replacement instructions along with instructions on the return of the defective parts back to Eralux.

LUMEN MAINTENANCE – L70 at 50,000 hours

Rated for 70% initial lumen output at 50,000 hours of operation, operated at 25°C ambient temperature; per guidelines published by the Illuminating Engineering Society (IES).

INDUSTRIAL LED LIGHT

High Bay UFO | 150-240-300W

ORDERING GUIDE

AE-IL-SB2-CA		-110	-H				
AE-IL-SB2-CA ERALUX SB2 High Bay UFO	-150W 150/125/100W 22,500/18,750/15000Lm -240W 240/200/150W 36,000/30,000/22,500Lm -300W 300/240/200W 45,000/36,000/30,000Lm	-110 110 beam angle	-H High output 3500K/4000K/ 5000K CCT Switchable	[BLANK] Black -WH White	[BLANK] Hook Mount -PM¹ Pendant Mount- ¾" NPT Conduit	[BLANK] Standard -NAT² Natatorium Frosted lens and stainless- steel hardware	[BLANK] 0-10V Dimming -MS Motion Sensor
Fixture Family	Power	Distribution	Performance	Finish	Mounting	Specialty	Control

ORDERING GUIDE - ACCESSORIES

AE-IL-SB2-CA ERALUX SB2 High Bay UFO	-WIREGUARD-BK Wire guard Black Finish -WIREGUARD-SS Wire guard Stainless Steel -RFL-PC Polycarbonate reflector -RFL-AL Aluminum reflector	-150W For 150W -240W For 240W -300W For 300W	AE-IL-SB2-CA ERALUX SB2 High Bay UFO	-RFL-PC-COVER³ Polycarbonate reflector cover	-150/300W For 150W and 300W -240W For 240W
Accessory Family	Accessory	Size	Accessory Family	Accessory	Size

[BLANK] No EMBB BLD-UM60D-YYY⁴ 60W Emergency Battery Backup	[BLANK] No Chain AE-IL-SB2-CA-METAL CHAIN 3.2ft Metal chain
EMBB	CHAIN

1. Only adaptor provided by Eralux
2. Lumen output for NAT fixtures will be 20% less than standard fixtures
3. Polycarbonate reflector usually ordered with the polycarbonate reflector
4. The EMBB does not come with remote, the remote is ordered separately if required

INDUSTRIAL LED LIGHT

High Bay UFO | 150-240-300W

DIMENSIONS

FIXTURE

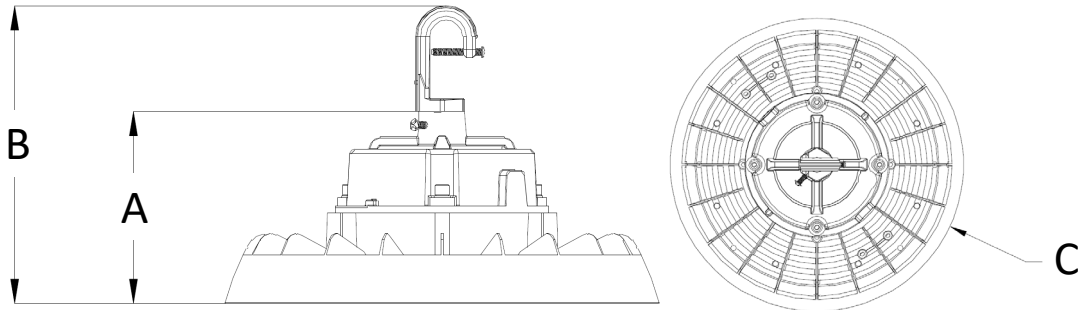

POWER	150W	240W	300W
A	4.43"	4.65"	4.76"
B	7.0"	7.2"	10.42"
C	10.43"	12.82"	13.8"

ACCESSORIES

POWER	150W	240W	300W
WIRE GUARD			
A	9.91"	12.61"	14.35"
B	9.91"	12.61"	14.35"
C	1.18"	1.18"	1.18"

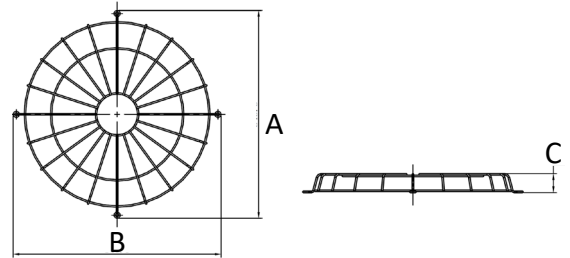

POLYCARBONATE REFLECTOR			
A	16.28"	18.89"	16.22"
B	6.84"	7.12"	4.84"

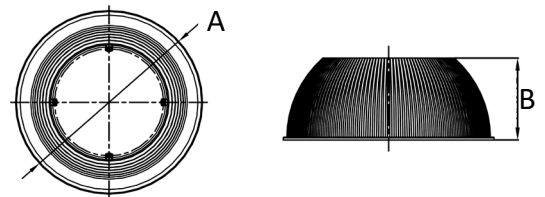

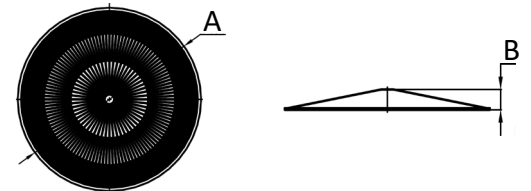

POLYCARBONATE REFLECTOR COVER			
A	15.9"	18.7"	15.9"
B	1.57"	1.57"	1.57"



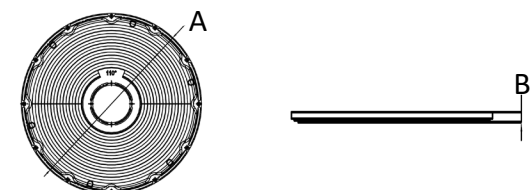



POLYCARBONATE LENS			
A	8.66"	10.66"	11.53"
B	0.28"	0.3"	0.3"

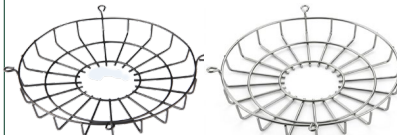

MOUNTING

	DESCRIPTION	PICTURE
HOOK MOUNT	Standard mounting option	
PENDANT	Hook can be replaced by 3/4" NPT conduit mounting.	
METAL CHAIN	Facilitates the installation of the fixture	

ACCESSORIES

CODE	DESCRIPTION	PICTURE
AE-IL-SB2-CA-WIREGUARD-BK-XXXW AE-IL-SB2-CA-WIREGUARD-SS-XXXW	Wire guards help shield the light from accidental impacts. Available in black and stainless steel.	
AE-IL-SB2-CA-RFL-PC-150W AE-IL-SB2-CA-RFL-PC-240W AE-IL-SB2-CA-RFL-PC-300W	Polycarbonate reflectors help in directing and distributing light more evenly across a space.	
AE-IL-SB2-CA-RFL-PC-COVER-150/300W AE-IL-SB2-CA-RFL-PC-COVER-240W	These covers can help diffuse light evenly, reducing glare and creating a more comfortable lighting environment.	
AE-IL-SB2-CA-RFL-AL-150W AE-IL-SB2-CA-RFL-AL-240W AE-IL-SB2-CA-RFL-AL-300W	Aluminum reflectors have a high reflectivity, they can effectively bounce light toward the desired area, maximizing illumination and improving overall lighting efficiency.	

INDUSTRIAL LED LIGHT

High Bay UFO | 150-240-300W

DLC MODELS



DLC			
DLC MODEL	PRODUCT ID	Primary Use	Classification
AE-IL-SB2-CA-150W-110-H-[Blank,(MS),(PIR),(BT)]	S-A238S5	High-Bay Luminaires for Commercial and Industrial Buildings	Premium
AE-IL-SB2-CA-200W-110-H-[Blank,(MS),(PIR),(BT)]	S-ZDR7CM		Premium
AE-IL-SB2-CA-240W-110-H-[Blank,(MS),(PIR),(BT)]	S-DR8HAI		Premium
AE-IL-SB2-CA-300W-110-H-[Blank,(MS),(PIR),(BT)]	S-B9FYXD		Premium
AE-IL-SB2-CA-300W-110-H-[Blank,(MS),(PIR),(BT)]-L	S-0M76CN		Premium

CONTROLS

EMERGENCY LED DRIVER

Ordered separately, field installed

BLD-UM60D-YYY (remote is optional) / BLD-REMOTECONTROL

To test the EMBB; press the button that is located on the EMBB or order the remote separately to test it remotely



The BLD-UMXXX-YYY series LED Emergency Driver is UL listed for field and factory installation, allowing a single LED fixture to operate in both normal and emergency modes. In case of power failure, it powers the fixture for up to 90 minutes, integrating a battery, charger, and converter in one unit. Supporting LED loads of 30-60W at 170VDC, its constant power design ensures consistent illumination during emergencies, making it ideal for 0-10V dimmable indoor industrial LED fixtures, such as flat panels, troffers, and UFO lights.

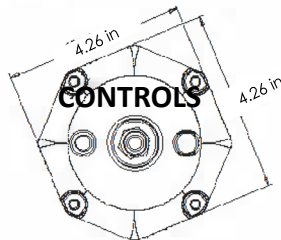
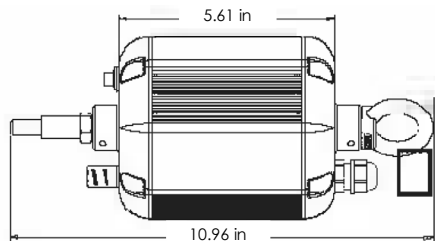

SPECIFICATIONS	
Input Voltage	100-347 Vac
Power Frequency	50/60HZ
Input Power	15W MAX
Output Voltage	170V Dc
Output Power	60W
Ambient Temperature	5°C to 50°C
	41°F to 122°F
Installation	Remote

CONTROLS

MOTION SENSOR

CODE	DESCRIPTION	PICTURE
AE-IL-SB2-CA-MSKIT	Plug in low-voltage microwave motion sensor	
AE-IL-SB2-CA-REMOTE-CTRL	Remote control for the motion sensor	

Factory mode

Factory Default Setting	
Sensitivity	100%
Hold on time	5 min
Daylight Sensor	ON
Dimming level	30%
Dimming time	30 min

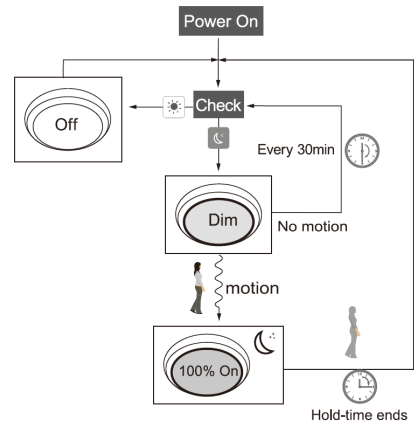

Area Coverage

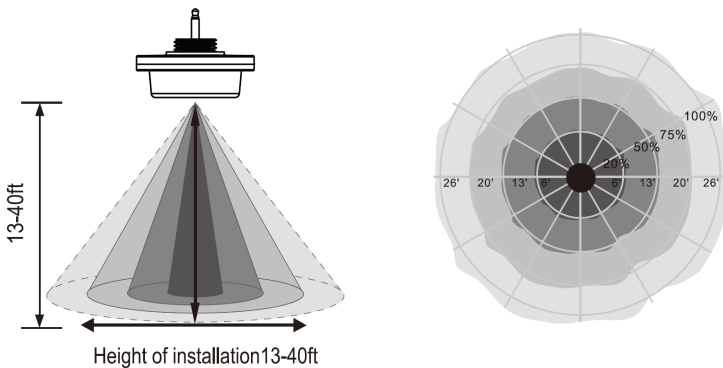

INDUSTRIAL LED LIGHT High Bay UFO | 150-240-300W

LUMEN ESTIMATE

Lumen output varies based on CCT and CRI. An estimate of lumen output of the various CCT/CRI combinations, use correction factors as per table below:

LUMEN ESTIMATE ADJUSTMENT FACTORS				
CCT	2700K	3000K	3500K	4000K
PREMIUM (80CRI)	0.96	1	1.03	1.06

PHOTOMETRIC DATA

PART NUMBER		ZONAL LUMEN SUMMARY			POLAR LUMINOUS INTENSITY	CONE DISTRIBUTION			
AE-IL-SB2-CA-150W-110-H-XX		Zone	Lumens	% Fixture	Direct Light	Center Beam Fc	Beam Width		
Wattage	150W	0-20°	3456.38	14.40		3.3ft	819 fc	7.7 ft	6.5 ft
CCT	3000K	0-30°	7839.2	32.70		6.7ft	199 fc	15.7 ft	13.1 ft
Distribution	110°	0-40°	13738.00	57.30		10.0ft	89.2 fc	23.4 ft	19.6 ft
		0-60°	22123.89	92.30		13.3ft	50.4 fc	31.2 ft	26.0 ft
		0-80°	23586.79	98.40		16.7ft	32 fc	39.2 ft	32.7 ft
		0-90°	22831.4	98.80		20.0ft	22.3 fc	46.9 ft	39.1 ft
						■ Vert. Spread: 99.1° ■ Horiz. Spread: 88.7°			

PART NUMBER		ZONAL LUMEN SUMMARY			POLAR LUMINOUS INTENSITY	CONE DISTRIBUTION			
AE-IL-SB2-CA-240W-110-H-XX		Zone	Lumens	% Fixture	Direct Light	Center Beam Fc	Beam Width		
Wattage	240W	0-20°	5549.53	15.20		3.3ft	1280 fc	7.0 ft	5.8 ft
CCT	3000K	0-30°	12765.11	35.10		6.7ft	311 fc	14.2 ft	11.7 ft
Distribution	110°	0-40°	22186.47	61.00		10.0ft	139 fc	21.2 ft	17.4 ft
		0-60°	33599.78	92.40		13.3ft	78.8 fc	28.2 ft	23.2 ft
		0-80°	35853.45	98.70		16.7ft	50 fc	35.5 ft	29.1 ft
		0-90°	36018.43	99.10		20.0ft	34.9 fc	42.5 ft	34.9 ft
						■ Vert. Spread: 93.4° ■ Horiz. Spread: 82.2°			

PART NUMBER		ZONAL LUMEN SUMMARY			POLAR LUMINOUS INTENSITY	CONE DISTRIBUTION			
AE-IL-SB2-CA-300W-110-H-XX		Zone	Lumens	% Fixture	Direct Light	Center Beam Fc	Beam Width		
Wattage	300W	0-20°	6886.46	15.6		3.3ft	1658 fc	8.2 ft	6.6 ft
CCT	3000K	0-30°	15316.64	34.6		6.7ft	402 fc	16.7 ft	13.3 ft
Distribution	110°	0-40°	26238.85	59.3		10.0ft	181 fc	24.9 ft	19.9 ft
		0-60°	41084.02	92.9		13.3ft	102 fc	33.1 ft	26.5 ft
		0-80°	43462.7	98.3		16.7ft	64.8 fc	41.6 ft	33.3 ft
		0-90°	43601.81	98.6		20.0ft	45.2 fc	49.8 ft	39.8 ft
						■ Vert. Spread: 102.5° ■ Horiz. Spread: 89.7°			

INDUSTRIAL LED LIGHT High Bay UFO | 150-240-300W

LUMEN ESTIMATE

Lumen output varies based on CCT and CRI. An estimate of lumen output of the various CCT/CRI combinations, use correction factors as per table below:

LUMEN ESTIMATE ADJUSTMENT FACTORS				
CCT	2700K	3000K	3500K	4000K
PREMIUM (80CRI)	0.96	1	1.03	1.06

PHOTOMETRIC DATA

PART NUMBER		ZONAL LUMEN SUMMARY			POLAR LUMINOUS INTENSITY	CONE DISTRIBUTION			
AE-IL-SB2-CA-240W-110-H-NAT		Zone	Lumens	% Fixture	Direct Light	Center Beam Fc	Beam Width		
Wattage	240W	0-20°	5211.47	14.7		3.3ft	1290 fc	7.9 ft	7.9 ft
CCT	3000K	0-30°	11139.07	31.3		6.7ft	313 fc	16.1 ft	16.1 ft
Distribution	110°	0-40°	18126.13	51		10.0ft	140 fc	24.0 ft	24.0 ft
Frosted lens		0-60°	29801.77	83.8		13.3ft	79.4 fc	31.9 ft	31.9 ft
		0-80°	34666.2	97.5		16.7ft	50.4 fc	40.0 ft	40.0 ft
		0-90°	35078.29	98.7	20.0ft	35.1 fc	47.9 ft	47.9 ft	
						■ Vert. Spread: 100.3° ■ Horiz. Spread: 100.3°			

PART NUMBER		ZONAL LUMEN SUMMARY			POLAR LUMINOUS INTENSITY	CONE DISTRIBUTION			
AE-IL-SB2-CA-240W-110-H-XX		Zone	Lumens	% Fixture	Direct Light	Center Beam Fc	Beam Width		
Wattage	240W	0-20°	4731.8	14.4		1.7ft	4442 fc	3.6 ft	3.7 ft
CCT	3000K	0-30°	10430.75	31.8		3.3ft	1179 fc	7.1 ft	7.2 ft
Distribution	110°	0-40°	17053.81	52		5.0ft	514 fc	10.7 ft	11.0 ft
Frosted lens		0-60°	26423.16	80.6		6.7ft	286 fc	14.4 ft	14.7 ft
		0-80°	30165.99	92		8.3ft	186 fc	17.8 ft	18.2 ft
Reflector with cover		0-90°	30652.81	93.5	10.0ft	128 fc	21.5 ft	21.9 ft	
						■ Vert. Spread: 94.0° ■ Horiz. Spread: 95.2°			

PART NUMBER		ZONAL LUMEN SUMMARY			POLAR LUMINOUS INTENSITY	CONE DISTRIBUTION			
AE-IL-SB2-CA-240W-110-H-XX		Zone	Lumens	% Fixture	Direct Light	Center Beam Fc	Beam Width		
Wattage	240W	0-20°	6361.7	20.1		1.7ft	6044 fc	3.1 ft	2.7 ft
CCT	3000K	0-30°	13514.25	42.7		3.3ft	1604 fc	6.0 ft	5.3 ft
Distribution	110°	0-40°	20774.75	65.6		5.0ft	699 fc	9.2 ft	8.0 ft
Frosted lens		0-60°	28407.8	89.7		6.7ft	389 fc	12.3 ft	10.8 ft
		0-80°	30606.33	96.7		8.3ft	254 fc	15.2 ft	13.3 ft
Reflector without cover		0-90°	30864.69	97.5	10.0ft	175 fc	18.3 ft	16.1 ft	
						■ Vert. Spread: 84.9° ■ Horiz. Spread: 77.6°			

OVERVIEW



Innovative Design

- Aluminum die-cast and heat sink to ensure superior thermal heat dissipation
- Polycarbonate lens protection for NEMA 4X ratings.



Multiple Options

- 3 sizes 150W-240W-300W.
- Power switchable.
- 3 CCT selectable; 30/35/40K
- Black & White Finish available

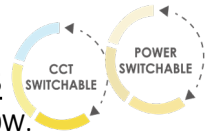

SIZE	POWER	LUMENS
150W	150/125/100W	22,500/18,750/15000 Lm
240W	240/200/150W	36,000/30,000/22,500 Lm
300W	300/240/200W	45,000/36,000/30,000 Lm



FEATURE

- Natatorium option:
With the frosted lens and stainless-steel hardware, the SB2 can be placed above pools



Mountings Available

- Hook Mount.
- Pendant using 3/4" adaptor.



ACCESSORIES

- Wire guard.
- Polycarbonate reflector and cover.
- Aluminum reflector.
- EMBB.
- Motion sensor.
- Metal chain.



Tests And Certifications