

# STELLER

## OUTDOOR LED LIGHT

### Architectural Full Cut-Off Wall Pack | Power & CCT Switchable

The Steller outdoor light features a durable aluminum die-cast housing with heat-dissipating fins. It is CCT switchable (30K/40K/50K), power switchable (40/60/80W), and distribution switchable (T2/T3/T4). Available in black, white, and bronze, it includes an integrated photocell, emergency battery backup, and an AUX arm for a motion sensor. Protected against dust, water jets, and impact for long-lasting outdoor use.

Applications: Garage door | Building contour | Parking lot

eralux®

	DATE	QTY	TYPE
PROJECT			
PN			
NOTES			



### DYNAMIC MENU

Order Information	<a href="#">Page 2</a>
Dimensions	<a href="#">Page 2</a>
Accessories	<a href="#">Page 3</a>
Photometric Data	<a href="#">Page 5</a>

[Install Instruction link](#)

### SPECIFICATIONS

Input Voltage	120-347V
Power Factor	>0.9
Total Harmonic Distortion	<20%
Dimming	0-10V dimming
CRI	70 CRI
CCT	<div style="display: flex; gap: 10px;"> <div style="border: 1px solid black; border-radius: 50%; width: 20px; height: 20px; background-color: yellow; display: flex; align-items: center; justify-content: center;">30K</div> <div style="border: 1px solid black; border-radius: 50%; width: 20px; height: 20px; background-color: lightblue; display: flex; align-items: center; justify-content: center;">40K</div> <div style="border: 1px solid black; border-radius: 50%; width: 20px; height: 20px; background-color: lightgreen; display: flex; align-items: center; justify-content: center;">50K</div> </div>
Efficacy	~145 lm/W
Power (W)	40/60/80W
Ambient Temperature Range	-40°C to 40°C
Mounting Options	Wall Mount
Fixture Finish	Black   Bronze   White 
Controls	Integrated Photocell Emergency Battery Back up Motion Sensor
Protection	IP65; water and dust resistance IK10; impact resistance 10kV surge protector
Lens	Polycarbonate lens
Distribution	Type 2/Type 3/Type 4 Switchable



### PRODUCT FEATURES



### PRODUCT CERTIFICATIONS



### SYSTEM WARRANTY – 5 YEARS

Eralux will warrant defective drivers, LEDs and boards for 5 years from the date of purchase. This warranty is valid only if the fixture is installed and used as per installation guides and specifications. If a defect is present, Eralux will send drivers and boards at no fee with a thorough replacement instructions along with instructions on the return of the defective parts back to Eralux.

### LUMEN MAINTENANCE – L80 at 100,000 hours

Rated for 80% initial lumen output at 100,000 hours of operation, operated at 25°C ambient temperature; per guidelines published by the Illuminating Engineering Society (IES).

## OUTDOOR LED LIGHT

Architectural Full Cut-Off Wall Pack | Power & CCT Switchable

### ORDERING GUIDE

WP-ST	-80W	-TCP	-CA		
WP-ST ERALUX STELLER Outdoor Wall Pack Light	-80W 40/60/80W 5,800/8,700/11,600lm	-TCP 30K/40K/50K Selectable	-CA 120-347V Input Voltage	[BLANK] 0-10V Dimming -PC <sup>1</sup> Photocell -MS <sup>2</sup> Motion Sensor -EM <sup>3</sup> Emergency Battery Backup -EMP <sup>1,3</sup> Emergency Battery Backup and Photocell -EMS <sup>2,3</sup> Emergency Battery Backup and Motion Sensor	-BK Black -BZ Bronze -WH White

Fixture Family	Power	CCT	Input Voltage	Control	Finish
----------------	-------	-----	---------------	---------	--------

### NOTES

1. Integrated photocell that can be turned on/off on field. 40ft max mounting height.
2. External motion sensor installed on arm.
3. Integrated emergency battery backup has 8W power output.
4. Driver type: 10V (wired).
5. Continuous dimming capability.
6. Dimming level: <10%.
7. Controls receptacle type: 3.5 mm phono jack.

### DIMENSIONS

AE-WP-ST-80W-TCP-CA-X-XX

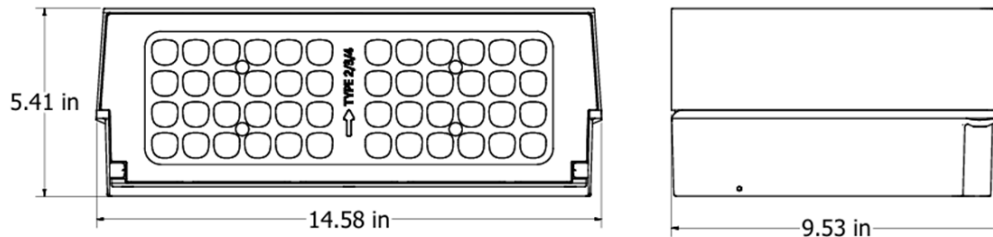

### BACK PLATE INSTALLATION

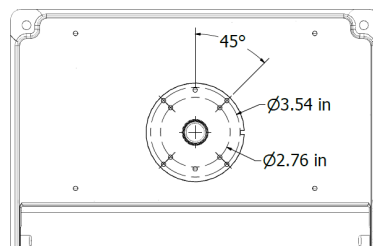

## OUTDOOR LED LIGHT

Architectural Full Cut-Off Wall Pack | Power & CCT Switchable

### ACCESSORIES

#### EMERGENCY LED DRIVER



SPECIFICATION	
Input Voltage	100-347Vac
Input Current	100mA max
Recharge Time	24Hrs
Discharge Time	1.5Hrs
Output Power	8W max
Output Voltage	25-58 V DC
Installation	Integrated

Introducing a UL-listed emergency lighting solution for the US and Canada, featuring high output voltage, self-testing, and overcharge/discharge protection. Compliant with UL924 and CSA C22.2 NO.141, it's suitable for field or factory installation and integrates seamlessly with LED drivers. With low energy consumption and Title20 compliance, it offers 8W emergency power options, a quick 24-hour recharge time, and 1.5-hour discharge time.

#### DIMENSIONS

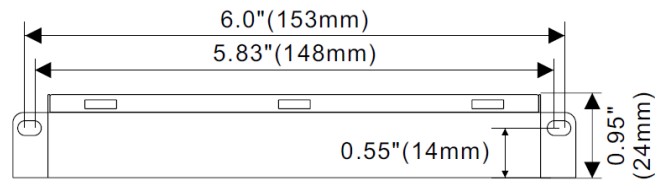
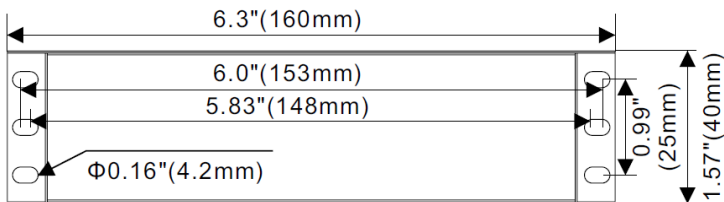

## OUTDOOR LED LIGHT

Architectural Full Cut-Off Wall Pack | Power & CCT Switchable

### ACCESSORIES

#### MOTION SENSOR

CODE	DESCRIPTION	PICTURE
AE-IL-SB2-CA-MOTIONSENSOR	Plug-in low-voltage microwave motion sensor	
AE-IL-SB2-CA-REMOTE-CTRL	Remote control for motion sensor	
WP-MS/PC-ARM	Arm for motion sensor	

#### FACTORY MODE

Factory Default Setting	
Sensitivity	100%
Hold on time	5 min
Daylight Sensor	ON
Dimming Level	10%
Dimming Time	30 min

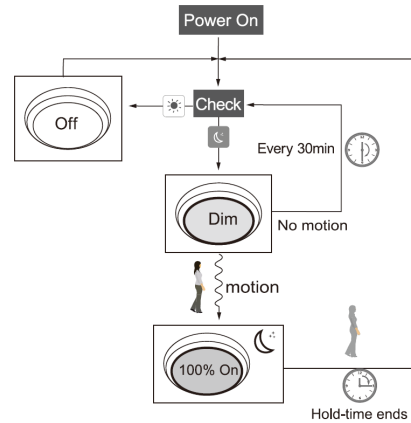

#### AREA COVERAGE

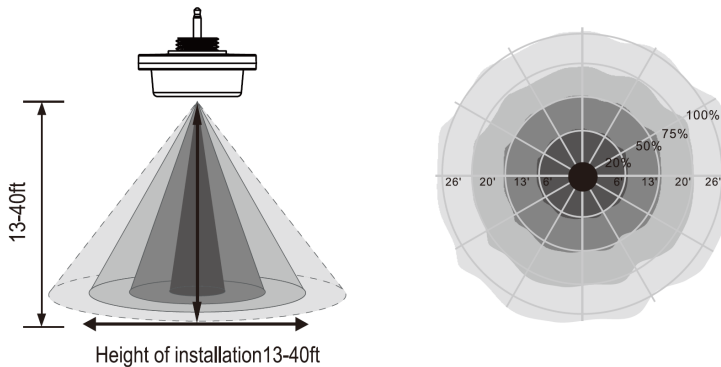

## OUTDOOR LED LIGHT

Architectural Full Cut-Off Wall Pack | Power & CCT Switchable

### PHOTOMETRIC DATA

PART NUMBER		ZONAL LUMEN SUMMARY			POLAR LUMINOUS INTENSITY	CONE DISTRIBUTION			ISO FOOTCANDLE PLOT
AE-WP-ST-80W-TCP-CA-XX-XX		Zone	Lumens	% Fixture		Center Beam fc	Beam Width	Distances are in units of mounting height (15ft)	
Wattage	80W	0-20°	1299.84	10.2		<p>Vert. Spread: 78.2° Horiz. Spread: 130.2°</p>			
CCT	4000K	0-30°	2848.55	22.4					
Distribution	T2	0-40°	4880.48	38.4					
		0-60°	9642.92	75.9					
		0-80°	12312.27	96.9					
		0-90°	12434.59	97.9					

PART NUMBER		ZONAL LUMEN SUMMARY			POLAR LUMINOUS INTENSITY	CONE DISTRIBUTION			ISO FOOTCANDLE PLOT
AE-WP-ST-80W-TCP-CA-XX-XX		Zone	Lumens	% Fixture		Center Beam fc	Beam Width	Distances are in units of mounting height (15ft)	
Wattage	80W	0-20°	1230.07	9.9		<p>Vert. Spread: 97.6° Horiz. Spread: 136.3°</p>			
CCT	4000K	0-30°	2691.44	21.6					
Distribution	T3	0-40°	4618.54	37.1					
		0-60°	9280.53	74.5					
		0-80°	12073.7	97					
		0-90°	12188.02	97.9					

PART NUMBER		ZONAL LUMEN SUMMARY			POLAR LUMINOUS INTENSITY	CONE DISTRIBUTION			ISO FOOTCANDLE PLOT
AE-WP-ST-80W-TCP-CA-XX-XX		Zone	Lumens	% Fixture		Center Beam fc	Beam Width	Distances are in units of mounting height (15ft)	
Wattage	80W	0-20°	1098.12	8.8		<p>Vert. Spread: 118.9° Horiz. Spread: 138.0°</p>			
CCT	4000K	0-30°	2419.23	19.4					
Distribution	T4	0-40°	4200.24	33.8					
		0-60°	8910.85	71.6					
		0-80°	12049.44	96.9					
		0-90°	12177.53	97.9					

#### T2

Wide, more asymmetric illuminance

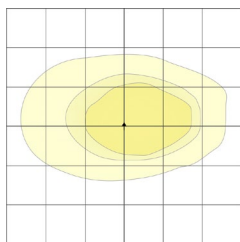

#### T3

Wide slightly forward asymmetric illuminance pattern

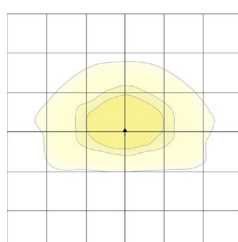

#### T4

Wide more forward asymmetric illuminance pattern

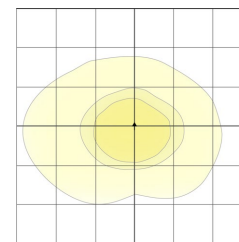

## OUTDOOR LED LIGHT

Architectural Full Cut-Off Wall Pack | Power & CCT Switchable

### OVERVIEW



#### Innovative Design

- Aluminum die-cast housing and fins for better heat dissipation



#### Multiple Options

- CCT switchable ; 30/40/50K
- Black, bronze or white finish
- Power switchable

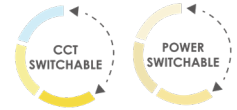

#### Protection

- Protected against dust ingress.
- Protected against water jets
- Impact resistant
- 10 kV surge protector



#### Accessories

- Integrated photocell
- Integrated emergency battery
- Plug-in motion sensor



Emergency backup battery



Integrated Photocell



Motion Sensor



#### Tests And Certifications

