

# THALASSA ET6161

## OUTDOOR PRODUCTS

Square Sconce



eralux®



The Thalassa outdoor surface mounted square LED fixture was created with a sleek design deliberately, so it could blend in with many different outdoor building styles. The Thalassa also has an impressive efficacy of 95 LPW providing performance as well as elegance in the install environment. Finally, this product is a complete aluminum die cast offering an unparalleled sense of finesse, fixture strength and quality.

DATE					
PROJECT NAME					
<b>TYPE</b>					
QTY					
ORDERING CODE	ET6161-C80	-	-	-80	-DMG

### OPERATING & ELECTRICAL

INPUT VOLTAGE	120-277Vac
POWER FACTOR	0.9
DIMMING	0-10V external dimming down to 10% (with DMG/SDMG option)
TOTAL HARMONIC DISTORTION (THD)	<20%

### PERFORMANCE

LUMENS PER WATT	~95 LPW at 80CRI
POWER CONSUMPTION	40W, 80W
BEAM ANGLE	8°, 18°, 36°, 62°

### WARRANTY

#### SYSTEM WARRANTY – 5 YEARS

Eralux will warrant defective drivers, LEDs and boards for 5 years from the date of purchase. This warranty is valid only if the fixture is installed and used as per installation guides and specifications. If a defect is present, Eralux will send drivers and boards at no fee with a thorough replacement instructions along with instructions on the return of the defective parts back to Eralux.

#### LUMEN MAINTENANCE – L85 at 50,000 hours

Rated for 85% initial lumen output at 50,000 hours of operation, operated at 25°C ambient temperature; per guidelines published by the Illuminating Engineering Society (IES). (L85 at 50,000 hours)

### APPLICATION CONDITION

AMBIENT TEMPERATURE RANGE	-25 to 50°C
Protection	IP65

### COMPATIBLE MOUNTING

MOUNTING	Wall mount
----------	------------

### MECHANICAL & HOUSING

HOUSING	Aluminum die cast
LENS	Highly durable, shatterproof tempered glass lens ensures high efficiency light output for a clean, evenly illuminated surface with minimal glare.
FINISH	ERALUX white, black, gray, bronze, silver (RAL9006) powder coat finish
POWER SUPPLY	Factory wired electronic LED driver
LED BOARD	COB

# THALASSA ET6161

OUTDOOR PRODUCTS

Square Sconce

DATE						
PROJECT NAME						
<b>TYPE</b>						
QTY						
ORDERING CODE	ET6161-C80	-	-	-80	-	-DMG

## ORDERING GUIDE

EXAMPLE: ET6161-C40-3-8-80-W-DMG

FIXTURE FAMILY	POWER	CCT	BEAM ANGLE	CRI	FINISH	CONTROLS
<b>ET6161</b>	<b>-C80</b>	<b>-</b>	<b>-</b>	<b>-80</b>	<b>-</b>	<b>-DMG</b>
<b>ET6161</b> ERALUX Thalassa ET6161 outdoor wall mounted square sconce fixture	<b>-C80</b> 80 watts: 7400 lumens	<b>-3</b> 3000K CCT	<b>-8</b> 8° beam angle	<b>-80</b> 80 CRI	<b>-B</b> Black powder coat finish	<b>-DMG</b> 0-10V external dimming down to 10%
		<b>-4</b> 4000K CCT	<b>-18</b> 18° beam angle		<b>-W</b> White powder coat finish	
			<b>-36</b> 36° beam angle		<b>-S</b> Silver (RAL9006) powder coat finish	
					<b>-G</b> Gray (RAL7012) powder coat finish	
		<b>-5</b> 5000K CCT	<b>-62</b> 62° beam angle		<b>-Z</b> Mineral bronze powder coat finish	

# THALASSA ET6161

OUTDOOR PRODUCTS

Square Sconce

DATE					
PROJECT NAME					
<b>TYPE</b>					
QTY					
ORDERING CODE	ET6161-C80	-	-	-80	-DMG

## DIMENSIONS

EXAMPLE: ET6161-C40-3-8-80-W-DMG

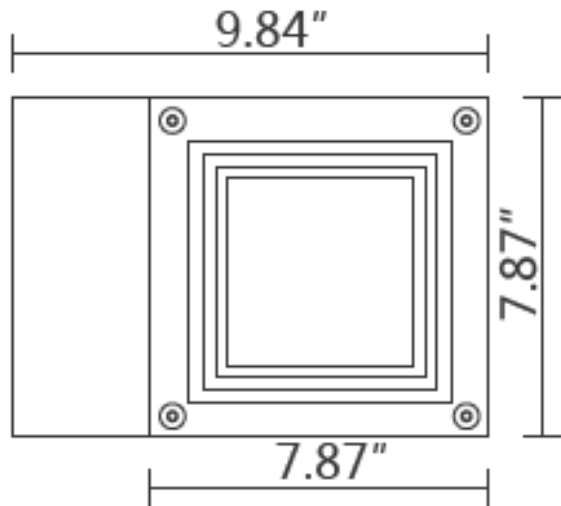
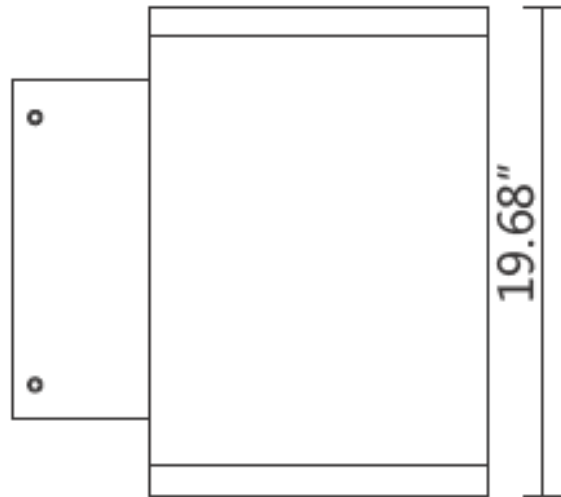
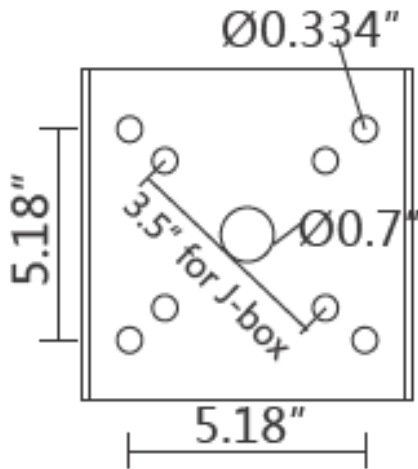

# THALASSA ET6161

OUTDOOR PRODUCTS

Square Sconce

DATE					
PROJECT NAME					
<b>TYPE</b>					
QTY					
ORDERING CODE	ET6161-C80	-	-	-80	-DMG

## LUMEN ESTIMATE

Lumen output varies based on CCT and CRI. An estimate of lumen output of the various CCT/CRI combinations, use correction factors as per table below:

LUMEN ESTIMATE ADJUSTMENT FACTORS				
CCT	2700K	3000K	3500K	4000K
NORMAL (80CRI)	0.94	1	1.02	1.03

## PHOTOMETRIC DATA

**GRID DISTANCES WITH A MOUNTING HEIGHT OF 10' AFG**

**POLAR LUMINOUS INTENSITY GRAPHS**

ET6061-C40-3-8-80

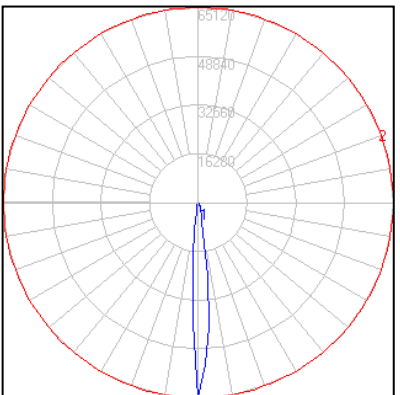
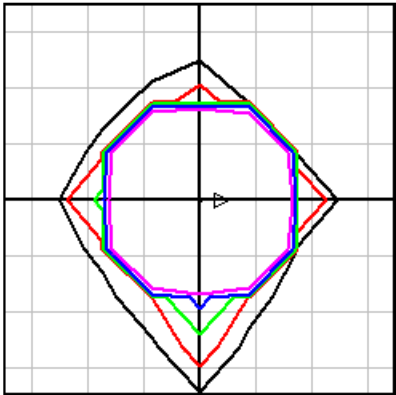

ET6061-C40-3-62-80

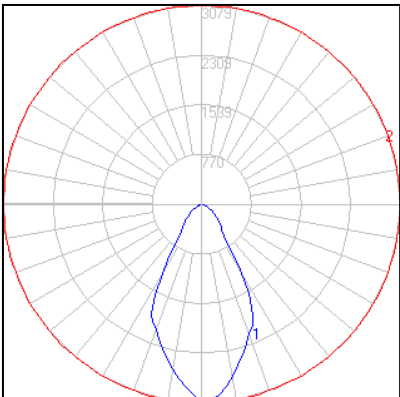
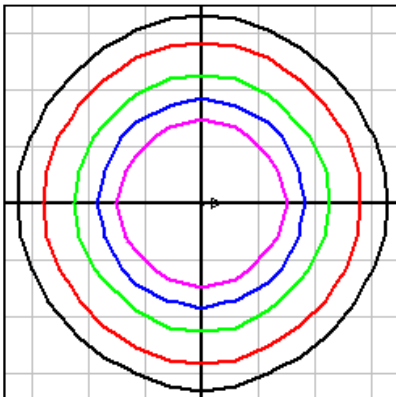

# THALASSA ET6161

OUTDOOR PRODUCTS

Square Sconce

DATE					
PROJECT NAME					
<b>TYPE</b>					
QTY					
ORDERING CODE	ET6161-C80	-	-	-80	-DMG

## ACCESSORIES

Ordered separately, field installed

### EMERGENCY LED DRIVER (BLD-CM20N-480800-8W)

BLD-CM20N-480800-8W

OUTPUT POWER : 8 WATTS



- Easy Wiring
- Certified For CA Title 20
- Constant Power Performance

BLD-CM20N-480800-8W LED Emergency Driver is UL listed for field and factory installation that allows the same LED fixture to be used for both normal and emergency operation. In the event of a power failure, the emergency driver switches to emergency mode and operates the fixture for 90 minutes. The unit contains a battery, charge, and converter circuit in a single enclosure. This module will operate a LED array load at 8W with constant power at a rated output voltage of 25-48 VDC. The constant power design of BLD-CM20N-480800-8W maintains the output wattage to the LED array, providing consistent illumination for the entire emergency runtime. Its slim shape is ideal for use indoor or outdoor LED lighting fixtures, such as linear lights, wall packs or sconces, etc.

## DIMENSIONS (inches and mm)

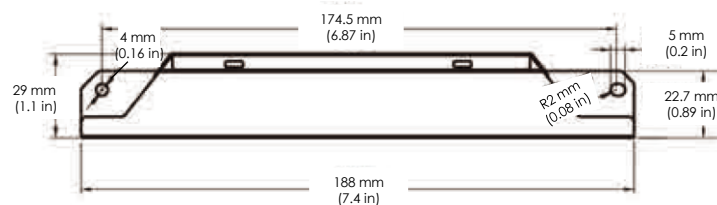
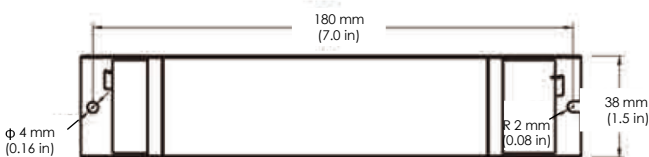

# THALASSA ET6161

OUTDOOR PRODUCTS

Square Sconce

DATE						
PROJECT NAME						
<b>TYPE</b>						
QTY						
ORDERING CODE	ET6161-C80	-	-	-80	-	-DMG

## OVERVIEW

### PREMIUM MATERIALS

Constructed from aluminum die-cast enhancing thermal heat dissipation while providing excellent figure strength.

### LIGHT SOURCE

Both up-light and downlight outdoor sconce.



### MULTIPLE BEAM ANGLES

Customize your fixture with a unique set of beam angles in the up light or downlight orientation with the option to having a 20-degree tilt towards the wall.

### MULTIPLE FINISH OPTIONS

Select from black, white, or silver powder coat anti-cracking finishes to accent your project space.

### CRI

80 CRI provides greater rendering allowing for a more natural light look.