

ARIA

Lighting Control
ARIA LITE | ARIA PLUS



eralux®

DATE	QTY	ACC. QTY	TYPE
PROJECT			
PN			
ACCESSORY PN			
NOTES			



Aria brings the freedom of effortless, intuitive control to your lighting system. Aria adapts to your needs, providing seamless automation and personalized lighting experiences.

Experience lighting that flows as naturally as the air you breathe.

Whether you choose Aria Lite for simple, motion-activated lighting, or Aria Plus for advanced Bluetooth control and scheduling, Aria is available for multiple applications; low bay, high bay, and ceiling mount.

ARIA LITE

ARIA LITE is a standalone lighting control solution that can be configured to different profiles for each fixture, utilize daylight harvesting, and task tuned to optimize occupant comfort and energy efficiency.

ARIA LITE controls are simple fixture installed controls that operate individually without Bluetooth



Example:

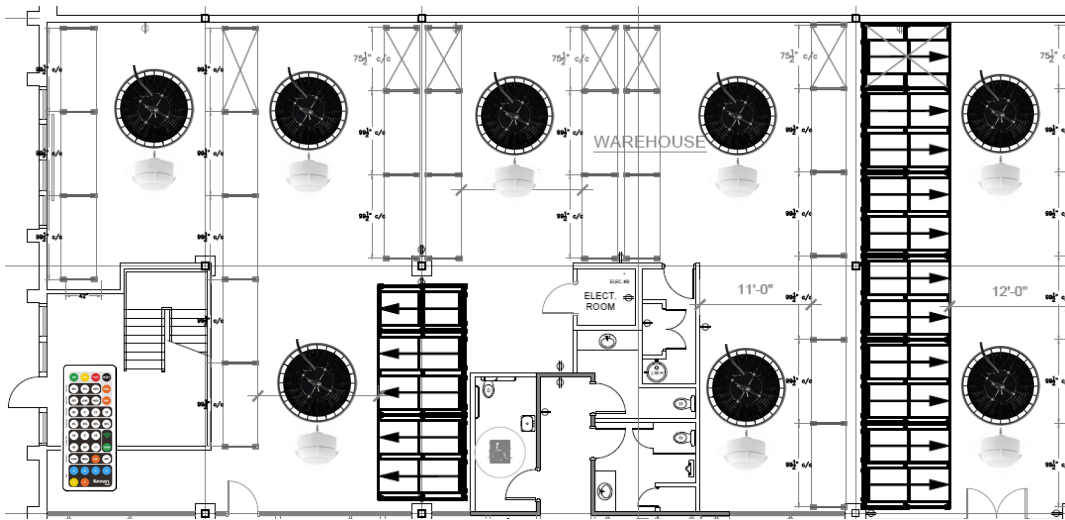

Controls

Dimming

Trim Level

Sensitivity

Hold Time

Daylight Harvesting

Standby Dim

Standby Time

NOTES

- Each fixture requires one sensor
- Remote control can program one fixture at a time

High Bay Sensor



PIR sensor combines occupancy sensing with photocell

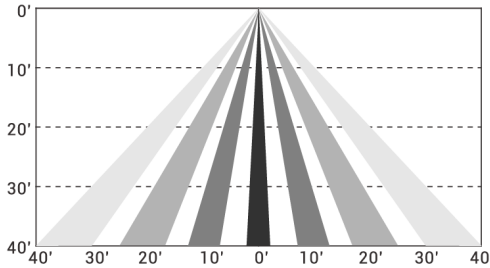
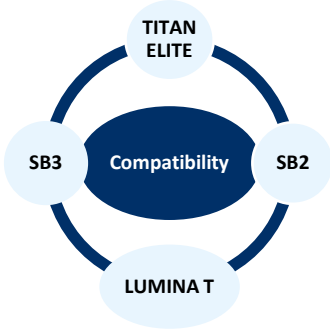

Parameters	
Input Voltage	12V
Input Current	8mA
Application	Indoor Outdoor
Detection Range	40-80ft
Mounting Height	20-40ft
Operating Temperature	-30°C to 70°C
IP Rating	IP66
Installation	Pug in – AUX base
Remote Controller	RM51 IR
Detection	On/off PIR + DLH

Low Bay Sensor



Compact Size microwave sensor combines occupancy sensing with photocell

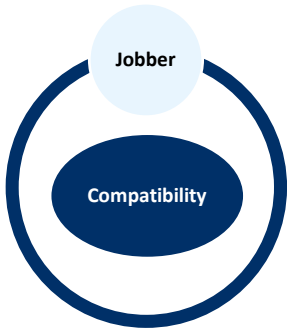

Suggested Mounting Height: 15-20ft

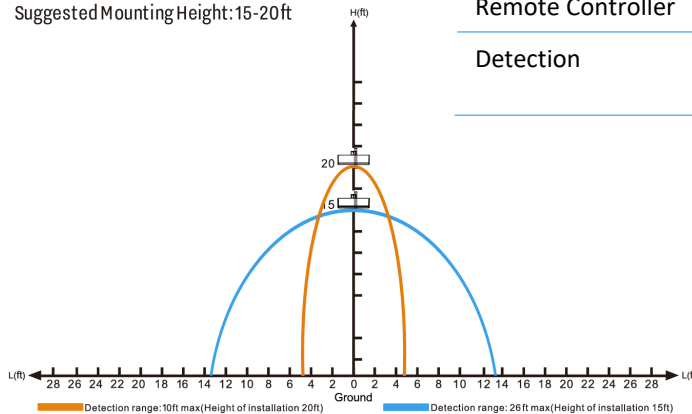

Parameters	
Input Voltage	12V
Input Current	40mA
Application	Indoor
Detection range	26ft
Mounting Height	20ft Max
Operating Temperature	-30°C to 55°C
IP Rating	IP20
Installation	Integrated
Remote Controller	RM51 IR
Detection	On/Off Microwave

Commercial Sensor



The IFS06R is a compact PIR (Passive Infrared) sensor that combines motion detection with daylight control. It works with 0-10V dimming LED drivers to enable automatic lighting, turning fixtures on and off based on occupancy and available daylight.

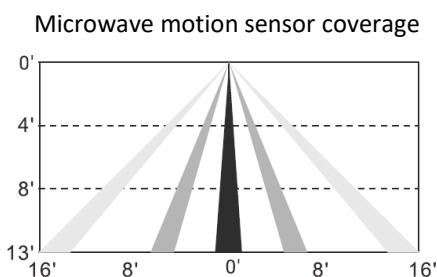
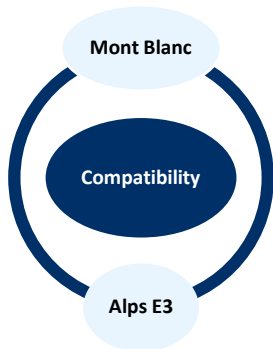

Parameters	
Input Voltage	12V
Input Current	8mA
Application	Indoor Outdoor
Detection Range	32ft Max
Mounting Height	15ft Max
Operating Temperature	-30°C to 65°C
IP Rating	IP20
Installation	Pug in – BH4 base
Remote Controller	RM51 IR
Detection	PIR DLH

Remote Control



The RM51 Remote is used to program the configurations of the ARIA Lite motion sensors

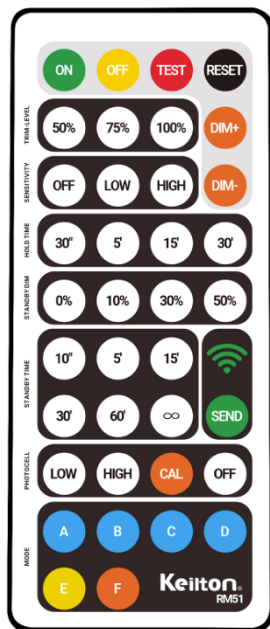

Parameters	
Default Mode (Reset)	Motion → 100%, No Motion ≥ 5 min → DIM to 30%, No Motion ≥ 60 min → Off.
DIM+ / DIM-	Control the dimming of the fixture
Trim Level	Set maximum threshold value at 50%, 75%, or 100%.
Sensitivity	OFF (PIR OFF, Enter PC ON/OFF function) / LOW 50% / HIGH 100%
Hold Time	Time of no occupancy after the fixture goes to standby: 30s / 5 min / 15 min / 30 min
Standby DIM	Select any standby dim level: 0% / 10% / 30% / 50%
Standby Time	10s / 5 min / 15 min / 30 min / 1h / ∞. "∞" means the standby time is infinite, and the fixture is effectively controlled by the daylight sensor.
Photocell	LOW (1fc) / HIGH (50fc) / CAL (Collects the current Lux Level) ON.

ARIA PLUS

A Bluetooth-controlled LED light fixture with motion sensors and scheduling offers convenience and energy efficiency. Users can wirelessly control the lights via Bluetooth using a smartphone app (Kielton+Autoni) and program lighting schedules for automatic on/off at set times. This system is ideal for residential, commercial, and industrial settings, providing smart lighting solutions and energy savings.

Autonomous Lighting Behavior	Sensors adjust light levels based on occupancy, task tuning, daylight harvesting, and configurable lighting profiles
Manual Lighting Behavior	The switch turns lights on/off or to preset dim levels
Daylight Harvesting	Fixture lights are dimmed or turned off in response to daylight
Occupancy or Vacancy Behavior	Configure sensors in a room for manual-on (vacancy switch) or auto-on (occupancy switch)
Energy Savings	Depending on occupancy patterns, available natural light and lighting schedule, savings may be as high as 65 percent
Multiple Switches per Room	Add switches at each room entry point to control room lights
Personalize and Reconfigure	Customize individual light levels and easily add or remove sensors from a group anytime
Easy Install	Less labor cost compared to wired lighting solutions due to wireless communications between the switch and sensors

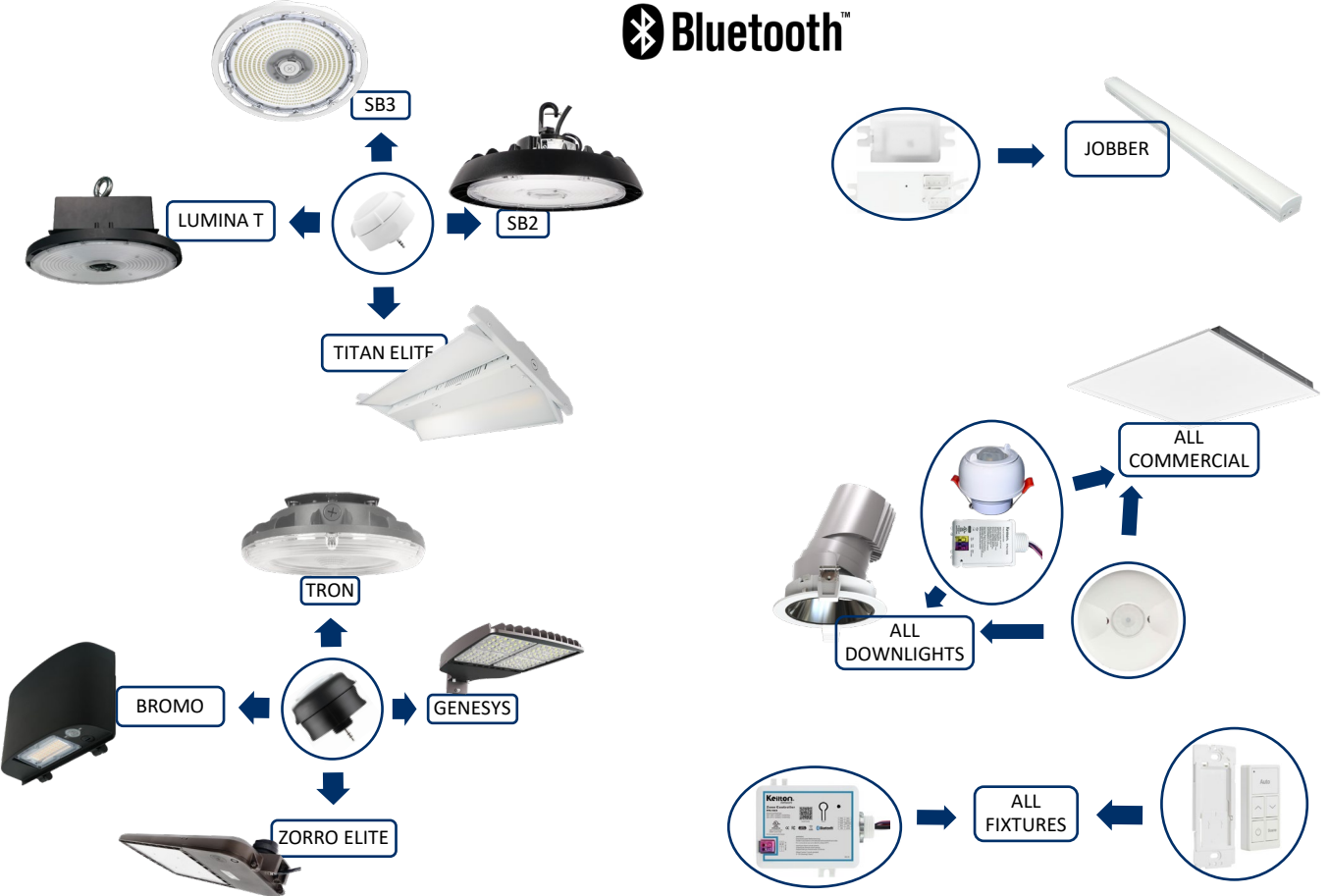

High Bay Sensor

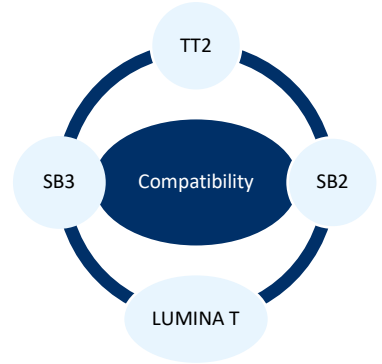

low voltage high bay sensors are ideal for Luminaire Level Lighting Control (LLLC/NLC5) applications.

Parameters	
Input Voltage	12V
Input Current	50mA Max
Application	Indoor
Detection Range	40-80ft
Mounting Height	20-40ft
Bluetooth range	100ft Max
Operating Temperature	-30°C to 55°C
IP Rating	IP40
Installation	Plug in – AUX base
Detection	PIR DLH

Features
Plug and Play with sensor port pre-installed
Bluetooth network technology
Designed for High Bay applications
AlgoH2 algorithm enhances performance in high bay applications
Built-in analog PIR sensor
Daylight harvesting available
1 per fixture
Schedule lighting
On/off with dimming option

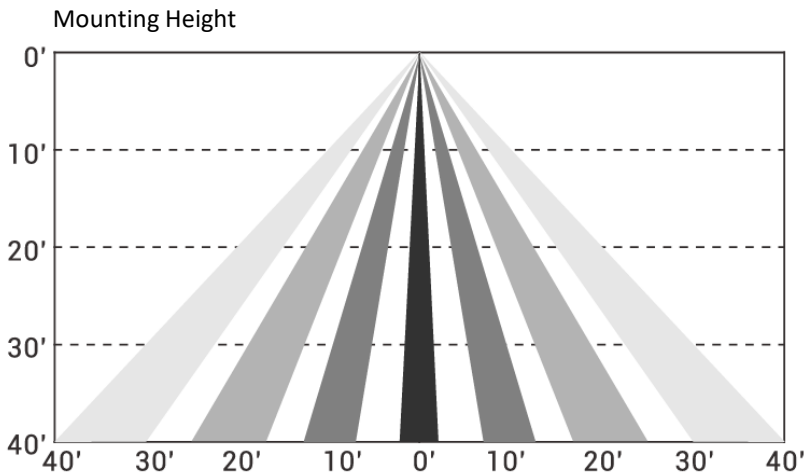

High Bay Sensor – Outdoor Applications

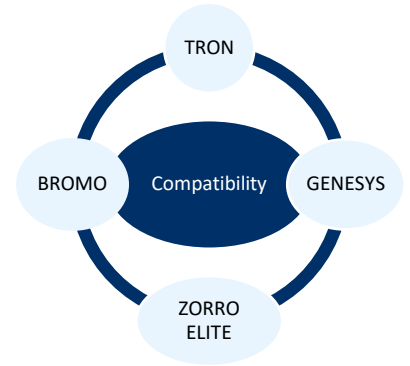

low voltage high bay sensors are ideal for Luminaire Level Lighting Control (LLLC) applications, particularly outdoor environments.

Parameters	
Input Voltage	12V
Input Current	50mA Max
Application	Outdoor
Detection Range	40-80ft
Mounting Height	20-40ft
Bluetooth range	328ft Max
Operating Temperature	-30°C to 55°C
IP Rating	IP66
Installation	Plug in – AUX base
Detection	PIR DLH

Features
Plug and Play with sensor port pre-installed
Bluetooth network technology
Designed for High Bay outdoor applications
AlgoH2 algorithm enhances performance in high bay applications
Built-in analog PIR sensor
Daylight harvesting available
1 per fixture
Schedule lighting
On/off with dimming option

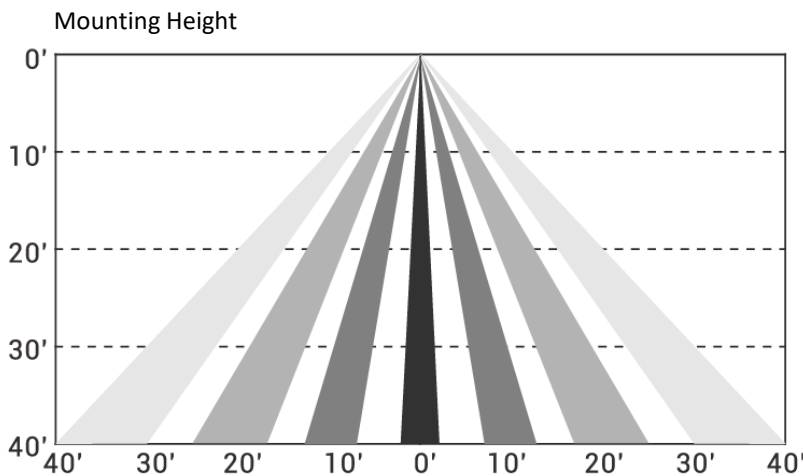

Low Bay Sensor



This sensor extends the capabilities of a host controller device by providing Microwave Occupancy detection with adjustable sensitivity inputs. It is designed to operate with the FA102 Bluetooth low-voltage luminaire controller.

Parameters	
Input Voltage	12V
Input Power	0.1W
Application	Indoor
Detection Range	20-40ft
Mounting Height	8-20ft
Operating Temperature	-30°C to 55°C
IP Rating	IP20
Installation	Integrated
Detection	Microwave

- | Features |
|----------------------------------------------------|
| Microwave occupancy sensor |
| Supports setting a delay time and bi-level dimming |
| Sensitivity adjustment from 0-100% |
| Designed for low bay application |
| Daylight harvesting available |
| Needs FA102 for Bluetooth network technology |



The FA102 Integrated Fixture Adapter enables Luminaire Level Lighting Control (LLLC) capabilities in a miniature design with integrated “sensor-ready” functionality.

Parameters	
Input Voltage	12V
Input Power	0.5W
Application	Indoor
Bluetooth Transmit	200ft MAX
Operating Temperature	-30°C to 55°C
IP Rating	IP20
Installation	Integrated
Radio	Bluetooth
Bluetooth Transmit	200ft

- | Features |
|---------------------------------------------------------------------------------------------|
| Integral Bluetooth module |
| Designed for integration into luminaires to provide luminaire level lighting control (LLLC) |
| 0-10V output |
| Needs Sensor and FC cable |
| Schedule lighting |
| On/off with dimming option |

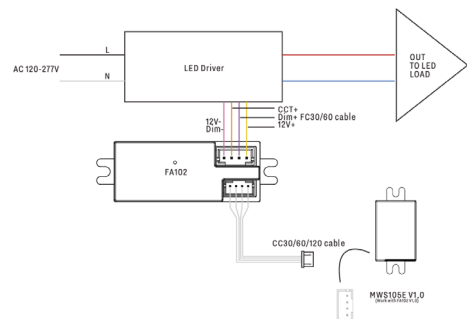
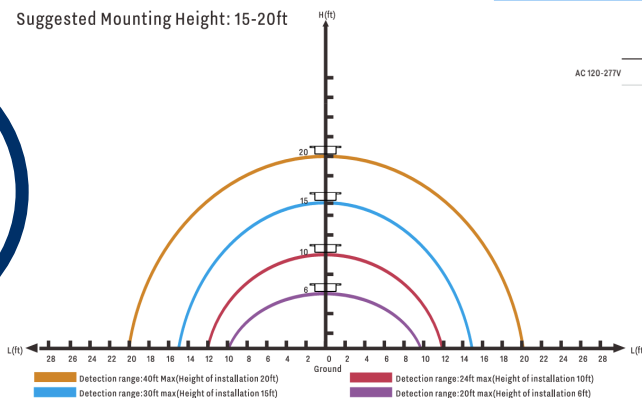
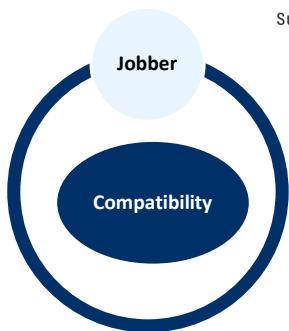

Application

Warehouse: High bay / Low bay application

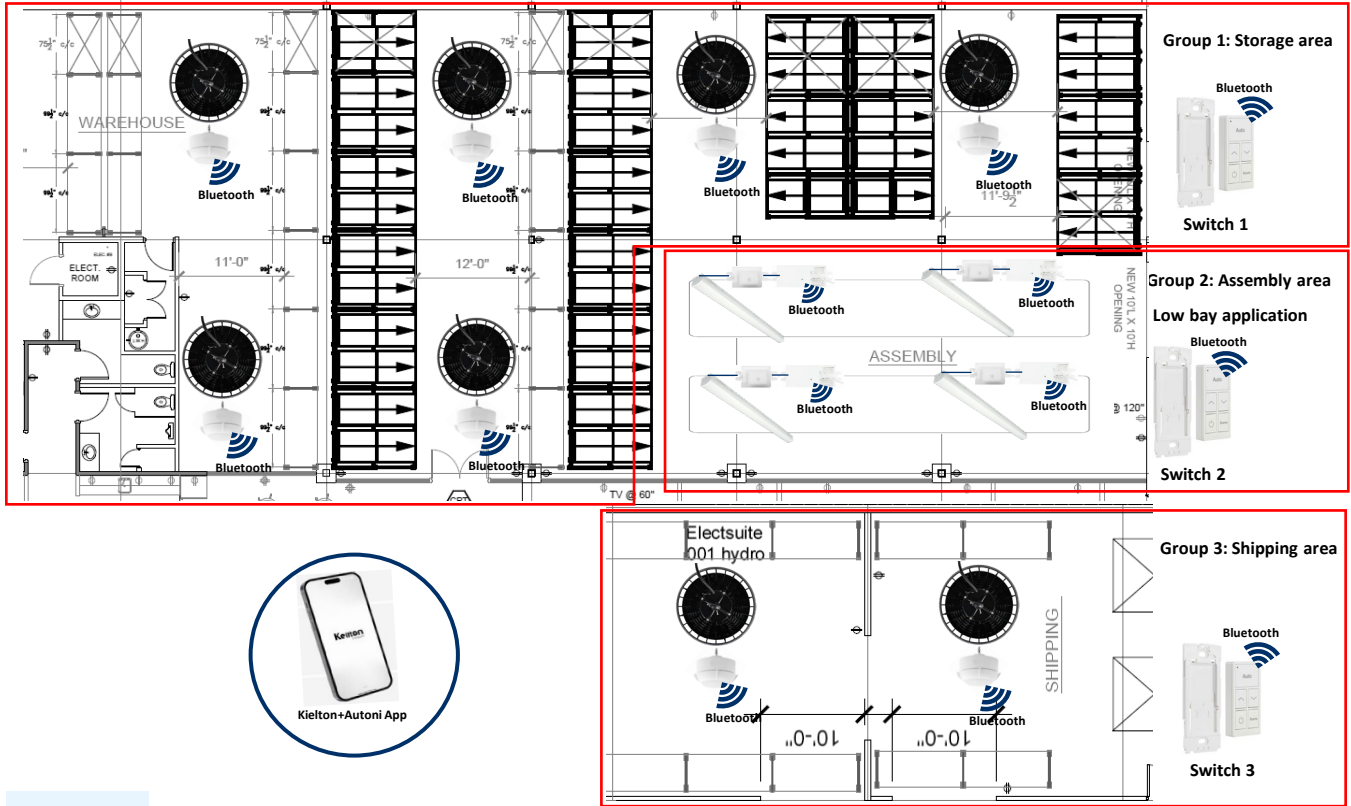

NOTES

- One sensor per fixture
- Download Keilton application to control the fixture
- Group 1 can be storage area assign the switch 1 to control the light fixture (up to 100) in this zone
- Group 2 can be assembly area controlled by switch 2
- Group 3 the motion sensor “MWS105E” needs “FA102” for Bluetooth connection
- The three groups can have different lighting schedule
- Motion sensor and day light harvesting parameters can be different for each group as required
- Dimming value can be adjusted for each group

Lights

- Add unlimited light/motion sensors in the app, in one or multiple zones

Groups

- Group up to 100 light in one group
- Turn on/off and dim all the light simultaneously
- Specify motion sensor and day light harvesting parameters

Switches

- Add wall Switch to the system to control the group (on/off | dimming | Scene | Auto)

App

Scenes

- Create desired scene with required brightness.

More → Schedule

- Create multiple lighting schedule to turn the lights on or off or activate the motion sensor/photocell

Menu



Room Sensor

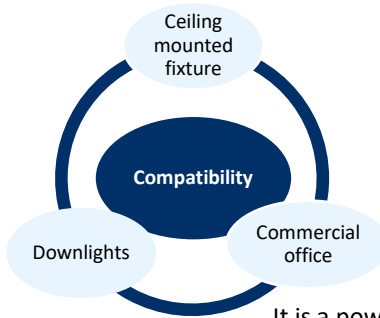

It is a low-voltage, dual-tech ceiling mount room sensor that combines PIR and ultrasonic technologies to provide high accuracy and wide coverage.

Parameters	
Input Voltage	12V
Application	Indoor / Outdoor
Detection Range	50ft Max
Mounting Height	20ft Max
Bluetooth Transmit	200ft Max
Operating Temperature	-30°C to 55°C
IP Rating	IP66
Installation	Ceiling (2.2" cutout)
Detection	PIR DLH

- ### Features
- Powered by luminaire controllers (PPA103S)
 - Easily installed to any ceiling
 - PIR technology
 - Daylight harvesting available
 - Schedule lighting
 - On/off with dimming option

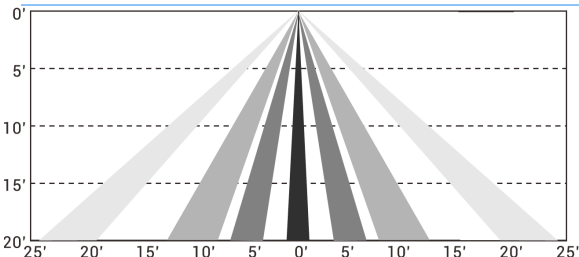

It is a power pack that provides 12V DC output to power sensors and switching for non-dim-to-off LED drivers. The PPA103S also provides a 0-10V dimming wire for bi-level motion control and relay output.

Parameters	
Input Voltage	120-347V
Output Power	360W
Application	Indoor
Bluetooth Transmit	200ft MAX
Operating Temperature	-30°C to 55°C
IP Rating	IP20
Installation	Flat Surface
Knockout	½ inch US standard

- ### Features
- high-efficiency switching power supply and a 6A relay
 - Well-suited for applications that require high-voltage switching through low voltage controls
 - Offers 12VDC, 200mA to power the sensor
 - Needs Sensor
 - Can power up to 360W total power fixtures (ex: 10 of 36W fixtures)

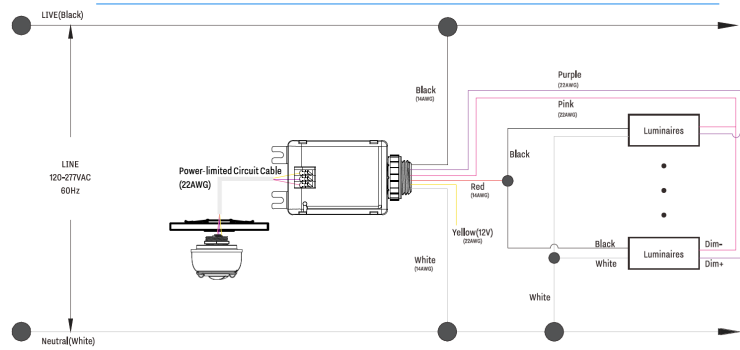

Application

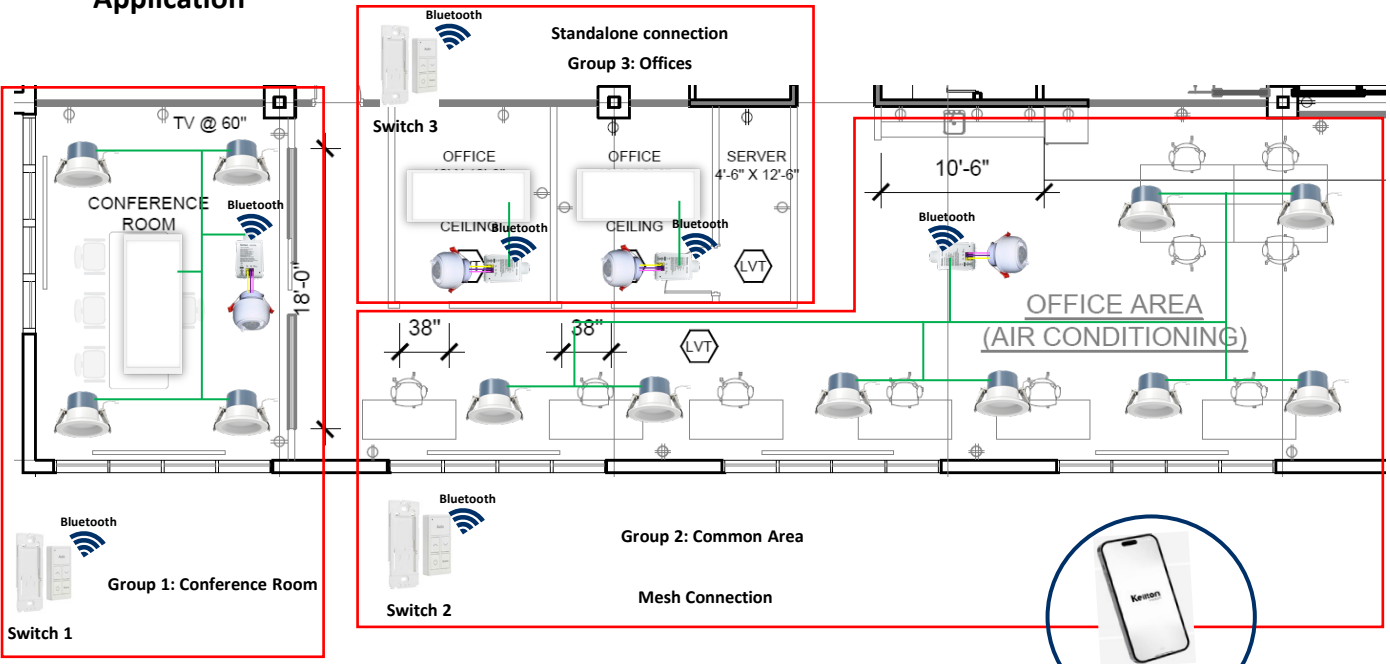

NOTES

- One sensor per one power pack (fixture controller)
- Connect up to 360W total power fixtures to one power pack which are controlled by one sensor
- Download Kielton application to control the fixture
- Group 1 can be conference room with downlights and flat panel assign the switch 1 to control the light fixture in this zone
- Group 2 can be Common Area with downlights controlled by switch 2
- Group 3 is Offices with one flat panel and motion sensor; stand alone connection
- The three groups can be controlled by one switch if needed.
- The three groups can have different lighting schedule
- Motion sensor and day light harvesting parameters can be different for each group as required
- Dimming value can be adjusted for each group

Lights

- Add unlimited light/motion sensors in the app, in one or multiple zones

Groups

- Group up to 100 light in one group
- Turn on/off and dim all the light simultaneously
- Specify motion sensor and day light harvesting parameters

Switches

- Add wall Switch to the system to control the group (on/off | dimming | Scene | Auto)

App

Scenes

- Create desired scene with required brightness.

More → Schedule

- Create multiple lighting schedule to turn the lights on or off or activate the motion sensor/photocell

Menu



Room Sensor

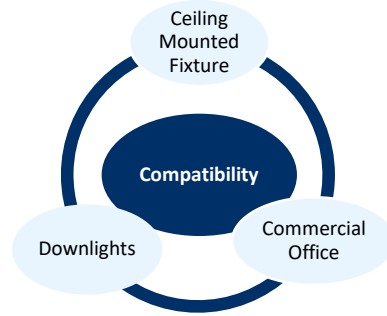

The CS107S is a line-voltage PIR occupancy/vacancy sensor with an integrated photocell that provides an adjustable ambient light "Hold-OFF" feature.

Parameters	
Input Voltage	120-277V
Application	Indoor
Output Power	800W @ 120V
Detection Range	10-20ft
Mounting Height	8-10ft
Bluetooth Transmit	100ft Max
Operating Temperature	0°C to 55°C
IP Rating	IP20
Installation	Ceiling
Detection	On/off PIR DLH

Features
Configurable for occupancy or vacancy mode
600 sq ft room coverage
Wireless Bluetooth connection
Daylight harvesting available
Can power up to 800W total power fixtures (ex: 100 of 8W fixtures)
Schedule lighting
On/off with no dimming option

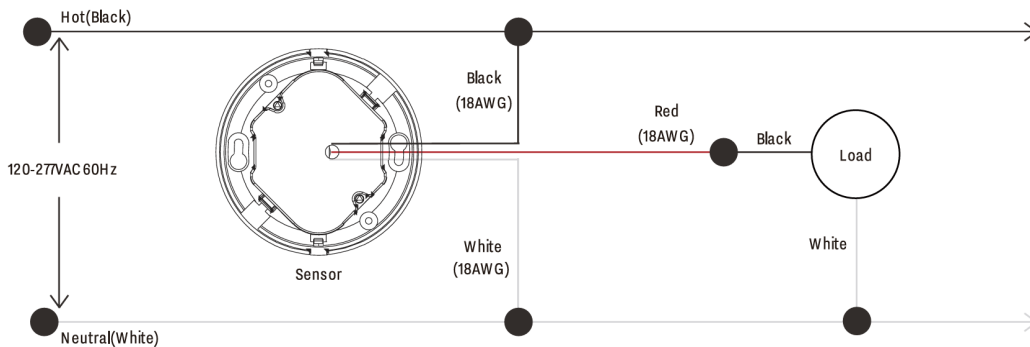
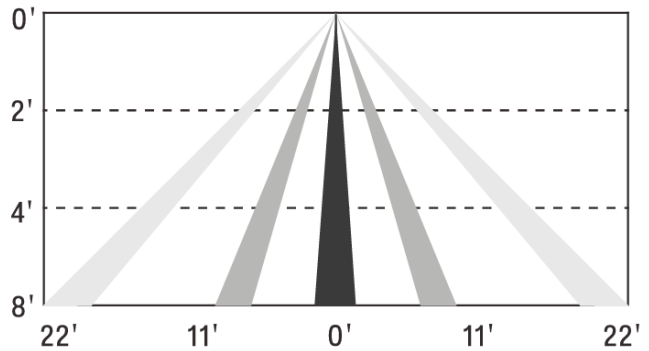

Application

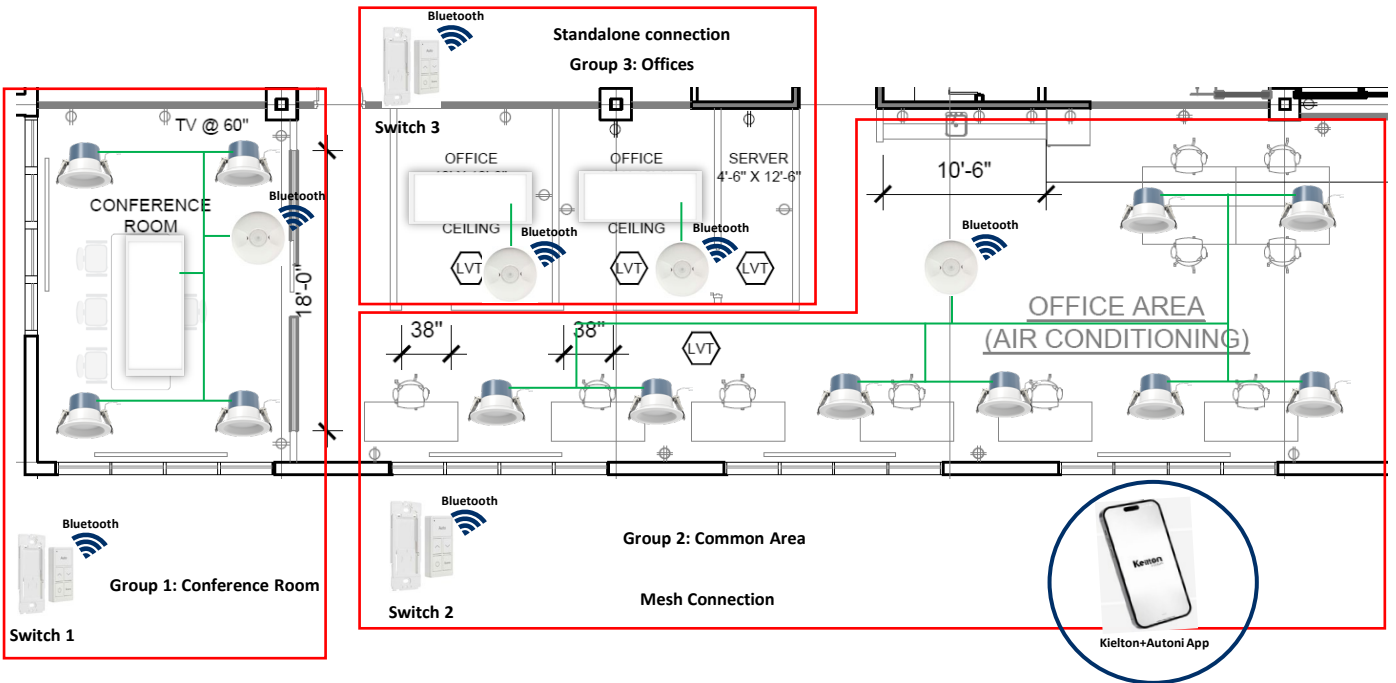

NOTES

- One sensor can be connected up to 800W total power fixtures (40 of 20W fixtures)
- CS107S does not need any additional accessory it has built in Bluetooth and output power 800W
- Download keilton application to control the fixture
- CS107S is considered as switch; and it is added through the switch menu.
- Group 1 can be Conference Room with downlights and flat panel assign the switch 1 to control the light fixture in this zone
- Group 2 can be Common Area with downlights controlled by switch 2
- Group 3 is Offices with one flat panel and motion sensor; stand alone connection
- The three groups can have different lighting schedule
- Motion sensor and day light harvesting parameters can be different for each group as required
- The dimming option is not available with this sensor.

Groups

- Create a new Group "ex: offices"

Switches

- Add CS107S as a switch
- You can connect up to 800W total power fixtures
- Turn on/off all the light simultaneously
- Specify motion sensor and day light harvesting parameters

App

Switches

- Add wall Switch to the system to control the group "ex: offices" (on/off)

More → Schedule

- Create multiple lighting schedule to turn the lights on or off

Menu



Zone Controller

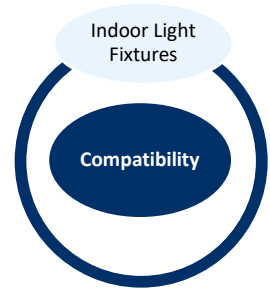
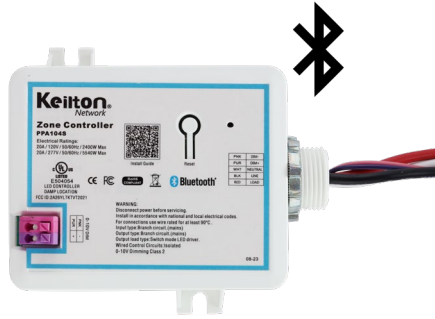

The PPA104S Series Bluetooth zone controllers feature a 20A relay for controlling higher capacity loads than standard fixture controllers.

Parameters	
Input Voltage	120-277V
Input Power	2400W @ 120V 5540W @ 277V
Output Current	20A Max
Dimming	Class 2, 0-10V
Bluetooth Transmit	200ft Max
Application	Indoor
Operating Temperature	-30°C to 55°C
IP Rating	IP20
Installation	Flat Surface
Knockout	½ inch US standard

Features
½ inch US standard knockout
high-efficiency switching power supply and a 20A relay
Can power up to 2400W @ 120V total power fixtures (ex: 100 of 24W fixtures)
Turn on/off and dim the fixtures
External 0-10V dimming port allows sink current 48.5 mA
Lighting schedule

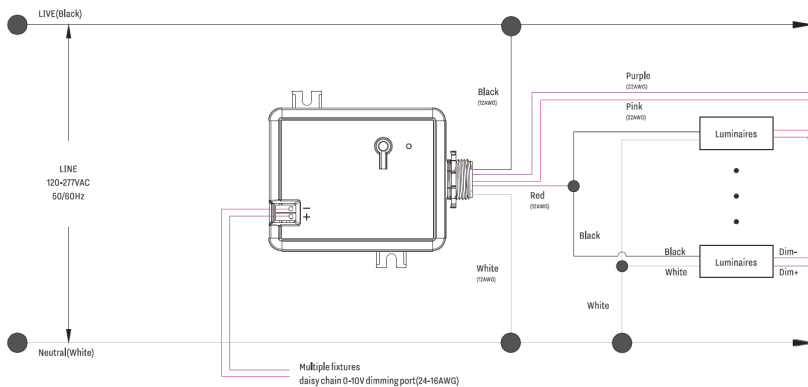

Application

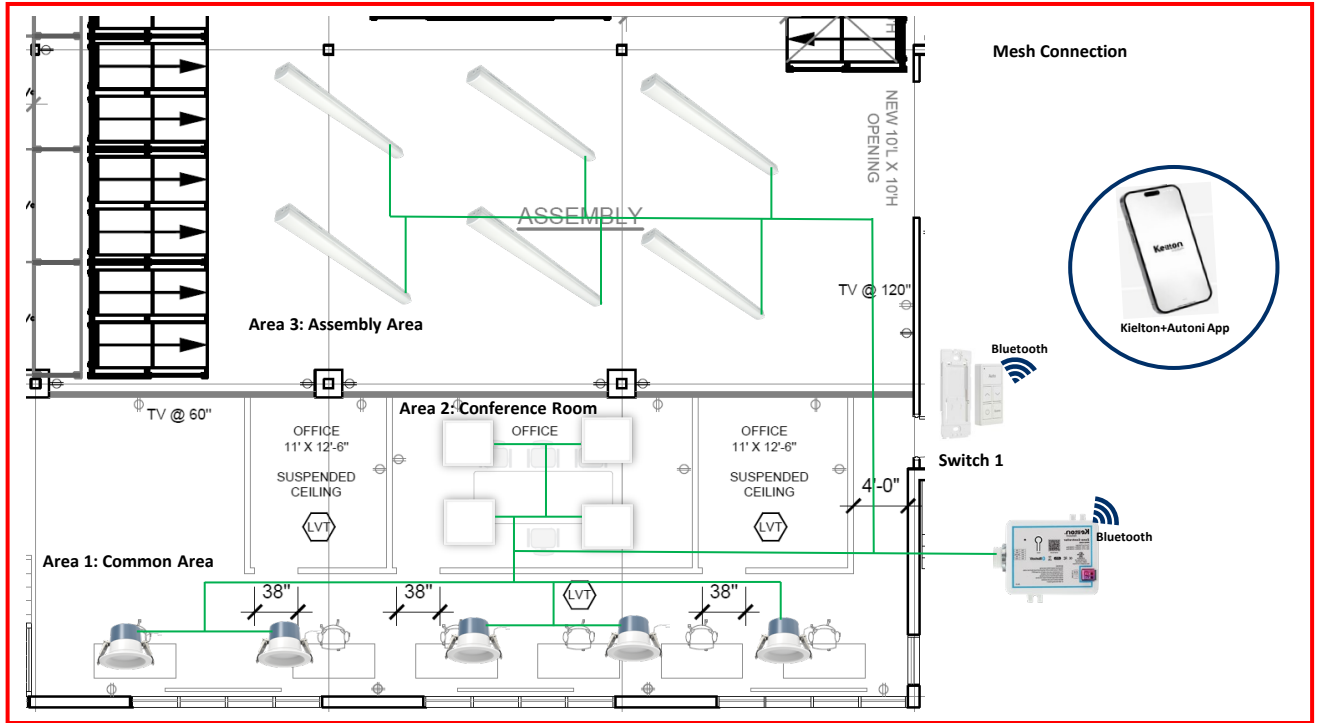

NOTES

- One Zone controller can be connected up to 2400W total power fixtures (100 of 24W fixtures)
- PPA104S does not need any additional accessory it has built in Bluetooth and output power 2400W
- Download keilton application to control the fixture
- PPA104S is considered as Light; and it is added through the Light menu.
- Area 1, 2 and 3 can be controlled as one light using the zone controller
- Assign switch 1 to control all the fixture; on/off, dimming and scene
- The three areas can have same lighting schedule are considered as one group and one light
- The dimming option is available with this controller.

Lights

- Add unlimited light/motion sensors in the app, in one or multiple zones

Groups

- Group up to 100 light in one group
- Turn on/off and dim all the light simultaneously

Switches

- Add wall Switch to the system to control the group (on/off | dimming | Scene | Auto)

Scenes

- Create desired scene with required brightness.

App

More → Schedule

- Create multiple lighting schedule to turn the lights on or off or activate the motion sensor/photocell

Menu



Wall Switch



The WP1025 is a 5-Key Battery-Powered Bluetooth Wall Switch battery-powered Bluetooth wireless wall switch that offers seamless control over your devices. It enables various functions, including ON/OFF, DIM+/DIM- for brightness adjustment, AUTO for automated control, and three customizable scene settings

Parameters	
Input Voltage	3V
Application	Indoor
Operating Temperature	0°C to 30°C
IP Rating	IP20
Installation	Flat Surface

Features
Bluetooth 5.0 network technology enables the switch to be linked to one or more light groups via the Keilton+autani app
3-scene scroll button
Separate DIM+/DIM-, ON/OFF, AUTO buttons
One group is assigned to one switch

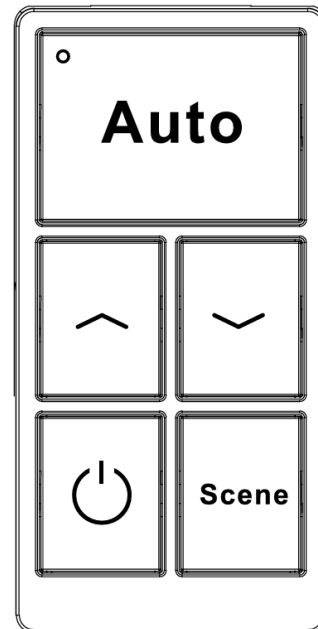
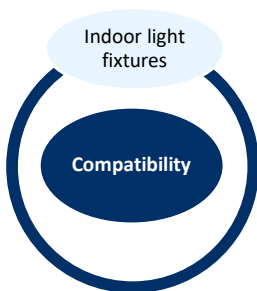

Wall Switch



The IWS102 series passive infrared (PIR) sensor switch detects human motion by sensing heat signature versus background. The sensor switch turns on the load when motion is detected. The load remains on during occupancy detection and turns off automatically after no motion is detected for a set time.

Parameters	
Input Voltage	120-277V
Application	Indoor
Operating Temperature	0°C to 55°C
IP Rating	IP20

Features
line Voltage Occ/Vacancy Sensor Bluetooth Wall Switch
Integrated PIR sensor and photo sensor with Hold-Off function
Day light harvesting

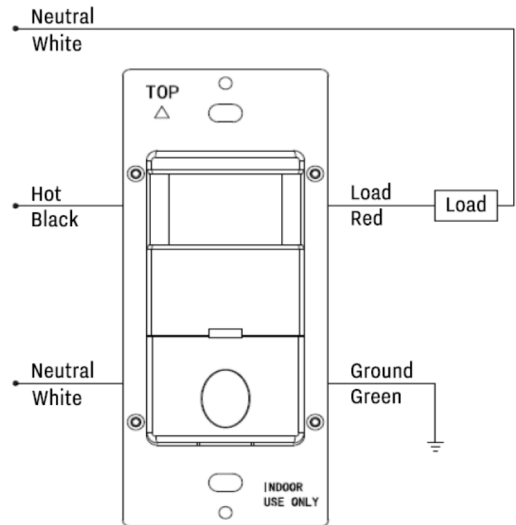
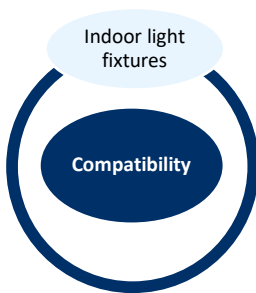

USB DONGLE

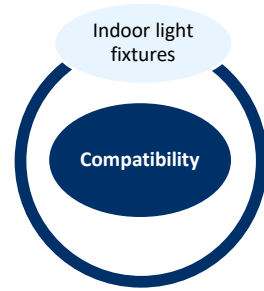

The CR01 series USB dongles elevate the capabilities of a Keilton+autani Bluetooth mesh network zone. Integrating a Real-Time Clock (RTC) and powered by a USB-A receptacle with backup power from the integrated CR2032 battery, both versions synchronize all devices within the zone, facilitating precise and consistent scheduling across the entire system.

Parameters	
Input Voltage	5V
Input Current	500mA Max
Bluetooth Transmit	100ft Max
Application	Indoor
Operating Temperature	-30°C to 55°C
IP Rating	IP20

Features
Energy monitoring functionality
collecting and analyzing the zone's energy consumption data to generate usage reports
empowers users with valuable insights into their energy usage
A raw log of energy consumption data is recorded every 15 minutes
Powered by USB-A receptacle
Embedded RTC to sync all devices in one Zone
Includes an internal battery to keep time during a power outage
Records energy consumption raw log in SIM Card (not included)

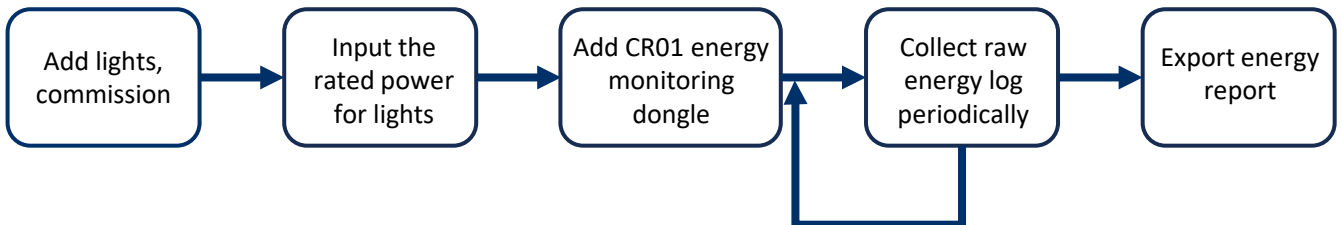

NOTE • Please refer to Keilton App Instruction for adding lights and commissioning

KEILTON+AUTANI APPLICATION

1st Create a zone
More → My Zones

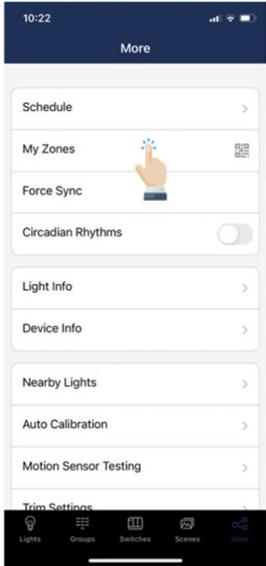

2nd Add lights
Lights → add lights

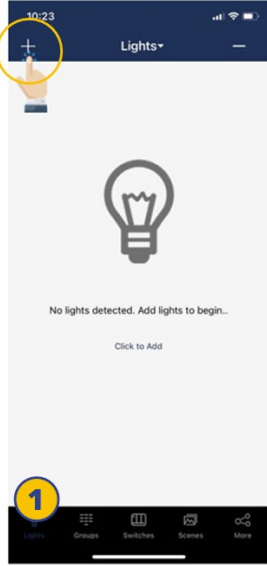

3rd Create Groups
Group → add lights

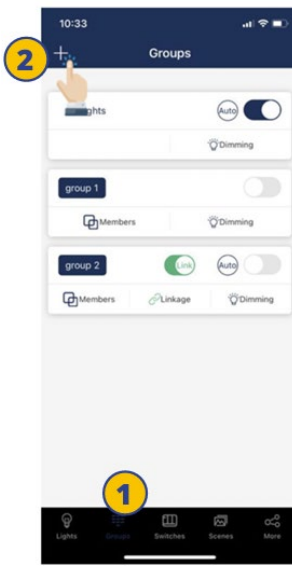

4th Adjust motion sensor and DLH
Group → adjust dimming/ and sensor settings

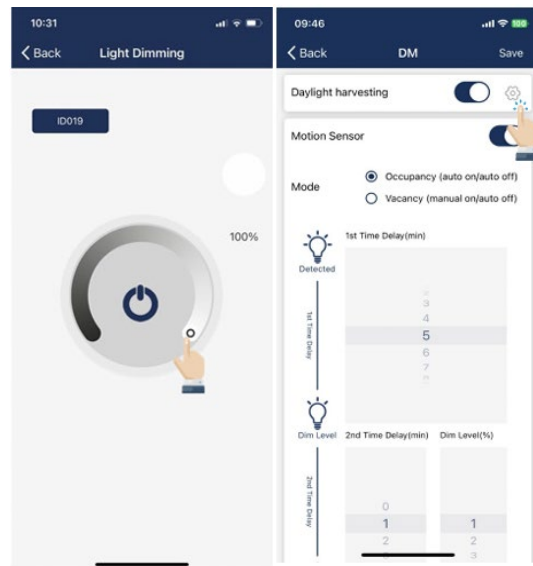

5th Create different scene
Scenes → Assign different scenes



6th Add switch
Switches → add switch to each group created

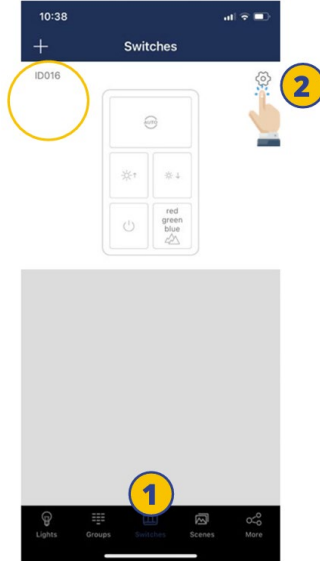

7th Create light schedule
More → Schedule
Add multiple light schedule to turn on off the light or the motion sensor

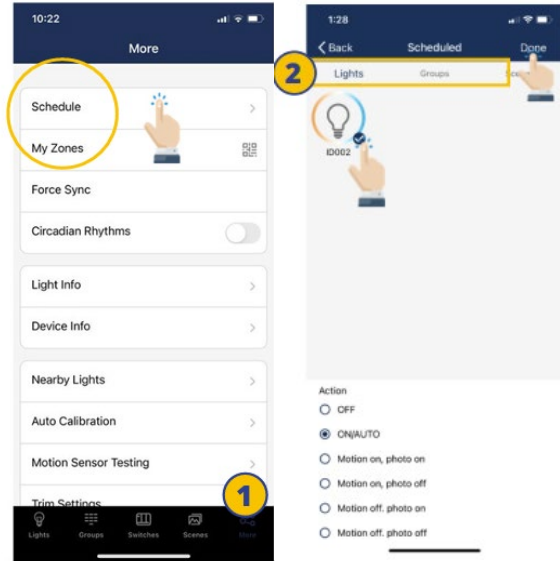

NOTE

- EFS106-AUX | FA102 / MWS105E | EFS107 / PPA103S | PPA104S are considered lights
- PPA104S | WP1025 are considered switches
- CR01-ETC USB Dongle should be connected to USB port to power on, and can be added through; more → Device info → add device
- For more details contact manufacture

CAPACITY LIMIT

Luminaires	Up to 100 lights (nodes) per zone. Unlimited zones available with each zone having its own sharable QR code with commands and setting info assignable for administrative or user level
Luminaire / Group	A light can be a member of up to 20 groups
Scene	Up to 32 scenes can be set to a light. Up to 127 scenes can be set to a zone
Schedule	Up to 32 schedules can be set to a zone
Switch	Up to 32 switches can be set to a zone. Note: switches and lights are calculated separately. Adding switches to a zone does not affect the maximum number of lights.

DAY LIGHT HARVESTING SETTINGS

DH Min Dim(%)	The minimum light level that daylight harvesting sensor can dim a luminaire to
Delay Time (S)	The time the sensor will wait to dim down the luminaire when ambient light has gone up
Speed (100ms)	How quick the sensor should dim the luminaire.

MOTION SENSOR MODES

Occupancy Mode	Auto turns on when motion is detected and auto turns off when T1/T2 timeout
Vacancy Mode	Auto turns off when T1/T2 timeout, lights must be manually turned on with switch
Note	T1 and T2 time delays may be set to infinite to prevent lights from turning off

MOTION SENSOR SETTINGS

1 st Time Delay (T1)	How long the fixture turns on when motion is detected
2 nd Time Delay (T2)	How long the fixture stays on after no motion is detected (after T1 ends)
Dim Level (%)	The dim level for the fixture during T2